

# 2023 TURNING TOOLS



# About GESAC

Xiamen Golden Egret Special Alloy Co., Ltd. (GESAC), founded in 1989, is a Sino-foreign joint venture with national high-tech, affiliated with XTC, which is one of six major rare earth groups in China. GESAC is committed to research & development, production and professional solutions providing of high-quality tungsten powder materials, cemented carbide, precision cutting tools and other tungsten products. Up to now, GESAC has become world-famous manufacturer and supplier of tungsten powder, cemented carbide and precision cutting tools products.

With the Integrated Product Development of complete tungsten industry chain, as well as a pragmatic and innovative management concept, GESAC has always maintained a strong momentum of development, providing the cost effective tungsten powder products and services for global users, offering the excellent products and perfect solutions for solving high hardness, high temperature resistance and wear resistance topics. Our brand "Golden Egret" has become one of the leading brand in the market, enjoying famous reputation in more than 40 countries and regions.

GESAC owns four production headquarters and one national level research center domestically, and three sales branches and one production base overseas. We undertook and completed several development programs independently, including the "National Science and Technology Support Programs", the "National Torch Program Projects", and the "National Key Projects" and so on. GESAC was awarded as "Key Enterprise for Strategic Emerging Industry", "Innovative Enterprise" and "Enterprise with Advanced Technology".



# Product Chain

GESAC has a complete tungsten product chain from tungsten ore to tungsten powder, cemented carbide products and cutting tools.

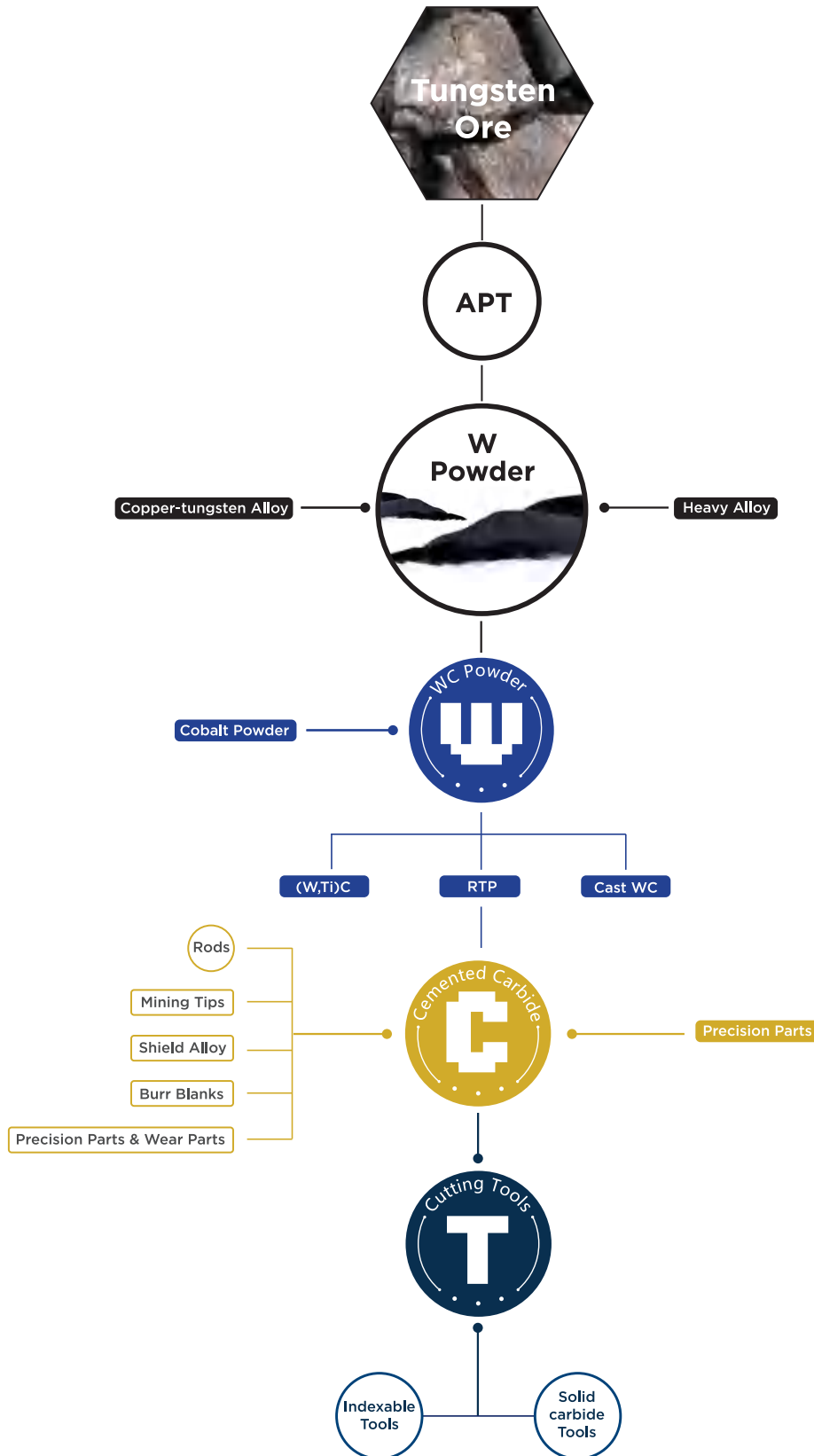

# Contents

<b>Insert Material</b> ——— <b>A</b>		<b>Turning Toolholders</b> ——— <b>E</b>	
Application Summary of Turning Grades	004	Overview of Turning Toolholders	139
Turning Grades	006	External Turning Toolholders Identification System	140
<b>General Turning</b> ——— <b>B</b>		External Turning Toolholders (Negative)	142
ISO Turning Inserts Identification System	014	External Turning Toolholders (Positive)	150
Overview of Turning Inserts	016	Internal Turning Toolholders Identification System	154
Turning Inserts (Negative)	034	Internal Turning Toolholders	156
Turning Inserts (Positive)	057	<b>Parting and Grooving Tools</b> ——— <b>F</b>	
Recommended Cutting Data (Negative)	068	Parting and Grooving Inserts Identification System	165
Recommended Cutting Data (Positive)	073	Parting and Grooving Holders Identification System	169
<b>Small Part Turning</b> ——— <b>C</b>		Overview of Parting and Grooving Inserts	174
Overview of Small Part Turning Inserts	076	Parting and Grooving Inserts	176
Small Part Turning Inserts (Negative)	088	Parting and Grooving Holders	188
Small Part Turning Inserts (Positive)	089	Recommended Cutting Data	200
Small Part Turning Inserts (Others)	104	<b>Threading Tools</b> ——— <b>G</b>	
Overview of Small Part Turning Holders	106	Threading Inserts Identification System	204
Small Part Turning Holders	107	Thread Turning Holders Identification System	207
Recommended Cutting Data	113	Overview of Threading Inserts	211
<b>PCBN/PCD Turning</b> ——— <b>D</b>		Thread Turning inserts	213
PCBN/PCD Turning Inserts Identification System	116	Thread Turning Holders	232
Overview of PCBN/PCD Turning Inserts	118	Recommended Cutting Data	238
PCBN Inserts (Negative)	119	(Cutting Passes and Radial Infeed)	
PCBN Inserts (Positive)	124	Recommended Cutting Data (Cutting Speed)	249
PCD Inserts (Positive)	133	<b>Appendix</b> ——— <b>H</b>	
Recommended Cutting Data	137	Chip Breaker comparison table	252
		Grade comparison table	254
		Cermet grade comparison table	256
		PCBN & PCD grade comparison table	257
		Small part inserts selection guide	258
		List of holder parts specifications	261

A

INSERT MATERIAL











# Application Summary of Turning Grades

Workpiece	ISO	Coated Carbide		Carbide
		CVD	PVD	
<b>P</b>	01	GPT6110	GAT7115, GAT7120	
	10	GPT6120, GP1105	GAT7115, GAT7120A	
	20	GPT6130, GP1115, GP1120	GAT7115, GAT7120A, GAT7125, GA4330, GA4230	
	30	GP1225, GP1130, GP1135	GAT7115, GAT7120A, GAT7125, GA4330, GA4230	
	40		GAT7125, GA4330, GA4230	
	50		GAT7125, GA4330, GA4230	
<b>M</b>	01			
	10	GM1115	GM3215, GAT7115, GAT7120	
	20	GM1125, GM1230	GM3215, GM3220, GM3225, GAT7115, GAT7120, GA4330, GA4230	
	30		GM3215, GM3220, GM3225, GAT7115, GAT7120, GA4330, GA4230	
	40		GM3215, GM3220, GM3225, GAT7115, GAT7120, GA4330, GA4230	
	50		GM3215, GM3220, GM3225, GAT7115, GAT7120, GA4330, GA4230	
<b>K</b>	01			
	10	GK1115		
	20	GK1120, GK1125	GA4330, GA4230	
	30		GA4330, GA4230	
	40		GA4330, GA4230	
<b>N</b>	01			
	10		GNT7120	GN9110, GN9120, GN9130
	20		GNT7120	GN9110, GN9120, GN9130
	30		GNT7120	GN9110, GN9120, GN9130
	40		GNT7120	GN9110, GN9120, GN9130
<b>S</b>	01			
	10		GST7120, GST7115, GST7130, GS3115, GS3125	GS9125
	20		GST7120, GST7115, GST7130, GS3115, GS3125	GS9125
	30		GST7120, GST7115, GST7130, GS3115, GS3125	GS9125
	40		GST7120, GST7115, GST7130, GS3115, GS3125	GS9125
<b>H</b>	01			
	10			
	20			
	30			
	40			





	Cermet	Coated Cermet	CBN	Coated CBN	PCD
	GP91TM GP92TM	GP31TM			
	GP91TM GP92TM	GP31TM			
	GP91TM	GP31TM	BKN115P BKN225Z BKN225S	BKC120P	
					DNN125P
			BSN115P		
			BHN225S	BHC210P BHC225P BHC115P BHC125P BHC135P BHC215Z BHC225Z	

## Turning Grades



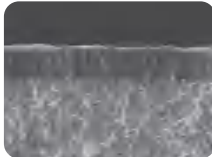



## CVD Coated Carbide

ISO	Grade	Grade Color	Grade Microstructure	Grade Feature
P	GPT6110	Champagne		<ul style="list-style-type: none"> <li>•Brand new CVD coating with special post-treatment technology and high hot hardness cemented carbide substrate, provides the grade with superior adhesion resistance and excellent wear resistance.</li> <li>•Recommended for Continuous conditions of carbon steels and alloy steels at high speeds.</li> </ul>
	GPT6120	Champagne		<ul style="list-style-type: none"> <li>•Brand new CVD coating with unique low-stress post-treatment, matching cemented carbide substrate with perfect thermo-plastic deformation resistance, guarantees the high wear resistance and toughness.</li> <li>•Recommended for carbon steels and alloy steels in wide cutting conditions at medium to high speeds.</li> </ul>
	GPT6130	Champagne		<ul style="list-style-type: none"> <li>•New cemented carbide with special cobalt enrichment controlling technology, combined with new CVD coating and advanced post-treatment, greatly improves the edge breakage.</li> <li>•Recommended for most Intermittent conditions of carbon steels and alloy steels at medium speeds.</li> </ul>
	GP1105	Ash black		<ul style="list-style-type: none"> <li>•Combining the ultrafine Al<sub>2</sub>O<sub>3</sub> and MT-TiCN coatings with gradient cemented carbide substrate, provides the new grade with excellent wear resistance.</li> <li>•Recommended for stable finishing turning of carbon steels &amp; alloy steels, including steels parting and grooving processing.</li> </ul>
	GP1115	Yellow		<ul style="list-style-type: none"> <li>•Ultrafine MT-TiCN and Al<sub>2</sub>O<sub>3</sub> coatings, matching smooth indexed TiN layer and good wear resistant substrate, ensures the grade with long service life.</li> <li>•Recommended for stable finishing to semi-finishing of carbon steels and alloy steels.</li> </ul>
	GP1120	Golden		<ul style="list-style-type: none"> <li>•Ultrafine MT-TiCN and Al<sub>2</sub>O<sub>3</sub> coatings, matching smooth indexed TiN layer and good wear resistant substrate, ensures the grade with long service life.</li> <li>•Recommended for stable finishing to semi-finishing of carbon steels and alloy steels.</li> </ul>
	GP1225	Yellow		<ul style="list-style-type: none"> <li>•Combined columnar grain MT-TiCN, Al<sub>2</sub>O<sub>3</sub> and TiN coating with a gradient substrate provides excellent wear resistance and toughness.</li> <li>•Recommended for semi-finishing to medium roughing of steels and alloy steels.</li> </ul>
	GP1130	Golden		<ul style="list-style-type: none"> <li>•Fine MT-TiCN and tough Al<sub>2</sub>O<sub>3</sub> in combination with high toughness gradient substrate ensures the good resistance to cutting edge breakage.</li> <li>•Recommended for roughing of carbon steels and alloy steels at low and medium cutting speeds.</li> </ul>
	GP1135	Yellow		<ul style="list-style-type: none"> <li>•Well controlled MT-TiCN, Al<sub>2</sub>O<sub>3</sub> and TiN coating with well wear resistance combined with a gradient carbide substrate improves the edge security and high toughness.</li> <li>•Recommended for roughing of carbon steels and alloy steels at high metal removal rates.</li> </ul>

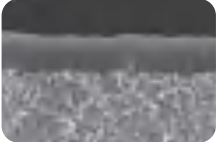





ISO	Grade	Grade Color	Grade Microstructure	Grade Feature
<b>M</b>	GM1115	Shiny golden		<ul style="list-style-type: none"> <li>• Combined nano-columnar MT-TiCN, thin Al<sub>2</sub>O<sub>3</sub>, bright TiN and a gradient substrate gives excellent wear resistance, low-stress post-treatment provides less built-up-edge and longer tool life.</li> <li>• Recommended for finishing to semi-finishing of stainless steels.</li> </ul>
	GM1125	Shiny golden		<ul style="list-style-type: none"> <li>• The combination of a tough carbide alloy matrix and TiCN/TiN coating provides excellent wear resistance. Special surface treatment technology that effectively reduces cutting resistance and suppresses chip buildup, tool life can be extended, making it suitable for semi-finishing stainless steel.</li> </ul>
	GM1230	Shiny golden		<ul style="list-style-type: none"> <li>• Thinner Al<sub>2</sub>O<sub>3</sub> layer and nano-columnar MT-TiCN layer with a gradient substrate. Post-treatment to reduce cutting force and less built-up edge, which in order to enhance the stability.</li> <li>• Recommended for continuous and lightly interrupt processing in stainless steel.</li> </ul>
<b>K</b>	GK1115	Ash black		<ul style="list-style-type: none"> <li>• High wear resistant substrate with fine grain, combined with thick Al<sub>2</sub>O<sub>3</sub> coating and smoothy post-treatment, provides the grade with outstanding wear resistance and high edge toughness on processing grey cast irons.</li> <li>• Recommended for finishing machining of grey cast irons.</li> </ul>
	GK1120	Ash black		<ul style="list-style-type: none"> <li>• Thicker Al<sub>2</sub>O<sub>3</sub> coating combined with fine grained substrate provides high edge security and toughness.</li> <li>• Recommended for finishing to semi-finishing of nodular cast irons.</li> </ul>
	GK1125	Ash black		<ul style="list-style-type: none"> <li>• Thick MT-TiCN coating and ultrafine Al<sub>2</sub>O<sub>3</sub>, matching high wear resistant cemented carbide substrate with fine grain, helps to improve toughness and great wear resistance.</li> <li>• Recommended for interrupted roughing of nodular cast irons.</li> </ul>



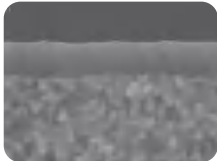

## PVD Coated Carbide

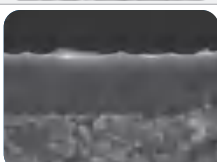
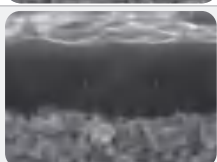
ISO	Grade	Grade Color	Grade Microstructure	Grade Feature
<b>M</b>	GM3215	Purplish grey		<ul style="list-style-type: none"> <li>• Brand new PVD TiAlN coating combined with submicron grained WC-Co cemented carbide substrate, provides the new grade with excellent wear resistance and heat resistance.</li> <li>• Recommended for finishing of stainless steels and heat resistant alloys in stable cutting conditions at medium speeds.</li> </ul>
	GM3220	shiny orange		<ul style="list-style-type: none"> <li>• New nano-structured PVD coating matching high cobalt cemented carbide substrate, gives the grade with excellent wear resistance and high hot hardness.</li> <li>• Recommended for Continuous and light or medium Intermittent of stainless steels and soft steels at medium to low cutting speeds.</li> </ul>
	GM3225	Purplish grey		<ul style="list-style-type: none"> <li>• The combination of optimized TiAlN coating and submicron grained carbide substrate with high Co content, provides superior adhesion and toughness.</li> <li>• Recommended for semi-finishing of stainless steels and threading of steels, stainless steels, etc.</li> </ul>
<b>S</b>	GST7120	Purplish grey		<ul style="list-style-type: none"> <li>• New higher adhesion and wear-resistance PVD coating with submicro grain substrate, which increase grade wear resistance, oxidation resistance, and processing stability.</li> <li>• Recommended for medium and high speed processing in nickel based high-temperature alloys.</li> </ul>
	GST7115	Yellow		<ul style="list-style-type: none"> <li>• New nano structure PVD coating with higher hot hardness and anti-plastic deformation substrate. Special post-treatment, which make excellent high temperature wear resistance and adhesive wear resistance.</li> <li>• Recommended for low and medium speed finishing to semi-finishing processing in nickel based high-temperature alloys, good surface quality.</li> </ul>
	GST7130	Yellow		<ul style="list-style-type: none"> <li>• New PVD coating with high Co submicro grain substrate, which have good adhesion, extremely high toughness, and cutting edge strength.</li> <li>• Recommended for low and medium speed roughing in nickel based high-temperature alloys, good surface quality.</li> </ul>
	GS3115	Purplish red		<ul style="list-style-type: none"> <li>• Fine grained cemented carbide substrate, matching PVD coating with high aluminum content, have excellent adhesion and wear resistance.</li> <li>• Recommended for semi-finishing or finishing of stainless steels and heat resistant alloys.</li> </ul>
	GS3125	Purplish grey		<ul style="list-style-type: none"> <li>• TiAlN PVD coating with higher hot hardness and anti-plastic deformation substrate, which have good antioxidant performance and adhesive wear resistance.</li> <li>• Recommended for medium speed finishing to semi-finishing processing in high temperature alloy, titanium alloy, stainless steel.</li> </ul>



PVD Coated Carbide

ISO	Grade	Grade Color	Grade Microstructure	Grade Feature
N    /    	GNT7120	Silver		<ul style="list-style-type: none"> <li>The newly upgraded coating has extremely high hardness and excellent adhesion, and has almost no affinity with non-ferrous metals. It is paired with a high wear-resistant hard alloy matrix to achieve efficient processing of non-ferrous metals such as aluminum alloys.</li> <li>Recommend universal processing of non-ferrous metals such as copper and aluminum alloys.</li> </ul>
	GAT7115	Gray		<ul style="list-style-type: none"> <li>New nanostructured PVD coating combine with micro-grain cemented carbide substrate and special surface treatment, provides outstanding wear resistance, oxidation resistance and machining stability.</li> <li>Suitable for steel and stainless steel in general cutting condition with medium or high speed.</li> </ul>
	GAT7120	Purplish red		<ul style="list-style-type: none"> <li>High wear-resistant PVD coating with ultra-fine grained cemented carbide substrate, provides excellent wear resistance at medium and low speed, achieving precision machining.</li> <li>Suitable for steel and stainless steel in stable cutting condition with low or medium speed.</li> </ul>
	GAT7120A	Purplish red		<ul style="list-style-type: none"> <li>Optimized micro-grain carbide substrate with high wear resistant PVD coating, provides high versatility, for steel cutting has excellent performance.</li> <li>Suitable for general cutting of steel materials.</li> </ul>
	GAT7125	Gray		<ul style="list-style-type: none"> <li>New generation coating with new PVD technology, combined with high-Co cemented carbide substrate, provides excellent toughness and cutting edge strength.</li> <li>Suitable for steel and stainless steel in unstable cutting condition.</li> </ul>
	GA4330	Yellow		<ul style="list-style-type: none"> <li>New TiAlN coating with fine grain substrate, which increase wear-resistance and cutting stability.</li> <li>Recommended for medium hardness steel and stainless steel processing.</li> </ul>
	GA4230	Purplish red		<ul style="list-style-type: none"> <li>PVD TiAlN coating with high toughness substrate provides excellent wear resistance and high edge security for a broad application area.</li> <li>Recommended as general choice for parting and grooving of steels.</li> </ul>









## Carbide

ISO	Grade	Grade Color	Grade Microstructure	Grade Feature
S	GS9125	Uncoated		<ul style="list-style-type: none"> <li>•Uncoated fine grain substrate has a good balance of wear resistance and toughness.</li> <li>•Recommended as the first choice for titanium alloys, and even for semi-finishing of titanium alloys grooving.</li> </ul>
	GN9110	Uncoated		<ul style="list-style-type: none"> <li>•Uncoated fine-grained grade has great wear resistance.</li> <li>•Recommended for finishing of aluminum alloys and copper alloys at high cutting speeds.</li> </ul>
N	GN9120	Uncoated		<ul style="list-style-type: none"> <li>•Fine-grained substrate with special surface treatment improves the wear resistance and less built-up-edge.</li> <li>•Recommended for finishing to semi-finishing of aluminum alloys, copper alloys and other non-ferrous materials.</li> </ul>
	GN9130	Uncoated		<ul style="list-style-type: none"> <li>•Uncoated fine-grained substrate grade has quite good wear resistance and toughness.</li> <li>•Recommended for semi-finishing of coppers and aluminum alloys.</li> </ul>



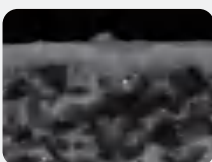

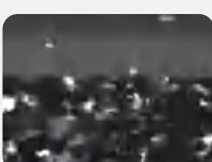
## Cermets

ISO	Grade	Grade Color	Grade Microstructure	Grade Feature
P	GP31TM	Purplish grey		<ul style="list-style-type: none"> <li>•Thin PVD coating and cermet have excellent resistance to built-up-edge and plastic deformation, which ensures the high surface quality.</li> <li>•Recommended for finishing of carbon steels and low alloy steels at high cutting speeds.</li> </ul>
	GP91TM	Uncoated		<ul style="list-style-type: none"> <li>•Uncoated cermet has well wear resistance and toughness, even excellent high surface quality.</li> <li>•Recommended for finishing of carbon steels and low alloy steels when good surface quality is required.</li> </ul>
	GP92TM	Uncoated		<ul style="list-style-type: none"> <li>•Enhanced toughness, significantly improving anti chipping performance, enhancing tool versatility, achieving stable and long life machining, while achieving excellent machining surface quality.</li> <li>•Suitable for continuous precision machining of carbon steel and low alloy steel.</li> </ul>

PCBN&PCD

ISO	Grade	Grade Color	Grade Microstructure	Grade Feature
K	BKN115P	Uncoated		<ul style="list-style-type: none"> <li>•Uncoated grade with high hardness has excellent wear resistance.</li> <li>•Recommended for finishing of grey cast irons and valve seat machining.</li> </ul>
	BKC120P	Purplish grey		<ul style="list-style-type: none"> <li>•Outstanding PVD coating can reduce the friction between cutting edge and workpiece, which improves the wear resistance dramatically.</li> <li>•Recommended for finishing of nodular cast irons.</li> </ul>
	BKN225Z BKN225S	Uncoated		<ul style="list-style-type: none"> <li>•Excellent impact and wear resistance, it has strong universality.</li> <li>•Semi-finishing and finishing of grey cast iron and high hard alloy cast iron.</li> </ul>
S	BSN115P	Uncoated		<ul style="list-style-type: none"> <li>•Uncoated grade has a high edge toughness and chemical stability</li> <li>•Recommended for finishing of powder metallurgy parts.</li> </ul>
H	BHC115P	Purplish grey		<ul style="list-style-type: none"> <li>•New TiAlN coating provides the good resistance to notch wear, which reduces the roughness of the workpiece surface.</li> <li>•Recommended for finishing of quenched steels when high surface quality and close tolerances are required.</li> </ul>
	BHC125P	Purplish grey		<ul style="list-style-type: none"> <li>•CBN substrates with TiAlN coating have great toughness and wear resistance, which is capable of longer tool life and more stability.</li> <li>•Recommended for general machining of quenched steels.</li> </ul>
	BHC135P	Purplish grey		<ul style="list-style-type: none"> <li>•CBN substrate with high edge toughness matching TiAlN coating greatly improves wear resistance.</li> <li>•Recommended for interrupted processing of quenched steels.</li> </ul>
	BHC210P	Bronze		<ul style="list-style-type: none"> <li>•The new double-layer nanostructure AlTiSiN coating has excellent heat resistance and wear resistance, achieving stable performance and excellent surface roughness.</li> <li>•Suitable for precision machining conditions with high requirements for surface roughness and dimensional accuracy of quenched steel.</li> </ul>

## PCBN&amp;PCD

ISO	Grade	Grade Color	Grade Microstructure	Grade Feature
<b>H</b>	BHC215Z	Bronze		<ul style="list-style-type: none"> <li>•The new TiAlSiN coating has good chemical wear resistance and improves the service life at high linear speed. Low content fine crystalline CBN matrix, with excellent wear resistance and red hardness.</li> <li>•Suitable for continuous to light intermittent machining of hardened steel.</li> </ul>
	BHC225P	Bronze		<ul style="list-style-type: none"> <li>•The new double layered nanostructured AlTiSiN coating is coated on a specially designed CBN substrate, which has strong toughness and further improves wear resistance, achieving more stable processing and long service life.</li> <li>•Suitable for universal processing of various quenched steels.</li> </ul>
	BHC225Z	Bronze		<ul style="list-style-type: none"> <li>•The new TiAlSiN coating has good chemical wear resistance and improves the service life at high linear speed. A multi-modal grained CBN substrate, has superior toughness and greatly improved wear resistance, and can achieve more stable machining and longer tool life.</li> <li>•Suitable for general processing of hardened steel.</li> </ul>
	BHN225S	Uncoated		<ul style="list-style-type: none"> <li>•A multi-modal grained CBN substrate, has superior toughness and greatly improved wear resistance, and can achieve more stable machining and longer tool life.</li> <li>•Suitable for general processing of hardened steel.</li> </ul>
<b>N</b>	DNN125P	Uncoated		<ul style="list-style-type: none"> <li>•Medium grained diamond has excellent wear resistance and toughness.</li> <li>•Recommended for high efficient finishing of aluminums, coppers, plastics and graphite materials.</li> </ul>

B

GENERAL TURNING

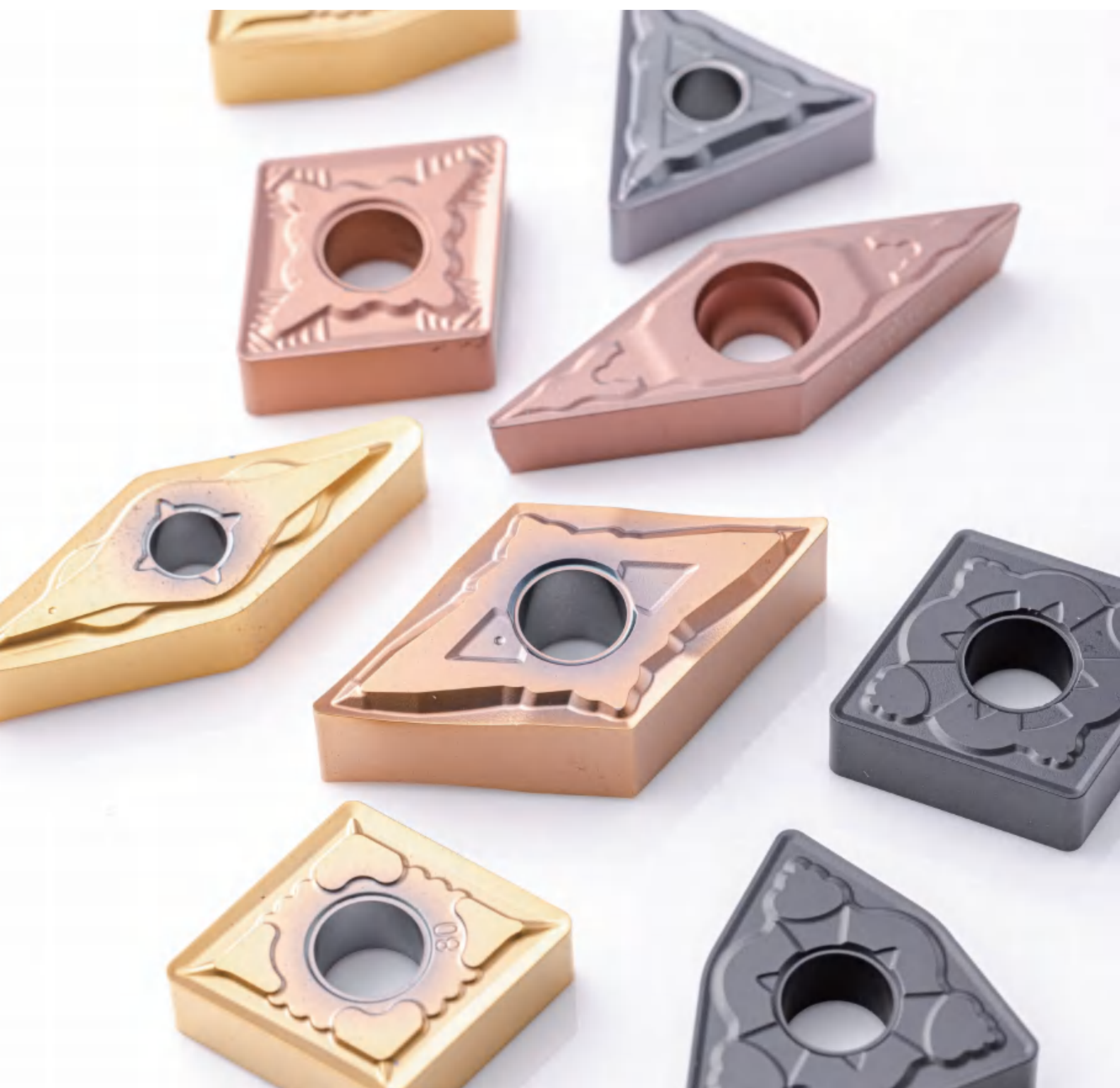

# ISO Turning Inserts Identification System

Symbol	Shape	Corner Angle	Shape	Symbol	Relief Angle	Tolerance (mm)			Tolerance (inch)		
						Corner Height (m)	Thickness (s)	I.C.dia. (Ød)	Corner Height (m)	Thickness (s)	I.C.dia. (Ød)
H	Hexagon	120°		A	3°	±0.005	±0.025	±0.025	±0.0002	±0.001	±0.001
O	Octagon	135°		B	5°	±0.005	±0.025	±0.013	±0.0002	±0.001	±0.0005
P	Pentagon	108°		C	7°	±0.013	±0.025	±0.025	±0.0005	±0.001	±0.001
S	Square	90°		D	15°	±0.013	±0.025	±0.013	±0.0005	±0.001	±0.0005
T	Triangle	60°		E	20°	±0.025	±0.025	±0.025	±0.001	±0.001	±0.001
C	Rhombic	80°		F	25°	±0.025	±0.13	±0.025	±0.001	±0.005	±0.001
D		55°		G	30°	±0.025	±0.13	±0.025	±0.001	±0.005	±0.001
E		75°		N	0°	±0.005	±0.025	±0.05~±0.13	±0.0002	±0.001	±0.002~±0.005
F		50°		P	11°	±0.013	±0.025	±0.05~±0.13	±0.0005	±0.001	±0.002~±0.005
M		86°		O	其他	±0.025	±0.025	±0.05~±0.13	±0.0005	±0.001	±0.002~±0.005
V		35°				±0.013	±0.025	±0.05~±0.13	±0.0005	±0.001	±0.002~±0.005
W	Trigon	80°		L		±0.025	±0.025	±0.05~±0.13	±0.001	±0.001	±0.002~±0.005
L	Rectangle	90°		M		±0.08~±0.18	±0.13	±0.05~±0.13	±0.003~±0.007	±0.005	±0.002~±0.005
A	Parallelogram	85°		N		±0.08~±0.18	±0.025	±0.05~±0.13	±0.003~±0.007	±0.001	±0.002~±0.005
B		82°		U		±0.13~±0.38	±0.13	±0.08~±0.25	±0.005~±0.015	±0.005	±0.003~±0.01
K		55°									
R	Round	—									



**T N M G 22**



④Hole/Chipbreaker Symbol					
Symbol	Hole	Hole Shape	Chlpp-reaker	Shape	
N	Without	—	Without		
R			Single-sided		
F			Double-sided		
A	With Hole	With Hole	Without		
M			Single-sided		
G			Double-sided		
W			With Hole and One Countersink 40-60°	Without	
T			Single-sided		
Q			With Hole and Two Countersink 40-60°C	Without	
U	With Hole and One Countersink 70-90°C	With Hole	Double-sided		
B			Without		
H			Double-sided		
C	With Hole and Two Countersink 70-90°C	With Hole	Without		
J			Double-sided		
X	—	—	—		

⑤Edge Length Symbol (ISO) (mm)																
R		S		C		W		T		D		V		K		I. C. Size (mm)
Symbol	Length	Symbol	Length	Symbol	Length	Symbol	Length	Symbol	Length	Symbol	Length	Symbol	Length	Symbol	Length	
		03	3.97	03	4.0			06	6.9	4	4.8					3.97
		04	4.76	04	4.8			08	8.2	5	5.8					4.76
05	5	--	--	--	--	--	--	--	--	--	--	--	--	--	--	5
		05	5.56	05	5.6	03	3.8	09	9.6	6	6.8					5.56
06	6	--	--	--	--	--	--	--	--	--	--	--	--	--	--	6
		06	6.35	06	6.5	04	4.3	11	11	7	7.8	11	11.2			6.35
		07	7.94	08	8.1	05	5.4	13	13.8	9	9.7					7.94
08	8	--	--	--	--	--	--	--	--	--	--	--	--	--	--	8
09	9.525	09	9.525	09	9.7	06	6.5	16	16.5	11	11.6	16	16.6	16	19.7	9.525
10	10	--	--	--	--	--	--	--	--	--	--	--	--	--	--	10
12	12	--	--	--	--	--	--	--	--	--	--	--	--	--	--	12
12	12.7	12	12.7	12	12.9	08	8.7	22	22	15	15.5	22	22.1			12.7
15	15.875	15	15.875	16	16.1	10	10.9	27	27.5	19	19.4					15.875
16	16	--	--	--	--	--	--	--	--	--	--	--	--	--	--	16
19	19.05	19	19.05	19	19.3	13	13	33	33	23	23.3					19.05
20	20	--	--	--	--	--	--	--	--	--	--	--	--	--	--	20
		22	22.225	22	22.6			38	38.5	27	27.1					22.225
25	25	--	--	--	--	--	--	--	--	--	--	--	--	--	--	25
25	25.4	25	25.4	25	25.8			44	44	31	31					25.4
31	31.75	31	31.75	32	32.2			55	55	38	38.8					31.75
31	32	--	--	--	--	--	--	--	--	--	--	--	--	--	--	32



Insert Shape: H,O,P,S,T,C,E,M,W,R									
I. C. Size (mm)	Tolerance of I. C. Size(∅d) (mm)		Tolerance of Corner Height (mm)		I. C. Size (inch)	Tolerance of I. C. Size(∅d) (mm)		Tolerance of corner Height (mm)	
	J,K,L,M,N	U	M,N	U		Class J,K,L,M,N	Class U	Class J,K,L,M,N	Class U
6.35	±0.05	±0.08	±0.08	±0.13	0.250	±0.002	±0.003	±0.003	±0.005
9.525					0.375				
12.7	±0.08	±0.13	±0.13	±0.2	0.500	±0.003	±0.005	±0.005	±0.008
15.875					0.625				
19.05	±0.1	±0.18	±0.15	±0.27	0.750	±0.004	±0.007	±0.006	±0.011
25.4					1.000				
31.75	±0.13	±0.25	±0.18	±0.38	1.250	±0.005	±0.010	±0.007	±0.015
32					1.260				

Symbol	Thickness (mm)
01	1.59
02	2.38
T2	2.78
03	3.18
T3	3.97
04	4.76
05	5.56
06	6.35
07	7.94
09	9.52
ⒸThickness Symble	

Insert Shape: D					
Inscribed Circle Size		Tolerance of I. C. Size		Tolerance of Corner Height	
mm	in	mm	in	mm	in
6.35	0.250	±0.05	±0.002	±0.11	±0.004
9.525	0.375	±0.05	±0.002	±0.11	±0.004
12.7	0.500	±0.08	±0.003	±0.15	±0.006
15.875	0.625	±0.10	±0.004	±0.18	±0.007
19.05	0.750	±0.10	±0.004	±0.18	±0.007

Insert Shape: V					
Inscribed Circle Size		Tolerance of I. C. Size		Tolerance of Corner Height	
mm	in	mm	in	mm	in
6.35	0.250	±0.05	±0.002	±0.15	±0.006
9.525	0.375	±0.05	±0.002	±0.15	±0.006
12.7	0.500	±0.08	±0.003	±0.20	±0.008
15.875	0.625	±0.10	±0.004	±0.27	±0.011
19.05	0.750	±0.10	±0.004	±0.27	±0.011



**04 08 - HK**



Inscribed Circle Size (mm)
Insert Thickness (S)
Corner Height (m)





























⑦Corner Ro Symbol	
Symbol	Corner-R (mm)
00	0.03
02	0.2
04	0.4
08	0.8
12	1.2
16	1.6
20	2.0
24	2.4
28	2.8
32	3.2

⑧Chipbreaker Symbol
Chipbreaker Symbol

# Overview of Turning Inserts

## Turning Inserts (Negative)





















Chip Breaker	Features	Application Range	Cross Section Chip Breaker
QF	<ul style="list-style-type: none"> <li>• QF for finishing of general steel and alloy steel.</li> <li>• Curved edge, sharp cutting edge, good chip control and fine surface finish due to curved edge.</li> </ul>		
TF	<ul style="list-style-type: none"> <li>• TF for finishing of steel and alloy steel.</li> <li>• Curved cutting edge design, shaper cutting edge, low cutting resistance, high surface finish, and good chip breaking and removal effect.</li> </ul>		
GF	<ul style="list-style-type: none"> <li>• GF for finishing of general steel and alloy steel.</li> <li>• Sharp tool nose and strong cutting edge and good chip control under small cutting depth.</li> </ul>		
SPL	<ul style="list-style-type: none"> <li>• SPL for light cutting of general steel and alloy steel;</li> <li>• Wide range of chip-breaking and versatility.</li> </ul>		
QM	<ul style="list-style-type: none"> <li>• QM for semi-finishing of general steel and alloy steel.</li> <li>• The design of step and wavy boss widens the range of chip breaking.</li> </ul>		

	80°Rhombic	55°Rhombic	90°Square	60°Regular Triangle	35°Rhombic	80°Trigon
						
	CNMG-QF P034	DNMG-QF P039	SNMG-QF P043	TNMG-QF P047	VNMG-QF P051	WNMG-QF P053
						
	CNMG-TF P034	DNMG-TF P039		TNMG-TF P047	VNMG-TF P051	WNMG-TF P053
						
	CNMG-GF P034	DNMG-GF P039	SNMG-GF P043	TNMG-GF P047	VNMG-GF P051	WNMG-GF P053
						
	CNMG-SPL P034	DNMG-SPL P039		TNMG-SPL P047	VNMG-SPL P051	WNMG-SPL P053
						
	CNMG-QM P035	DNMG-QM P040	SNMG-QM P043	TNMG-QM P047	VNMG-QM P051	WNMG-QM P054

# Overview of Turning Inserts

## Turning Inserts (Negative)



































Chip Breaker	Features	Application Range	Cross Section Chip Breaker
GM	<ul style="list-style-type: none"> <li>• GM for semi-finishing of general steel and alloy steel.</li> <li>• Strong flat cutting edge with good strength.</li> </ul>		
SV	<ul style="list-style-type: none"> <li>• SV for semi-finishing of general steel and alloy steel.</li> <li>• Throughout groove and wide chip groove make cutting available in unstable working conditions.</li> <li>• Long chip groove allows high depth of cut.</li> </ul>		
QR	<ul style="list-style-type: none"> <li>• QR for rough cutting action of carbon steel, cast steel and alloy steel.</li> <li>• Variable rake angle and land provides enough edge sharpness and strength at different depth of cut.</li> </ul>		
QH	<ul style="list-style-type: none"> <li>• QH for heavy cutting action of carbon steel, cast steel and alloy steel.</li> <li>• Variable land and progressive chipbreaker space, generating lower cutting force.</li> <li>• Straight edge line with reinforcement balances strength and cutting action.</li> </ul>		
TS	<ul style="list-style-type: none"> <li>• TS for semi-finishing of general steel and alloy steel.</li> <li>• Big rake angle lower cutting force.</li> <li>• Variable groove depth design, with super chip removal.</li> </ul>		

	80°Rhombic	55°Rhombic	90°Square	60°Regular Triangle	35°Rhombic	80°Trigon
						
	CNMG-GM P035	DNMG-GM P040	SNMG-GM P043	TNMG-GM P048	VNMG-GM P052	WNMG-GM P054
						
	CNMG <sub>R/L</sub> -SV P035	DNMG <sub>R/L</sub> -SV P040	SNMG <sub>R/L</sub> -SV P044	TNMG <sub>R/L</sub> -SV P048		WNMG <sub>R/L</sub> -SV P054
						
	CNMG-QR P037	DNMG-QR P042	SNMG-QR P046	TNMG-QR P049		WNMG-QR P056
						
	CNMM-QH P038		SNMM-QH P046			
						
		DNMG <sub>R/L</sub> -TS P041		TNMG <sub>R/L</sub> -TS P048		

# Overview of Turning Inserts

## Turning Inserts (Negative)

Chip Breaker	Features	Application Range	Cross Section Chip Breaker
TP	<ul style="list-style-type: none"> <li>• TP for semi-finishing of general steel, alloy steel and cast iron.</li> <li>• Dual rake angle and big cutting edge width design to promote its strength.</li> <li>• Overall pattern design, stable and reliable installation.</li> <li>• Arrow chip breaker improves chipbreaking performance during big cutting depth.</li> </ul>		
SF	<ul style="list-style-type: none"> <li>• SF for finishing of stainless steel.</li> <li>• Sharp edge due to results in low cutting forces particularly for thin wall structures and extended shafts.</li> </ul>		
YF	<ul style="list-style-type: none"> <li>• YF for finishing of stainless steel.</li> <li>• Inclination angle design is used to reduce cutting resistance and ensure good chip control.</li> </ul>		
SM	<ul style="list-style-type: none"> <li>• SM for medium cutting of stainless steel and mild steel.</li> <li>• Sharp cutting edge.</li> </ul>		
LM	<ul style="list-style-type: none"> <li>• LM for semi-finishing of stainless steel and high temperature alloy.</li> <li>• Variable rake angle and cutting edge width to ensure its sharpness and strength.</li> <li>• Heart-shaped chip breaker with good chip breaking.</li> </ul>		
LR	<ul style="list-style-type: none"> <li>• LR for stainless steel of roughing.</li> <li>• Small rake angle and big cutting edge width with strong corner.</li> <li>• Big chip breaker width and shallow.</li> <li>• Large chip breaker width and shallow chip breaker depth to ensure good chip removal.</li> </ul>		











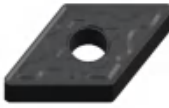















	80°Rhombic	55°Rhombic	90°Square	60°Regular Triangle	35°Rhombic	80°Trigon
						
	CNMG-TP P036	DNMG-TP P041	SNMG-TP P044	TNMG-TP P048	VNMG-TP P052	WNMG-TP P055
						
	CNMG-SF P034	DNMG-SF P039	SNMG-SF P043	TNMG-SF P047	VNMG-SF P051	WNMG-SF P053
						
	CNMG-YF P034	DNMG-YF P039	SNMG-YF P043	TNMG-YF P047	VNMG-YF P051	WNMG-YF P053
						
	CNMG-SM P036	DNMG-SM P040	SNMG-SM P044	TNMG-SM P048	VNMG-SM P052	WNMG-SM P055
						
	CNMG-LM P036	DNMG-LM P041	SNMG-LM P045	TNMG-LM P049	VNMG-LM P052	WNMG-LM P056
						
	CNMG-LR P037	DNMG-LR P042	SNMG-LR P045	TNMG-LR P049		WNMG-LR P056

# Overview of Turning Inserts

## Turning Inserts (Negative)

Chip Breaker	Features	Application Range	Cross Section Chip Breaker
<p><b>WMV</b> (Wiper)</p>	<ul style="list-style-type: none"> <li>• WMV for semi-finishing of general steel, alloy steel and cast iron.</li> <li>• Large chip breaker with low chip removal resistance.</li> <li>• Excellent sharp cutting edge and strength.</li> <li>• Good surface quality.</li> </ul>		
<p><b>MK</b></p>	<ul style="list-style-type: none"> <li>• MK for finishing of cast iron.</li> <li>• The cutting edge combines sharpness and strength, with low chip removal resistance.</li> </ul>		
<p><b>UK</b></p>	<ul style="list-style-type: none"> <li>• UK for machining cast iron.</li> <li>• Good performance after medium cutting for general conditions.</li> </ul>		
<p><b>HK</b></p>	<ul style="list-style-type: none"> <li>• HK for cast iron heavy cutting.</li> <li>• Strong cutting edge, big chip pocket, good at big cutting depth and width.</li> </ul>		
<p><b>Flat</b></p>	<ul style="list-style-type: none"> <li>• Flat-top for cast iron used.</li> <li>• Stable placement.</li> <li>• Strong edge design for intermittent cutting conditions.</li> </ul>		





















	80°Rhombic	55°Rhombic	90°Square	60°Regular Triangle	35°Rhombic	80°Trigon
	 <b>Wiper</b>	 <b>Wiper</b>		 <b>Wiper</b>		 <b>Wiper</b>
	CNMG-WMV P036	DNMX-WMV P041		TNMX-WMV P049		WNMG-WMV P055
						
	CNMG-MK P037	DNMG-MK P042	SNMG-MK P045	TNMG-MK P049	VNMG-MK P052	WNMG-MK P055
						
	CNMG-UK P037	DNMG-UK P042	SNMG-UK P045	TNMG-UK P049	VNMG-UK P052	WNMG-UK P056
						
	CNMG-HK P038	DNMG-HK P042	SNMG-HK P046	TNMG-HK P050	VNMG-HK P052	WNMG-HK P056
						
	CNMA P038	DNMA P042	SNMA P046	TNMA P050		WNMA P056

# Overview of Turning Inserts

## Turning Inserts (Negative)

Chip Breaker	Features	Application Range	Cross Section Chip Breaker
EL	<ul style="list-style-type: none"> <li>• EL for finishing to semi-finishing of high temperature alloy and titanium alloy.</li> <li>• Suitable for processing long overhanging and thin-walled workpieces.</li> <li>• Low cutting force to avoid vibration.</li> </ul>		
EM	<ul style="list-style-type: none"> <li>• EM for semi-finishing to roughing of high-temperature alloy.</li> <li>• High cutting edge strength, suitable for deep cutting processing.</li> </ul>		
SML	<ul style="list-style-type: none"> <li>• SML for finishing to semi-finishing of stainless steel and high temperature alloy.</li> <li>• Inclination angle design reduces cutting resistance and ensures good chip control.</li> </ul>		
SMM	<ul style="list-style-type: none"> <li>• SMM for semi-finishing to roughing of stainless steel and high-temperature alloy.</li> <li>• Unique chip-breaker design to meet different cutting depth and feed processing, ensuring processing stability.</li> </ul>		





	80°Rhombic	55°Rhombic	90°Square	60°Regular Triangle	35°Rhombic	80°Trigon
						
	CNMG-EL P034	DNMG-EL P039			VNMG-EL P051	WNMG-EL P053
						
	CNMG-EM P036	DNMG-EM P041	SNMG-EM P045	TNMG-EM P049	VNMG-EM P052	WNMG-EM P055
						
	CNMG-SML P035	DNMG-SML P040			VNMG-SML P051	WNMG-SML P053
						
	CNMG-SMM P036	DNMG-SMM P041	SNMG-SMM P045		VNMG-SMM P052	WNMG-SMM P055

# Overview of Turning Inserts

## Turning Inserts (Positive)

5° Clearance Angle

Chip Breaker	Features	Application Range	Cross Section Chip Breaker
MM	<ul style="list-style-type: none"> <li>• MM for semi-finishing and finishing of general steel, alloy steel and stainless steel.</li> <li>• Sharp cutting edge, enables high surface quality.</li> </ul>		
SPL	<ul style="list-style-type: none"> <li>• SPL for light cutting of general steel and alloy steel;</li> <li>• Wide range of chip-breaking and versatility.</li> </ul>		
GP	<ul style="list-style-type: none"> <li>• GP for light cutting of general steel, alloy steel, stainless steel and cast iron.</li> <li>• The combination of flat edge and double rake ensures a strong point degree and cutting sharpness.</li> </ul>		
TP	<ul style="list-style-type: none"> <li>• TP for light cutting of general steel, alloy steel and cast iron.</li> <li>• Dual rake angle and big cutting edge width design to promote its strength.</li> <li>• Overall pattern design, stable and reliable installation.</li> <li>• Arrow chip breaker improves chip breaking performance during big cutting depth.</li> </ul>		
KM	<ul style="list-style-type: none"> <li>• KM for semi-finishing and roughing of general steel, alloy steel and cast iron.</li> <li>• Variable land design, combine sharpness with fracture resistance.</li> </ul>		

	80°Rhombic	55°Rhombic	90°Square	60°Regular Triangle	35°Rhombic	80°Trigon
						
					VBMT-MM P065	
						
					VBMT-SPL P065	
						
					VBMT-GP P065	
						
					VBMT-TP P065	
						
					VBMT-KM P065	

# Overview of Turning Inserts

## Turning Inserts (Positive)

7° Clearance Angle

Chip Breaker	Features	Application Range	Cross Section Chip Breaker
MM	<ul style="list-style-type: none"> <li>• MM for light cutting of general steel, alloy steel and stainless steel.</li> <li>• Sharp cutting edge, enables high surface quality.</li> </ul>		
SPL	<ul style="list-style-type: none"> <li>• SPL for light cutting of general steel and alloy steel;</li> <li>• Wide range of chip-breaking and versatility.</li> </ul>		
GP	<ul style="list-style-type: none"> <li>• GP for light cutting of general steel, alloy steel, stainless steel and cast iron.</li> <li>• The combination of flat edge and double rake ensures a strong point degree and cutting sharpness.</li> </ul>		
TP	<ul style="list-style-type: none"> <li>• TP for light cutting of general steel, alloy steel and cast iron.</li> <li>• Dual rake angle and big cutting edge width design to promote its strength.</li> <li>• Overall pattern design, stable and reliable installation.</li> <li>• Arrow chip breaker improves chip breaking performance during big cutting depth.</li> </ul>		

	80°Rhombic	55°Rhombic	90°Square	60°Regular Triangle	35°Rhombic	80°Trigon
						
	CCMT-MM P057	DCMT-MM P059	SCMT-MM P061	TCMT-MM P062	VCMT-MM P066	
						
	CCMT-SPL P057	DCMT-SPL P059		TCMT-SPL P062	VCMT-SPL P066	
						
	CCMT-GP CCGT-GP P057	DCMT-GP DCGT-GP P059	SCMT-GP P061	TCMT-GP TCGT-GP P062	VCMT-GP VCGT-GP P066	WCMT-GP P067
						
	CCMT-TP P057	DCMT-TP P059	SCMT-TP P061	TCMT-TP P062		







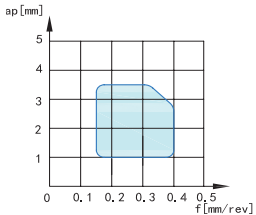
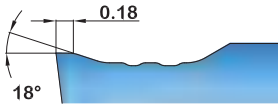
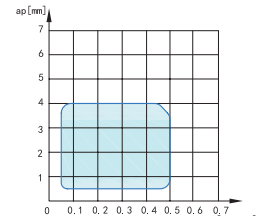
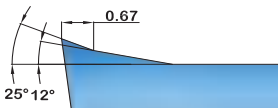

# Overview of Turning Inserts

Turning Inserts (Positive)

7° Clearance Angle

Chip Breaker	Features	Application Range	Cross Section Chip Breaker
<p><b>KM</b></p>	<ul style="list-style-type: none"> <li>• KM for semi-finishing and roughing of general steel, alloy steel and cast iron.</li> <li>• Variable land design, combine sharpness with fracture resistance.</li> </ul>	 <p>The graph shows the application range for the KM insert. The vertical axis is labeled 'ap [mm]' and ranges from 0 to 5. The horizontal axis is labeled 'f [mm/rev]' and ranges from 0 to 0.5. A shaded blue region indicates the recommended operating range, which is roughly between f = 0.15 and 0.45 mm/rev and ap = 1.5 and 4 mm.</p>	 <p>The cross-section diagram shows the chip breaker geometry for the KM insert. It features a 18° angle on the left side and a chip breaker height of 0.18 mm.</p>
<p><b>AL</b></p>	<ul style="list-style-type: none"> <li>• AL for aluminum alloy cutting.</li> <li>• Large rake angle, cutting edge sharpness.</li> </ul>	 <p>The graph shows the application range for the AL insert. The vertical axis is labeled 'ap [mm]' and ranges from 0 to 7. The horizontal axis is labeled 'f [mm/rev]' and ranges from 0 to 0.7. A shaded blue region indicates the recommended operating range, which is roughly between f = 0.1 and 0.5 mm/rev and ap = 1 and 4 mm.</p>	 <p>The cross-section diagram shows the chip breaker geometry for the AL insert. It features a 25° 12' angle on the left side and a chip breaker height of 0.67 mm.</p>







	80°Rhombic	55°Rhombic	90°Square	60°Regular Triangle	35°Rhombic	80°Trigon
						
	CCMT-KM	DCMT-KM	SCMT-KM	TCMT-KM	VCMT-KM	
	P058	P059	P061	P062	P066	
						
	CCGX-AL	DCGX-AL	SCGX-AL	TCGX-AL	VCGX-AL	
	P058	P060	P061	P063	P066	

# Overview of Turning Inserts

## Turning Inserts (Positive)

11° Clearance Angle

Chip Breaker	Features	Application Range	Cross Section Chip Breaker
MM	<ul style="list-style-type: none"> <li>• MM for light cutting of general steel, alloy steel and stainless steel.</li> <li>• Sharp cutting edge, enables high surface quality.</li> </ul>		
SPL	<ul style="list-style-type: none"> <li>• SPL for light cutting of general steel and alloy steel;</li> <li>• Wide range of chip-breaking and versatility.</li> </ul>		
GP	<ul style="list-style-type: none"> <li>• GP for light cutting of general steel, alloy steel, stainless steel and cast iron.</li> <li>• The combination of flat edge and double rake ensures a strong point degree and cutting sharpness.</li> </ul>		
TP	<ul style="list-style-type: none"> <li>• TP for light cutting of general steel, alloy steel and cast iron.</li> <li>• Dual rake angle and big cutting edge width design to promote its strength.</li> <li>• Overall pattern design, stable and reliable installation.</li> <li>• Arrow chip breaker improves chip breaking performance during big cutting depth.</li> </ul>		









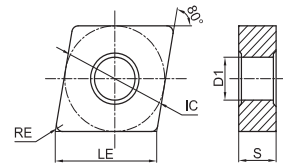











	80°Rhombic	55°Rhombic	90°Square	60°Regular Triangle	35°Rhombic	80°Trigon
						
				TPMT-MM P064		
						
				TPMT-SPL P064		
						
	CPGT-GP P058			TPGT-GP P064		
						
				TPMT-TP P064		

Turning Insert (Negative)

**CN** □ □

Rhombic 80° with Hole



Ordering Code	Dimension (mm)				Coated Carbides																Carbides	Cermet														
	LE	IC	S	D1	RE	GPT6110	GPT6120	GPT6130	GP1105	GP1115	GP1120	GP1225	GP1130	GP1135	GM1115	GM1125	GM1230	GM3215	GM3220	GM3225	GK1115	GK1120	GK1125	GST7115	GST7120	GST7130	GS3115	GNT7120	GN9110	GN9120	GN9130	GP31TM	GP91TM	GP92TM		
 CNMG090304-QF	9.7	9.525	3.18	3.81	0.4					○	○																									
 CNMG120404-QF	12.9	12.7	4.76	5.16	0.4	●	●	●	●	●	●	●									●														○	
 CNMG120408-QF	12.9	12.7	4.76	5.16	0.8	●	●	●	●	○	●		○																					○	○	
 CNMG120404-TF	12.9	12.7	4.76	5.16	0.4																													○	○	
 CNMG120408-TF	12.9	12.7	4.76	5.16	0.8																													○	○	
 CNMG090308-GF	9.7	9.525	3.18	3.81	0.8					○																										
 CNMG120404-GF	12.9	12.7	4.76	5.16	0.4					●	○																									
 CNMG120408-GF	12.9	12.7	4.76	5.16	0.8					○	●																									
 CNMG120412-GF	12.9	12.7	4.76	5.16	1.2					●																										
 CNMG120404-SF	12.9	12.7	4.76	5.16	0.4															●								●								
 CNMG120408-SF	12.9	12.7	4.76	5.16	0.8														○									●								
 CNMG120404-YF	12.9	12.7	4.76	5.16	0.4															●	●															
 CNMG120408-YF	12.9	12.7	4.76	5.16	0.8															●	●															
 CNMG120404-SPL	12.9	12.7	4.76	5.16	0.4																													●		
 CNMG120404-EL	12.9	12.7	4.76	5.16	0.4																				●	●										
 CNMG120408-EL	12.9	12.7	4.76	5.16	0.8																				●	●	●									
 CNMG120412-EL	12.9	12.7	4.76	5.16	1.2																				●	●										
 CNMG160608-EL	16.1	15.875	6.35	6.35	0.8																				●	●										
 CNMG160612-EL	16.1	15.875	6.35	6.35	1.2																				●	●										
 CNMG190608-EL	19.3	19.05	6.35	7.94	0.8																						●									
 CNMG190612-EL	19.3	19.05	6.35	7.94	1.2																						●									





● Stock ○ Available Upon Order

Turning Insert (Negative)

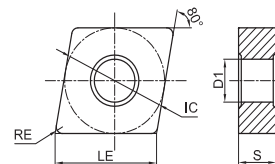
CN □ □

Rhombic 80° with Hole



Ordering Code	Dimension (mm)					Coated Carbides																Carbides	Cermet																
	LE	IC	S	D1	RE	GPT6110	GPT6120	GPT6130	GP1105	GP1115	GP1120	GP1225	GP1130	GP1135	GM1115	GM1125	GM1230	GM3215	GM3220	GM3225	GK1115	GK1120	GK1125	GST7115	GST7120	GST7130	GS3115	GNT7120	GN9110	GN9120	GN9130	GP31TM	GP91TM	GP92TM					
 CNMG120404-SML 12.9 12.7 4.76 5.16 0.4																									●	●													
CNMG120408-SML 12.9 12.7 4.76 5.16 0.8																									●	●	●												
CNMG120412-SML 12.9 12.7 4.76 5.16 1.2																									●	●													
CNMG090304-QM 9.7 9.525 3.18 3.81 0.4 ○										○		●	○																										
CNMG090308-QM 9.7 9.525 3.18 3.81 0.8										●	○	○																											
CNMG120404-QM 12.9 12.7 4.76 5.16 0.4						●	●	●	●	●	●	●	●	●	○						●														●	●			
CNMG120408-QM 12.9 12.7 4.76 5.16 0.8						●	●	●	●	●	●	●	●	●							●															●			
 CNMG120412-QM 12.9 12.7 4.76 5.16 1.2						●	●	●	●	●	●	●	●	●								●																	
CNMG120416-QM 12.9 12.7 4.76 5.16 1.6										●	○	●	●																										
CNMG160608-QM 16.1 15.875 6.35 6.35 0.8						●	●	●	●	●	●	●	○																										
CNMG160612-QM 16.1 15.875 6.35 6.35 1.2						●	●	●	●	○	●	○																											
CNMG190608-QM 19.3 19.05 6.35 7.94 0.8 ○						○	○	○		●	○	●										●																	
CNMG190612-QM 19.3 19.05 6.35 7.94 1.2										●	○	●	○																										
CNMG190616-QM 19.3 19.05 6.35 7.94 1.6 ○						○				●	●																												
CNMG120404-GM 12.9 12.7 4.76 5.16 0.4										●	●																												
CNMG120408-GM 12.9 12.7 4.76 5.16 0.8										●	●																												
CNMG120412-GM 12.9 12.7 4.76 5.16 1.2										●	●																												
CNMG120416-GM 12.9 12.7 4.76 5.16 1.6											○	●																											
 CNMG160608-GM 16.1 15.875 6.35 6.35 0.8										●	●																												
CNMG160612-GM 16.1 15.875 6.35 6.35 1.2										●	●																												
CNMG160616-GM 16.1 15.875 6.35 6.35 1.6											○	●																											
CNMG190608-GM 19.3 19.05 6.35 7.94 0.8													○																										
CNMG190612-GM 19.3 19.05 6.35 7.94 1.2											○	●																											
CNMG190616-GM 19.3 19.05 6.35 7.94 1.6											●	●																											
 CNMG120408R-SV 12.9 12.7 4.76 5.16 0.8												●																											
CNMG120408L-SV 12.9 12.7 4.76 5.16 0.8													●																										

● Stock ○ Available Upon Order

Turning Insert (Negative)

CN□□

Rhombic 80° with Hole

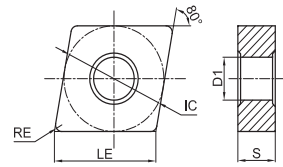

Ordering Code	Dimension (mm)					Coated Carbides																		Carbides	Cermet												
	LE	IC	S	D1	RE	GPT6110	GPT6120	GPT6130	GP1105	GP1115	GP1120	GP1225	GP1130	GP1135	GM1115	GM1125	GM1230	GM3215	GM3220	GM3225	GK1115	GK1120	GK1125	GST7115	GST7120	GST7130	GS3115	GNT7120	GN9110	GN9120	GN9130	GP31TM	GP91TM	GP92TM			
CNMG090304-SM	9.7	9.525	3.18	3.81	0.4											○	○		●																		
CNMG090308-SM	9.7	9.525	3.18	3.81	0.8											●	○		●																		
CNMG120404-SM	12.9	12.7	4.76	5.16	0.4											●	●	●	○	●	●					○											
CNMG120408-SM	12.9	12.7	4.76	5.16	0.8											●	●	●	●	●	●					●											
CNMG120412-SM	12.9	12.7	4.76	5.16	1.2											●	●		●	●					●												
CNMG120416-SM	12.9	12.7	4.76	5.16	1.6																				●												
CNMG160608-SM	16.1	15.875	6.35	6.35	0.8											●	●			●																	
CNMG160612-SM	16.1	15.875	6.35	6.35	1.2											○	○			●																	
CNMG160616-SM	16.1	15.875	6.35	6.35	1.6											●	○			●																	
CNMG190608-SM	19.3	19.05	6.35	7.94	0.8																●																
CNMG190612-SM	19.3	19.05	6.35	7.94	1.2											○	●			●																	
CNMG190616-SM	19.3	19.05	6.35	7.94	1.6											○	○	○	●																		
CNMG120404-TP	12.9	12.7	4.76	5.16	0.4																												●	●			
CNMG120408-TP	12.9	12.7	4.76	5.16	0.8																											○	●				
CNMG120404-LM	12.9	12.7	4.76	5.16	0.4											●	●	●	●	●																	
CNMG120408-LM	12.9	12.7	4.76	5.16	0.8											●	●	●	●	●																	
CNMG120412-LM	12.9	12.7	4.76	5.16	1.2											●	●	○	●	●	●																
CNMG120404-EM	12.9	12.7	4.76	5.16	0.4																			●	●	●											
CNMG120408-EM	12.9	12.7	4.76	5.16	0.8																			●	●	●											
CNMG120412-EM	12.9	12.7	4.76	5.16	1.2																			●	●	●											
CNMG160608-EM	16.1	15.875	6.35	6.35	0.8																			●	●	●											
CNMG160612-EM	16.1	15.875	6.35	6.35	1.2																			●	●	●											
CNMG120404-SMM	12.9	12.7	4.76	5.16	0.4																			●													
CNMG120408-SMM	12.9	12.7	4.76	5.16	0.8																				●												
CNMG120412-SMM	12.9	12.7	4.76	5.16	1.2																				●												
CNMG120408-WMV	12.9	12.7	4.76	5.16	0.8																		●	○													
CNMG120412-WMV	12.9	12.7	4.76	5.16	1.2											○							●														
Wiper																																					

● Stock ○ Available Upon Order

### Turning Insert (Negative)

# CN

Rhombic 80° with Hole

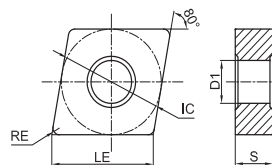

Ordering Code	Dimension (mm)					Coated Carbides														Carbides	Cermet													
	LE	IC	S	D1	RE	GPT6110	GPT6120	GPT6130	GP1105	GP1115	GP1120	GP1225	GP1130	GP1135	GM1115	GM1125	GM1230	GM3215	GM3220	GM3225	GK1115	GK1120	GK1125	GST7115	GST7120	GST7130	GS3115	GNT7120	GN9110	GN9120	GN9130	GP31TM	GP92TM	
	CNMG120404-MK	12.9	12.7	4.76	5.16	0.4																												
	CNMG120408-MK	12.9	12.7	4.76	5.16	0.8																	●	●										
	CNMG120412-MK	12.9	12.7	4.76	5.16	1.2																	●	●										
	CNMG120404-UK	12.9	12.7	4.76	5.16	0.4																												
	CNMG120408-UK	12.9	12.7	4.76	5.16	0.8																												
	CNMG120412-UK	12.9	12.7	4.76	5.16	1.2																												
	CNMG120416-UK	12.9	12.7	4.76	5.16	1.6																												
	CNMG160608-UK	16.1	15.875	6.35	6.35	0.8																												
	CNMG160612-UK	16.1	15.875	6.35	6.35	1.2																												
	CNMG160616-UK	16.1	15.875	6.35	6.35	1.6																												
	CNMG190612-UK	19.3	19.05	6.35	7.94	1.2																												
	CNMG190616-UK	19.3	19.05	6.35	7.94	1.6																												
	CNMG120408-LR	12.9	12.7	4.76	5.16	0.8																												
	CNMG120412-LR	12.9	12.7	4.76	5.16	1.2																												
	CNMG120416-LR	12.9	12.7	4.76	5.16	1.6																												
	CNMG160608-LR	16.1	15.875	6.35	6.35	0.8																												
	CNMG160612-LR	16.1	15.875	6.35	6.35	1.2																												
	CNMG190612-LR	19.3	19.05	6.35	7.94	1.2																												
	CNMG190616-LR	19.3	19.05	6.35	7.94	1.6																												
	CNMG120408-QR	12.9	12.7	4.76	5.16	0.8	●	●	●	●	●	●	●	●	●	●	●	●	●	●	●	●	●	●	●	●	●	●	●	●	●	●	●	●
	CNMG120412-QR	12.9	12.7	4.76	5.16	1.2	●	●	●	○	●	●	●	●	●	●	●	●	●	●	●	●	●	●	●	●	●	●	●	●	●	●	●	●
CNMG120416-QR	12.9	12.7	4.76	5.16	1.6	●	○	●	●	○	●	●	●	●	●	●	●	●	●	●	●	●	●	●	●	●	●	●	●	●	●	●	●	
CNMG160608-QR	16.1	15.875	6.35	6.35	0.8																													
	CNMG160612-QR	16.1	15.875	6.35	6.35	1.2	●	●	●	●	●	●	●	●	●	●	●	●	●	●	●	●	●	●	●	●	●	●	●	●	●	●	●	
	CNMG160616-QR	16.1	15.875	6.35	6.35	1.6	●	●	●	○	●	●	●	●	●	●	●	●	●	●	●	●	●	●	●	●	●	●	●	●	●	●	●	
	CNMG190608-QR	19.3	19.05	6.35	7.94	0.8	○	○	○																									
	CNMG190612-QR	19.3	19.05	6.35	7.94	1.2				○	○																							
	CNMG190616-QR	19.3	19.05	6.35	7.94	1.6	○	○	○	●	○																							
	CNMG190624-QR	19.3	19.05	6.35	7.94	2.4	○	○	○	●																								
	CNMG250924-QR	25.8	25.4	9.52	9.12	2.4	○	○	○																									

●Stock ○Available Upon Order

Turning Insert (Negative)

**CN** □ □

Rhombic 80° with Hole

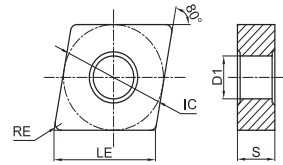

Ordering Code	Dimension (mm)					Coated Carbides														Carbides	Cermet															
	LE	IC	S	D1	RE	GPT6110	GPT6120	GPT6130	GP1105	GP1115	GP1120	GP1225	GP1130	GP1135	GM1115	GM1125	GM1230	GM3215	GM3220	GM3225	GK1115	GK1120	GK1125	GST7115	GST7120	GST7130	GS3115	GNT7120	GN9110	GN9120	GN9130	GP31TM	GP91TM	GP92TM		
CNMG120408-HK	12.9	12.7	4.76	5.16	0.8					●	●											●	●	●												
CNMG120412-HK	12.9	12.7	4.76	5.16	1.2																	●	●	●												
CNMG120416-HK	12.9	12.7	4.76	5.16	1.6																	●	●	●												
CNMG160612-HK	16.1	15.875	6.35	6.35	1.2					●													●	●	●											
CNMG160616-HK	16.1	15.875	6.35	6.35	1.6																		●	●	●											
CNMG190612-HK	19.3	19.05	6.35	7.94	1.2																		●	●	○											
CNMG190616-HK	19.3	19.05	6.35	7.94	1.6																		●	●												
CNMM190616-QH	19.3	19.05	6.35	7.94	1.6				○		●	●																								
CNMM190624-QH	19.3	19.05	6.35	7.94	2.4	○	○	○			●	●																								
CNMM250924-QH	25.8	25.4	9.52	9.12	2.4	○	○	○	●	●	●	○																								
CNMA120404	12.9	12.7	4.76	5.16	0.4																		●	●												
CNMA120408	12.9	12.7	4.76	5.16	0.8																		●	●	●											
CNMA120412	12.9	12.7	4.76	5.16	1.2																		●	●	●											
CNMA120416	12.9	12.7	4.76	5.16	1.6																		●	●	○											
CNMA160612	16.1	15.875	6.35	6.35	1.2																		●	●	●											
CNMA160616	16.1	15.875	6.35	6.35	1.6																		●	●	○											
CNMA160620	16.1	15.875	6.35	6.35	2.0																		●													
CNMA190612	19.3	19.05	6.35	7.94	1.2																		●	●												
CNMA190616	19.3	19.05	6.35	7.94	1.6																		●	●	●											
CNMA190624	19.3	19.05	6.35	7.94	2.4																		●	○	●											

● Stock ○ Available Upon Order



Turning Insert (Negative)

**DN** □ □

Rhombic 55° with Hole

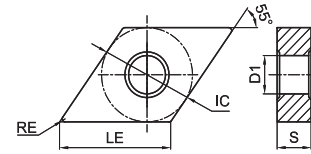

Ordering Code	Dimension (mm)					Coated Carbides																Carbides	Cermet													
	LE	IC	S	D1	RE	GPT6110	GPT6120	GPT6130	GP1105	GP1115	GP1120	GP1225	GP1130	GP1135	GM1115	GM1125	GM1230	GM3215	GM3220	GM3225	GK1115	GK1120	GK1125	GST7115	GST7120	GST7130	GS3115	GNT7120	GN9110	GN9120	GN9130	GP31TM	GP91TM	GP92TM		
DNMG110404-QF	11.6	9.525	4.76	3.81	0.4	●	●	●	●	○																										
DNMG110408-QF	11.6	9.525	4.76	3.81	0.8	●	●	●	●	●	●	○																								
DNMG150404-QF	15.5	12.7	4.76	5.16	0.4	●	●	●	●	○																									●	○
DNMG150408-QF	15.5	12.7	4.76	5.16	0.8	●	○	●	●	○																									○	○
DNMG150604-QF	15.5	12.7	6.35	5.16	0.4	○	●	○	●	●																										○
DNMG150608-QF	15.5	12.7	6.35	5.16	0.8			○	●	●																										
DNMG150404-TF	15.5	12.7	4.76	5.16	0.4																														○	○
DNMG150408-TF	15.5	12.7	4.76	5.16	0.8																														○	○
DNMG110404-GF	11.6	9.525	4.76	3.81	0.4					○																										
DNMG110408-GF	11.6	9.525	4.76	3.81	0.8					○	●																									
DNMG150404-GF	15.5	12.7	4.76	5.16	0.4					○																										
DNMG150408-GF	15.5	12.7	4.76	5.16	0.8					●	●																									
DNMG150608-GF	15.5	12.7	6.35	5.16	0.8					○																										
DNMG110404-SF	11.6	9.525	4.76	3.81	0.4													○								○										
DNMG110408-SF	11.6	9.525	4.76	3.81	0.8													○								○										
DNMG150404-SF	15.5	12.7	4.76	5.16	0.4													○									●									
DNMG150408-SF	15.5	12.7	4.76	5.16	0.8													○									●									
DNMG150604-SF	15.5	12.7	6.35	5.16	0.4													○									●									
DNMG150608-SF	15.5	12.7	6.35	5.16	0.8													○									●									
DNMG150404-YF	15.5	12.7	4.76	5.16	0.4													●																		
DNMG150408-YF	15.5	12.7	4.76	5.16	0.8													●																		
DNMG150604-YF	15.5	12.7	6.35	5.16	0.4													●	●																	
DNMG150608-YF	15.5	12.7	6.35	5.16	0.8													●																		
DNMG150404-SPL	15.5	12.7	4.76	5.16	0.4																															●
DNMG150408-SPL	15.5	12.7	4.76	5.16	0.8																															●
DNMG150404-EL	15.5	12.7	4.76	5.16	0.4																					●										
DNMG150408-EL	15.5	12.7	4.76	5.16	0.8																					●	●									
DNMG150412-EL	15.5	12.7	4.76	5.16	1.2																					●	●									
DNMG150604-EL	15.5	12.7	6.35	5.16	0.4																					●										
DNMG150608-EL	15.5	12.7	6.35	5.16	0.8																					●	●									
DNMG150612-EL	15.5	12.7	6.35	5.16	1.2																					●	●									

● Stock ○ Available Upon Order



Turning Insert (Negative)

**DN** □ □

Rhombic 55° with Hole

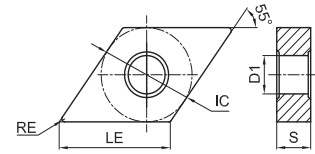

Ordering Code	Dimension (mm)					Coated Carbides													Carbides	Cermet																	
	LE	IC	S	D1	RE	GPT6110	GPT6120	GPT6130	GP1105	GP1115	GP1120	GP1225	GP1130	GP1135	GM1115	GM1125	GM1230	GM3215	GM3220	GM3225	GK1115	GK1120	GK1125	GST7115	GST7120	GST7130	GS3115	GNT7120	GN9110	GN9120	GN9130	GP31TM	GP91TM	GP92TM			
 DNMG150404-TP	15.5	12.7	4.76	5.16	0.4																														●	○	
DNMG150408-TP	15.5	12.7	4.76	5.16	0.8																														●	○	
DNMG150604-TP	15.5	12.7	6.35	5.16	0.4																														○	○	
DNMG150608-TP	15.5	12.7	6.35	5.16	0.8																														●	○	
DNMG150404R -TS	15.5	12.7	6.35	5.16	0.4																														●	●	
DNMG150404L -TS	15.5	12.7	6.35	5.16	0.4																														●	○	
DNMG150408R -TS	15.5	12.7	6.35	5.16	0.8																														●	○	
DNMG150408L -TS	15.5	12.7	6.35	5.16	0.8																														●	●	
DNMG110404-LM	11.6	9.525	4.76	3.81	0.4											○	○	○	○	●	●																
DNMG110408-LM	11.6	9.525	4.76	3.81	0.8											●	○	●	●	●																	
DNMG150404-LM	15.5	12.7	4.76	5.16	0.4											○	○	○	○	●	●																
DNMG150408-LM	15.5	12.7	4.76	5.16	0.8											○	●	○	●	●	●																
DNMG150412-LM	15.5	12.7	4.76	5.16	1.2											○		○	○																		
DNMG150604-LM	15.5	12.7	6.35	5.16	0.4											○		●	○	●																	
DNMG150608-LM	15.5	12.7	6.35	5.16	0.8											○	○	○	○	●	●																
DNMG150612-LM	15.5	12.7	6.35	5.16	1.2											○		●	●	●																	
DNMG150408-EM	15.5	12.7	4.76	5.16	0.8																					●	●	●									
DNMG150412-EM	15.5	12.7	4.76	5.16	1.2																					●	●	●									
DNMG150608-EM	15.5	12.7	6.35	5.16	0.8																					●	●	●									
DNMG150612-EM	15.5	12.7	6.35	5.16	1.2																					●	●	●									
DNMG150408-SMM	15.5	12.7	4.76	5.16	0.8																					●											
DNMG150608-SMM	15.5	12.7	6.35	5.16	0.8																					●											
DNMX150408-WMV	15.5	12.7	4.76	5.16	0.8																					○											
DNMX150412-WMV	15.5	12.7	4.76	5.16	1.2																					●											
DNMX150608-WMV	15.5	12.7	6.35	5.16	0.8																					○											
<b>Wiper</b> DNMX150612-WMV	15.5	12.7	6.35	5.16	1.2																					○	●	●									

● Stock ○ Available Upon Order

Turning Insert (Negative)

**DN** □ □

Rhombic 55° with Hole

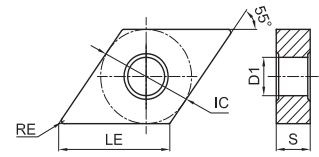

Ordering Code	Dimension (mm)					Coated Carbides														Carbides	Cermet															
	LE	IC	S	D1	RE	GPT6110	GPT6120	GPT6130	GPL105	GPL115	GPL120	GPL225	GPL130	GPL135	GM1115	GM1125	GM1230	GM3215	GM3220	GM3225	GK1115	GK1125	GK1125	GK1125	GST7115	GST7120	GST7130	GS3115	GNT7120	GN9110	GN9120	GN9130	GP31TM	GP91TM	GP92TM	
DNMG150404-MK	15.5	12.7	4.76	5.16	0.4																	●	●													
DNMG150408-MK	15.5	12.7	4.76	5.16	0.8																		●	●												
DNMG150412-MK	15.5	12.7	4.76	5.16	1.2																		●	●												
DNMG150604-MK	15.5	12.7	6.35	5.16	0.4																		●	●												
DNMG150608-MK	15.5	12.7	6.35	5.16	0.8																		●	●												
DNMG150612-MK	15.5	12.7	6.35	5.16	1.2																			●												
DNMG150404-UK	15.5	12.7	4.76	5.16	0.4																		●	●												
DNMG150408-UK	15.5	12.7	4.76	5.16	0.8																		●	●	●											
DNMG150412-UK	15.5	12.7	4.76	5.16	1.2																		●	○												
DNMG150604-UK	15.5	12.7	6.35	5.16	0.4																		●	○	●											
DNMG150608-UK	15.5	12.7	6.35	5.16	0.8																		●	●	●											
DNMG150612-UK	15.5	12.7	6.35	5.16	1.2																		●	○	○											
DNMG150616-UK	15.5	12.7	6.35	5.16	1.6																		●	●												
DNMG150408-LR	15.5	12.7	4.76	5.16	0.8																		●													
DNMG150412-LR	15.5	12.7	4.76	5.16	1.2																		●													
DNMG150608-LR	15.5	12.7	6.35	5.16	0.8										●								●													
DNMG150612-LR	15.5	12.7	6.35	5.16	1.2																			○												
DNMG150408-QR	15.5	12.7	4.76	5.16	0.8	○	●	○				○																								
DNMG150412-QR	15.5	12.7	4.76	5.16	1.2	○	●	○				○																								
DNMG150608-QR	15.5	12.7	6.35	5.16	0.8	●	●	●	○		●	●																								
DNMG150612-QR	15.5	12.7	6.35	5.16	1.2	●	○	●	●	●	●	●	●		○																					
DNMG150616-QR	15.5	12.7	6.35	5.16	1.6	○	●	○	●	●	●	●	●		○																					
DNMG150408-HK	15.5	12.7	4.76	5.16	0.8																		●	●	○											
DNMG150412-HK	15.5	12.7	4.76	5.16	1.2																		●	●	●											
DNMG150608-HK	15.5	12.7	6.35	5.16	0.8																		●	●	●											
DNMG150612-HK	15.5	12.7	6.35	5.16	1.2																		●	●	●											
DNMA150404	15.5	12.7	4.76	5.16	0.4																		●	●												
DNMA150408	15.5	12.7	4.76	5.16	0.8																		●	●	●											
DNMA150412	15.5	12.7	4.76	5.16	1.2																		●	○	○											
DNMA150416	15.5	12.7	4.76	5.16	1.6																		●	●												
DNMA150604	15.5	12.7	6.35	5.16	0.4																		○	●												
DNMA150608	15.5	12.7	6.35	5.16	0.8																		●	●	●											
DNMA150612	15.5	12.7	6.35	5.16	1.2																		●	●	●											





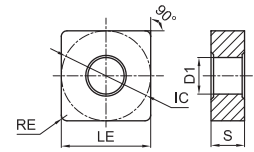

●Stock ○Available Upon Order

Turning Insert (Negative)

**SN**□□

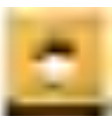
Square 90° with Hole



Ordering Code	Dimension (mm)					Coated Carbides																Carbides	Cermet													
	LE	IC	S	D1	RE	GPT6110	GPT6120	GPT6130	GP1105	GP1115	GP1120	GP1225	GP1130	GP1135	GM1115	GM1125	GM1230	GM3215	GM3220	GM3225	GK1115	GK1120	GK1125	GST7115	GST7120	GST7130	GS3115	GNT7120	GN9110	GN9120	GN9130	GP31TM	GP91TM	GP92TM		
	SNMG090304-QF	9.525	9.525	3.18	3.81	0.4																														○
	SNMG090308-QF	9.525	9.525	3.18	3.81	0.8																														○
	SNMG120404-QF	12.7	12.7	4.76	5.16	0.4	○	●	○	○	○																								○	
	SNMG120408-QF	12.7	12.7	4.76	5.16	0.8	●	●	●	●	○																									●
	SNMG120404-GF	12.7	12.7	4.76	5.16	0.4					○																									
	SNMG120408-GF	12.7	12.7	4.76	5.16	0.8					○																									
	SNMG120404-SF	12.7	12.7	4.76	5.16	0.4																													●	
	SNMG120408-SF	12.7	12.7	4.76	5.16	0.8																														●
	SNMG120404-YF	12.7	12.7	4.76	5.16	0.4																													● ●	
	SNMG120408-YF	12.7	12.7	4.76	5.16	0.8																														● ●
	SNMG090304-QM	9.525	9.525	3.18	3.81	0.4								○	○	○																				
	SNMG090308-QM	9.525	9.525	3.18	3.81	0.8								○	●	○																				
	SNMG120404-QM	12.7	12.7	4.76	5.16	0.4	○	○	●	○	○	●	●																							
	SNMG120408-QM	12.7	12.7	4.76	5.16	0.8	●	●	●	●	●	●	●	●	●																					
	SNMG120412-QM	12.7	12.7	4.76	5.16	1.2	●	○	○	○	●	●	●																							
	SNMG120416-QM	12.7	12.7	4.76	5.16	1.6	●	●	●			●	○																							
	SNMG150608-QM	15.875	15.875	6.35	6.35	0.8	○	●	○	○	○	○																								
	SNMG150612-QM	15.875	15.875	6.35	6.35	1.2	●	●	●	○	●	○																								
SNMG190612-QM	19.05	19.05	6.35	7.94	1.2	●		○	○	●																										
	SNMG090304-GM	9.525	9.525	3.18	3.81	0.4									○																					
	SNMG090308-GM	9.525	9.525	3.18	3.81	0.8									○																					
	SNMG120404-GM	12.7	12.7	4.76	5.16	0.4									●																					
	SNMG120408-GM	12.7	12.7	4.76	5.16	0.8									○	●																				
	SNMG120412-GM	12.7	12.7	4.76	5.16	1.2										●	●																			
	SNMG120416-GM	12.7	12.7	4.76	5.16	1.6											●																			
	SNMG150608-GM	15.875	15.875	6.35	6.35	0.8										●																				
	SNMG150612-GM	15.875	15.875	6.35	6.35	1.2											●																			
	SNMG190612-GM	19.05	19.05	6.35	7.94	1.2												●																		
	SNMG190616-GM	19.05	19.05	6.35	7.94	1.6										○																				

● Stock ○ Available Upon Order

Turning Insert (Negative)

**SN** □ □

Square 90° with Hole

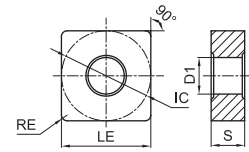

Ordering Code	Dimension (mm)					Coated Carbidés													Carbidés	Cermet																
	LE	IC	S	D1	RE	GPT6110	GPT6120	GPT6130	GP1105	GP1115	GP1120	GP1225	GP1130	GP1135	GM1115	GM1125	GM1230	GM3215	GM3220	GM3225	GK1115	GK1120	GK1125	GST7115	GST7120	GST7130	GS3115	GNT7120	GN9110	GN9120	GN9130	GP31TM	GP91TM	GP92TM		
	SNMG120404R-SV	12.7	12.7	4.76	5.16	0.4									●																				○	
	SNMG120408R-SV	12.7	12.7	4.76	5.16	0.8									●																				●	
	SNMG120408L-SV	12.7	12.7	4.76	5.16	0.8									●																				○	
	SNMG090304-SM	9.525	9.525	3.18	3.81	0.4										●	○	●																		
	SNMG120404-SM	12.7	12.7	4.76	5.16	0.4										●	●	●	●																	
	SNMG120408-SM	12.7	12.7	4.76	5.16	0.8									○	●	●	●	●	●							●						●			
	SNMG120412-SM	12.7	12.7	4.76	5.16	1.2										●	○	●	○																	
	SNMG120416-SM	12.7	12.7	4.76	5.16	1.6										●	○	○																		
	SNMG150608-SM	15.875	15.875	6.35	6.35	0.8												●	●	●								●								
	SNMG150612-SM	15.875	15.875	6.35	6.35	1.2													○																	
	SNMG150616-SM	15.875	15.875	6.35	6.35	1.6										●		●																		
	SNMG190612-SM	19.05	19.05	6.35	7.94	1.2											○	○	●																	
	SNMG190616-SM	19.05	19.05	6.35	7.94	1.6											●	○	●																	
	SNMG120404-TP	12.7	12.7	4.76	5.16	0.4																												○		
	SNMG120408-TP	12.7	12.7	4.76	5.16	0.8																												○		

● Stock ○ Available Upon Order



Turning Insert (Negative)

**SN** □ □  
Square 90° with Hole

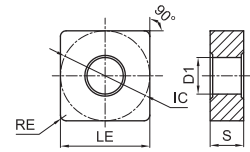

Ordering Code	Dimension (mm)					Coated Carbides																Carbides	Cermet															
	LE	IC	S	D1	RE	GPT6110	GPT6120	GPT6130	GP1105	GP1115	GP1120	GP1225	GP1130	GP1135	GM1115	GM1125	GM1230	GM3215	GM3220	GM3225	GK1115	GK1120	GK1125	GST7115	GST7120	GST7130	GS3115	GNT7120	GN9110	GN9120	GN9130	GP31TM	GP91TM	GP92TM				
SNMG120408-QR	12.7	12.7	4.76	5.16	0.8	○	○	○					●	●																								
SNMG120412-QR	12.7	12.7	4.76	5.16	1.2	○	○	○				○	●																									
SNMG120416-QR	12.7	12.7	4.76	5.16	1.6	○	●	○				○	●																									
SNMG150608-QR	15.875	15.875	6.35	6.35	0.8							○	○																									
SNMG150612-QR	15.875	15.875	6.35	6.35	1.2							●	○																									
SNMG150616-QR	15.875	15.875	6.35	6.35	1.6							○	○																									
SNMG150624-QR	15.875	15.875	6.35	6.35	2.4							●																										
SNMG190608-QR	19.05	19.05	6.35	7.94	0.8							○																										
SNMG190612-QR	19.05	19.05	6.35	7.94	1.2			○				●	●																									
SNMG190616-QR	19.05	19.05	6.35	7.94	1.6	○	○	○	●			●	●																									
SNMG190624-QR	19.05	19.05	6.35	7.94	2.4	○	○	○				○																										
SNMG250724-QR	25.4	25.4	7.94	9.21	2.4							○																										
SNMG250924-QR	25.4	25.4	9.52	9.21	2.4							○																										
SNMG120408-HK	12.7	12.7	4.76	5.16	0.8																	●	●	●														
SNMG120412-HK	12.7	12.7	4.76	5.16	1.2																	●	●	●														
SNMG120416-HK	12.7	12.7	4.76	5.16	1.6																	●	●	●														
SNMG150612-HK	15.875	15.875	6.35	6.35	1.2																	●	○	●														
SNMG150616-HK	15.875	15.875	6.35	6.35	1.6																	○	○															
SNMG190612-HK	19.05	19.05	6.35	7.94	1.2																	●	○	●														
SNMG190616-HK	19.05	19.05	6.35	7.94	1.6																	○	○	●														
SNMM150616-QH	15.875	15.875	6.35	7.94	1.6			○	●																													
SNMM190612-QH	19.05	19.05	6.35	7.94	1.2							○																										
SNMM190616-QH	19.05	19.05	6.35	7.94	1.6							●	○																									
SNMM190624-QH	19.05	19.05	6.35	7.94	2.4	○	○					●	○																									
SNMM250724-QH	25.4	25.4	7.94	9.12	2.4				●	●		●	●																									
SNMM250924-QH	25.4	25.4	9.52	9.12	2.4	○	○	○	●	○		●	●																									
SNMM250932-QH	25.4	25.4	9.52	9.12	3.2							○	○																									
SNMA090308	9.525	9.525	3.18	3.81	0.8																	●																
SNMA120404	12.7	12.7	4.76	5.16	0.4																	●	●															
SNMA120408	12.7	12.7	4.76	5.16	0.8																	●	●	●														
SNMA120412	12.7	12.7	4.76	5.16	1.2																	●	●	●														
SNMA120416	12.7	12.7	4.76	5.16	1.6																	●	○	●														
SNMA190612	19.05	19.05	6.35	7.94	1.2																	●	○	○														
SNMA190616	19.05	19.05	6.35	7.94	1.6																	●	○	○														
SNMA190632	19.05	19.05	6.35	7.94	3.2																	○																

● Stock ○ Available Upon Order



Turning Insert (Negative)

**TN** □ □

Triangle 60° with Hole

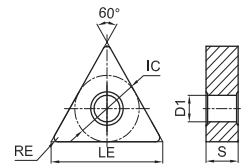

Ordering Code	Dimension (mm)					Coated Carbides														Carbides	Cermet														
	LE	IC	S	D1	RE	GPT6110	GPT6120	GPT6130	GP1105	GP1115	GP1120	GP1225	GP1130	GP1135	GM1115	GM1125	GM1230	GM3215	GM3220	GM3225	GK1115	GK1120	GK1125	GST7115	GST7120	GST7130	GS3115	GNT7120	GN9110	GN9120	GN9130	GP31TM	GP91TM	GP92TM	
	TNMG160404-QF	16.5	9.525	4.76	3.81	0.4	●	●	●	●	●	●	●	●																			●	●	
	TNMG160408-QF	16.5	9.525	4.76	3.81	0.8	●	●	●	●	●	○	●																					○	●
	TNMG220404-QF	22	12.7	4.76	5.16	0.4	○	○	○		●		○																						
	TNMG160404-TF	16.5	9.525	4.76	3.81	0.4																												○	○
	TNMG160408-TF	16.5	9.525	4.76	3.81	0.8																												○	○
	TNMG160404-GF	16.5	9.525	4.76	3.81	0.4															●	●													
	TNMG160408-GF	16.5	9.525	4.76	3.81	0.8															●	○													
	TNMG220404-GF	22	12.7	4.76	5.16	0.4															●														
	TNMG160404-SF	16.5	9.525	4.76	3.81	0.4														●	●					●									
	TNMG160408-SF	16.5	9.525	4.76	3.81	0.8														●						●									
	TNMG160404-YF	16.5	9.525	4.76	3.81	0.4														●	●														
	TNMG160408-YF	16.5	9.525	4.76	3.81	0.8														●	●														
	TNMG160404-SPL	16.5	9.525	4.76	3.81	0.4																												●	
	TNMG160408-SPL	16.5	9.525	4.76	3.81	0.8																												●	
	TNMG110304-QM	11	6.35	3.18	2.26	0.4														○	○														
	TNMG110308-QM	11	6.35	3.18	2.26	0.8															○	○													
	TNMG160404-QM	16.5	9.525	4.76	3.81	0.4	●	●	●	●	●	●	●	●	●	○					●	●												●	
	TNMG160408-QM	16.5	9.525	4.76	3.81	0.8	●	●	●	●	●	●	●	●	●	●	●					●												○	●
	TNMG160412-QM	16.5	9.525	4.76	3.81	1.2	●	●	●	●	●	○	●	●	●						●														
	TNMG220408-QM	22	12.7	4.76	5.16	0.8	○	○	○		●		●																						
	TNMG220412-QM	22	12.7	4.76	5.16	1.2	○	○	○		●		●																						
TNMG220416-QM	22	12.7	4.76	5.16	1.6																○	●													





● Stock ○ Available Upon Order

## Turning Insert (Negative)

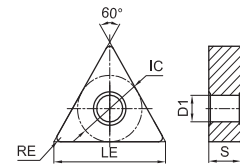
**TN**□□

Triangle 60° with Hole



Ordering Code	Dimension (mm)					Coated Carbides															Carbides	Cermet																		
	LE	IC	S	D1	RE	GPT6110	GPT6120	GPT6130	GP1105	GP1115	GP1120	GP1225	GP1130	GP1135	GM1115	GM1125	GM1230	GM3215	GM3220	GM3225	GK1115	GK1120	GK1125	GST7115	GST7120	GST7130	GS3115	GNT7120	GN9110	GN9120	GN9130	GP31TM	GP91TM	GP92TM						
TNMG160308-GM	16.5	9.525	3.18	3.81	0.8																																			○
TNMG160312-GM	16.5	9.525	3.18	3.81	1.2																																			●
 TNMG160404-GM	16.5	9.525	4.76	3.81	0.4																																		● ●	
TNMG160408-GM	16.5	9.525	4.76	3.81	0.8																																			● ●
TNMG160412-GM	16.5	9.525	4.76	3.81	1.2																																			○ ●
TNMG220404-GM	22	12.7	4.76	5.16	0.4																																			●
TNMG220408-GM	22	12.7	4.76	5.16	0.8																																			○ ●
TNMG220412-GM	22	12.7	4.76	5.16	1.2																																			○ ○
 TNMG160404R-SV	16.5	9.525	4.76	3.81	0.4																																		● ● ● ● ○ ● ●	
TNMG160404L-SV	16.5	9.525	4.76	3.81	0.4																																			○ ● ● ● ● ○ ● ●
TNMG160408R-SV	16.5	9.525	4.76	3.81	0.8																																			○ ● ● ● ● ○ ● ●
TNMG160408L-SV	16.5	9.525	4.76	3.81	0.8																																			● ● ○
TNMG160404-SM	16.5	9.525	4.76	3.81	0.4																																			○
 TNMG160408-SM	16.5	9.525	4.76	3.81	0.8																																		○ ● ● ● ● ○ ● ●	
TNMG160412-SM	16.5	9.525	4.76	3.81	1.2																																			○ ○ ○ ● ●
TNMG220408-SM	22	12.7	4.76	5.16	0.8																																			● ● ● ● ● ○ ● ●
TNMG220412-SM	22	12.7	4.76	5.16	1.2																																			○ ○
TNMG220416-SM	22	12.7	4.76	5.16	1.6																																			○
 TNMG160404-TP	16.5	9.525	4.76	3.81	0.4																																		● ○	
TNMG160408-TP	16.5	9.525	4.76	3.81	0.8																																			● ○
 TNMG160404R-TS	16.5	9.525	4.76	3.81	0.4																																		● ●	
TNMG160404L-TS	16.5	9.525	4.76	3.81	0.4																																			● ●
TNMG160408R-TS	16.5	9.525	4.76	3.81	0.8																																			● ●
TNMG160408L-TS	16.5	9.525	4.76	3.81	0.8																																			● ●

● Stock ○ Available Upon Order

Turning Insert (Negative)

TN□□

Triangle 60° with Hole

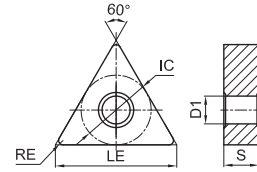

Ordering Code	Dimension (mm)					Coated Carbides												Carbides	Cermet																
	LE	IC	S	D1	RE	GPT6110	GPT6120	GPT6130	GPL105	GPL115	GPL120	GPL125	GPL130	GPL135	GM1115	GM1125	GM1230	GM3215	GM3220	GM3225	GK1115	GK1120	GK1125	GST7115	GST7120	GST7130	GS3115	GNT7120	GN9110	GN9120	GN9130	GP31TM	GP91TM	GP92TM	
	TNMG160404-LM	16.5	9.525	4.76	3.81	0.4																													
	TNMG160408-LM	16.5	9.525	4.76	3.81	0.8									●	●	●	●	●	●															
	TNMG160412-LM	16.5	9.525	4.76	3.81	1.2													●	●															
	TNMG160408-EM	16.5	9.525	4.76	3.81	0.8																													●
	TNMG160412-EM	16.5	9.525	4.76	3.81	1.2																													●
	TNMX160408-WMV	16.5	9.525	4.76	3.81	0.8																													○
	TNMX160412-WMV	16.5	9.525	4.76	3.81	1.2																													○
	TNMG160404-MK	16.5	9.525	4.76	3.81	0.4																													● ●
	TNMG160408-MK	16.5	9.525	4.76	3.81	0.8																													● ●
	TNMG160412-MK	16.5	9.525	4.76	3.81	1.2																													●
	TNMG160404-UK	16.5	9.525	4.76	3.81	0.4																													● ● ●
	TNMG160408-UK	16.5	9.525	4.76	3.81	0.8																													● ● ●
	TNMG160412-UK	16.5	9.525	4.76	3.81	1.2																													● ○
	TNMG160416-UK	16.5	9.525	4.76	3.81	1.6																													● ○ ○
	TNMG220408-UK	22	12.7	4.76	5.16	0.8																													● ○
	TNMG220412-UK	22	12.7	4.76	5.16	1.2																													
	TNMG220416-UK	22	12.7	4.76	5.16	1.6																													○ ●
	TNMG160408-LR	16.5	9.525	4.76	3.81	0.8										●																			● ●
	TNMG160412-LR	16.5	9.525	4.76	3.81	1.2																													○ ●
	TNMG220408-LR	22	12.7	4.76	5.16	0.8																													●
	TNMG160408-QR	16.5	9.525	4.76	3.81	0.8											●																	○ ●	
	TNMG160412-QR	16.5	9.525	4.76	3.81	1.2	○	○																											○ ●
	TNMG220408-QR	22	12.7	4.76	5.16	0.8	○ ● ●																												●
	TNMG220412-QR	22	12.7	4.76	5.16	1.2	○ ○ ●																												● ●
	TNMG220416-QR	22	12.7	4.76	5.16	1.6	○ ○ ●																												● ○ ○
	TNMG270608-QR	27.5	15.875	6.35	6.35	0.8																													○
	TNMG270612-QR	27.5	15.875	6.35	6.35	1.2																													● ○
	TNMG270616-QR	27.5	15.875	6.35	6.35	1.6																													●
TNMG330924-QR	33	19.05	9.52	7.94	2.4																													○	

● Stock ○ Available Upon Order

Turning Insert (Negative)

**TN**□□

Triangle 60° with Hole

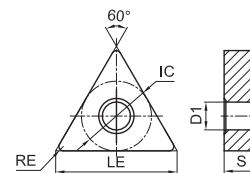

Ordering Code	Dimension (mm)					Coated Carbides													Carbides Cermet																	
	LE	IC	S	D1	RE	GPT6110	GPT6120	GPT6130	GP1105	GP1115	GP1120	GP1225	GP1130	GP1135	GM1115	GM1125	GM1230	GM3215	GM3220	GM3225	GK1115	GK1120	GK1125	GST7115	GST7120	GST7130	GS3115	GN7120	GN9110	GN9120	GN9130	GP31TM	GP91TM	GP92TM		
	TNMG160408-HK	16.5	9.525	4.76	3.81	0.8																		●	●	●										
TNMG160412-HK	16.5	9.525	4.76	3.81	1.2																		●	●	●											
TNMG220408-HK	22	12.7	4.76	5.16	0.8																		●	●	●											
TNMG220412-HK	22	12.7	4.76	5.16	1.2																		●	○	○											
TNMG220416-HK	22	12.7	4.76	5.16	1.6																		●	○	●											
TNMG270612-HK	27.5	15.875	6.35	6.35	1.2																		●	●												
TNMG270616-HK	27.5	15.875	6.35	6.35	1.6																		●	●												
TNMA110304	11	6.35	3.18	2.26	0.4																					○										
TNMA160308	16.5	9.525	3.18	3.81	0.8																		●	●												
TNMA160404	16.5	9.525	4.76	3.81	0.4																		●	●												
TNMA160408	16.5	9.525	4.76	3.81	0.8																		●	○	●											
TNMA160412	16.5	9.525	4.76	3.81	1.2																		●	●	●											
TNMA160416	16.5	9.525	4.76	3.81	1.6																		○	○	●											
TNMA220404	22	12.7	4.76	5.16	0.4																		●	●												
TNMA220408	22	12.7	4.76	5.16	0.8																		○	○												
TNMA220412	22	12.7	4.76	5.16	1.2																		○	○												
TNMA220416	22	12.7	4.76	5.16	1.6																		○	●												

● Stock ○ Available Upon Order

Turning Insert (Negative)

VN ◻ ◻

Rhombic 35° with Hole

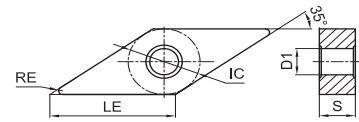

Ordering Code	Dimension (mm)					Coated Carbides												Carbides		Cermets															
	LE	IC	S	D1	RE	GPT6110	GPT6120	GPT6130	GP1105	GP1115	GP1120	GP1225	GP1130	GP1135	GM1115	GM1125	GM1230	GM3215	GM3220	GM3225	GK1115	GK1120	GK1125	GST7115	GST7120	GST7130	GS3115	GNT7120	GN9110	GN9120	GN9130	GP31TM	GP91TM	GP92TM	
VNMG160402-QF	16.6	9.525	4.76	3.81	0.2										●																				
VNMG160404-QF	16.6	9.525	4.76	3.81	0.4	●	●	●	●	●	○	●										○											●	○	
VNMG160408-QF	16.6	9.525	4.76	3.81	0.8	●	●	●	●	●	○	●										●											●	○	
VNMG220408-QF	22.1	12.7	4.76	5.16	0.8					●	○																								
VNMG160404-TF	16.6	9.525	4.76	3.81	0.4																												○	○	
VNMG160408-TF	16.6	9.525	4.76	3.81	0.8																												○	○	
VNMG160404-GF	16.6	9.525	4.76	3.81	0.4					●	○																								
VNMG160408-GF	16.6	9.525	4.76	3.81	0.8					●	●											●													
VNMG220404-GF	22.1	12.7	4.76	5.16	0.4					○																									
VNMG160404-SF	16.6	9.525	4.76	3.81	0.4															●	●							●							
VNMG160408-SF	16.6	9.525	4.76	3.81	0.8																●								●						
VNMG160404-YF	16.6	9.525	4.76	3.81	0.4																														
VNMG160408-YF	16.6	9.525	4.76	3.81	0.8																														
VNMG160404-SPL	16.6	9.525	4.76	3.81	0.4																													●	
VNMG160408-SPL	16.6	9.525	4.76	3.81	0.8																													●	
VNMG160404-EL	16.6	9.525	4.76	3.81	0.4																				●										
VNMG160408-EL	16.6	9.525	4.76	3.81	0.8																				●	●									
VNMG160412-EL	16.6	9.525	4.76	3.81	1.2																				●	●									
VNMG160404-SML	16.6	9.525	4.76	3.81	0.4																				●										
VNMG160408-SML	16.6	9.525	4.76	3.81	0.8																				●										
VNMG160412-SML	16.6	9.525	4.76	3.81	1.2																				●										
VNMG160404-QM	16.6	9.525	4.76	3.81	0.4	●	●	●	●	●	●	●		●									●										●	●	
VNMG160408-QM	16.6	9.525	4.76	3.81	0.8	●	●	●	●	●	●	●	●	●	●								●									○			
VNMG160412-QM	16.6	9.525	4.76	3.81	1.2	●	●	●	●	●	●	●		●									●												









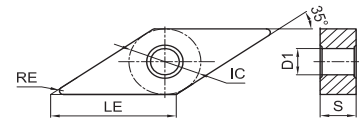











● Stock ○ Available Upon Order

Turning Insert (Negative)

**VN** □ □

Rhombic 35° with Hole



Ordering Code	Dimension (mm)					Coated Carbides																Carbides	Cermet											
	LE	IC	S	D1	RE	GPT6110	GPT6120	GPT6130	GP1105	GP1115	GP1120	GP1225	GP1130	GP1135	GM1115	GM1125	GM1230	GM3215	GM3220	GM3225	GK1115	GK1125	GST7115	GST7120	GST7130	GS3115	GNT7120	GN9110	GN9120	GN9130	GP31TM	GP91TM	GP92TM	
 VNMG160404-GM	16.6	9.525	4.76	3.81	0.4					○	●												●											
 VNMG160408-GM	16.6	9.525	4.76	3.81	0.8					●	●																							
 VNMG160412-GM	16.6	9.525	4.76	3.81	1.2					●	●																							
 VNMG160404-SM	16.6	9.525	4.76	3.81	0.4										○	○	●	○	●	●														
 VNMG160408-SM	16.6	9.525	4.76	3.81	0.8										○	○	○	●	○															
 VNMG160404-TP	16.6	9.525	4.76	3.81	0.4																											●	●	
 VNMG160408-TP	16.6	9.525	4.76	3.81	0.8																											○	●	
 VNMG160404-LM	16.6	9.525	4.76	3.81	0.4										○	●	○	○	●	●														
 VNMG160408-LM	16.6	9.525	4.76	3.81	0.8										○	●	○	○	●	●														
 VNMG160408-EM	16.6	9.525	4.76	3.81	0.8																			●	●	●								
 VNMG160412-EM	16.6	9.525	4.76	3.81	1.2																			●	●	●								
 VNMG160408-SMM	16.6	9.525	4.76	3.81	0.8																													
 VNMG160412-SMM	16.6	9.525	4.76	3.81	1.2																													
 VNMG160404-MK	16.6	9.525	4.76	3.81	0.4																													
 VNMG160408-MK	16.6	9.525	4.76	3.81	0.8																													
 VNMG160412-MK	16.6	9.525	4.76	3.81	1.2																													
 VNMG160404-UK	16.6	9.525	4.76	3.81	0.4																													
 VNMG160408-UK	16.6	9.525	4.76	3.81	0.8																													
 VNMG160412-UK	16.6	9.525	4.76	3.81	1.2																													
 VNMG160408-HK	16.6	9.525	4.76	3.81	0.8																													
 VNMG160412-HK	16.6	9.525	4.76	3.81	1.2																													









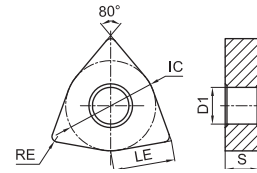

● Stock ○ Available Upon Order

Turning Insert (Negative)

**WN** □ □

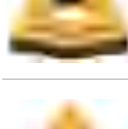
Trigon 80° with Hole



Ordering Code	Dimension (mm)					Coated Carbides																Carbides		Cermets													
	LE	IC	S	D1	RE	GPT6110	GPT6120	GPT6130	GP1105	GP1115	GP1120	GP1225	GP1130	GP1135	GM1115	GM1125	GM1230	GM3215	GM3220	GM3225	GK1115	GK1120	GK1125	GST7115	GST7120	GST7130	GS3115	GNT7120	GN9110	GN9120	GN9130	GP31TM	GP91TM	GP92TM			
 WNMG060404-QF	6.5	9.525	4.76	3.81	0.4	○	●	●	○	●																											
WNMG060408-QF	6.5	9.525	4.76	3.81	0.8	○	●	●	○	●																											
 WNMG080404-QF	8.7	12.7	4.76	5.16	0.4	●	●	●	●	○	●																								●	○	
WNMG080408-QF	8.7	12.7	4.76	5.16	0.8	●	●	●	●	○	●																								●	●	
WNMG080404-TF	8.7	12.7	4.76	5.16	0.4																														○	○	
WNMG080408-TF	8.7	12.7	4.76	5.16	0.8																														○	○	
WNMG06T304-GF	6.5	9.525	3.97	3.81	0.4					●	○																										
 WNMG06T308-GF	6.5	9.525	3.97	3.81	0.8					○	●																										
WNMG060404-GF	6.5	9.525	4.76	3.81	0.4					○																											
WNMG060408-GF	6.5	9.525	4.76	3.81	0.8					○																											
 WNMG080404-GF	8.7	12.7	4.76	5.16	0.4					●	○																										
WNMG080408-GF	8.7	12.7	4.76	5.16	0.8					●	●																										
 WNMG060404-SF	6.5	9.525	4.76	3.81	0.4													○																			
WNMG060408-SF	6.5	9.525	4.76	3.81	0.8													○																			
 WNMG080404-SF	8.7	12.7	4.76	5.16	0.4													●	●																		
WNMG080408-SF	8.7	12.7	4.76	5.16	0.8													●																			
 WNMG080404-YF	8.7	12.7	4.76	5.16	0.4													●	●																		
WNMG080408-YF	8.7	12.7	4.76	5.16	0.8													●	●																		
 WNMG080404-SPL	8.7	12.7	4.76	5.16	0.4																																●
WNMG080408-SPL	8.7	12.7	4.76	5.16	0.8																																●
 WNMG080404-EL	8.7	12.7	4.76	5.16	0.4																																
WNMG080408-EL	8.7	12.7	4.76	5.16	0.8																																
WNMG080412-EL	8.7	12.7	4.76	5.16	1.2																																
 WNMG080404-SML	8.7	12.7	4.76	5.16	0.4																																
WNMG080408-SML	8.7	12.7	4.76	5.16	0.8																																
 WNMG080412-SML	8.7	12.7	4.76	5.16	1.2																																

● Stock ○ Available Upon Order

Turning Insert (Negative)

**WN** □ □

Trigon 80° with Hole

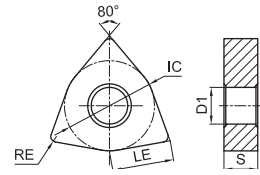

Ordering Code	Dimension (mm)					Coated Carbides														Carbides	Cermet																	
	LE	IC	S	D1	RE	GPT6110	GPT6120	GPT6130	GP1105	GP1115	GP1120	GP1225	GP1130	GP1135	GM1115	GM1125	GM1230	GM3215	GM3220	GM3225	GK1115	GK1120	GK1125	GST7115	GST7120	GST7130	GS3115	GNT7120	GN9110	GN9120	GN9130	GP31TM	GP91TM	GP92TM				
WNMG060404-QM	6.5	9.525	4.76	3.81	0.4	○	○	●	○	●	○										●																	
WNMG060408-QM	6.5	9.525	4.76	3.81	0.8	○	○	●	●	●	○	●	○																									
WNMG060412-QM	6.5	9.525	4.76	3.81	1.2	○	○	○	○	○																												
WNMG080404-QM	8.7	12.7	4.76	5.16	0.4	●	●	●	●	●	●	●	●	●	○						●														●			
WNMG080408-QM	8.7	12.7	4.76	5.16	0.8	●	●	●	●	●	●	●	●	●	●	●					●													●	●			
WNMG080412-QM	8.7	12.7	4.76	5.16	1.2	●	●	●	●	●	●	●	●	●							●																	
WNMG080416-QM	8.7	12.7	4.76	5.16	1.6	●	●	●	○	●	○																											
WNMG06T304-GM	6.5	9.525	3.97	3.81	0.4			○	●												●																	
WNMG06T308-GM	6.5	9.525	3.97	3.81	0.8			○	●												●																	
WNMG06T312-GM	6.5	9.525	3.97	3.81	1.2			○	●												○																	
WNMG060404-GM	6.5	9.525	4.76	3.81	0.4			○	●																													
WNMG060408-GM	6.5	9.525	4.76	3.81	0.8			○	●																													
WNMG080404-GM	8.7	12.7	4.76	5.16	0.4			●	●																													
WNMG080408-GM	8.7	12.7	4.76	5.16	0.8			●	●												●																	
WNMG080412-GM	8.7	12.7	4.76	5.16	1.2			●	●																													
WNMG080416-GM	8.7	12.7	4.76	5.16	1.6			●	●																													
WNMG080408R-SV	8.7	12.7	4.76	5.16	0.8			●	●																													
WNMG080408L-SV	8.7	12.7	4.76	5.16	0.8			●	●																													

● Stock ○ Available Upon Order





Turning Insert (Negative)

**WN** □ □  
Trigon 80° with Hole

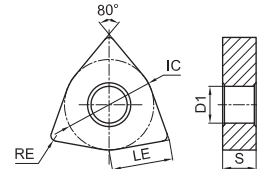

Ordering Code	Dimension (mm)					Coated Carbides														Carbides	Cermet															
	LE	IC	S	D1	RE	GPT6110	GPT6120	GPT6130	GP1105	GP1115	GP1120	GP1225	GP1130	GP1135	GM1115	GM1125	GM1230	GM3215	GM3220	GM3225	GK1115	GK1120	GK1125	GST7115	GST7120	GST7130	GS3115	GNT7120	GN9110	GN9120	GN9130	GP31TM	GP91TM	GP92TM		
	WNMG080404-UK	8.7	12.7	4.76	5.16	0.4																														●●●
	WNMG080408-UK	8.7	12.7	4.76	5.16	0.8																														●●●
	WNMG080412-UK	8.7	12.7	4.76	5.16	1.2																														
	WNMG080408-LR	8.7	12.7	4.76	5.16	0.8																														●●
	WNMG080412-LR	8.7	12.7	4.76	5.16	1.2																														●●
	WNMG080408-QR	8.7	12.7	4.76	5.16	0.8				○	●	●																								
	WNMG080412-QR	8.7	12.7	4.76	5.16	1.2				●	●	●																								
	WNMG080416-QR	8.7	12.7	4.76	5.16	1.6					●	○																								
	WNMG06T308-HK	6.5	9.525	3.97	3.81	0.8																														●●
	WNMG060408-HK	6.5	9.525	4.76	3.81	0.8																														●●
	WNMG080408-HK	8.7	12.7	4.76	5.16	0.8																														●●●
	WNMG080412-HK	8.7	12.7	4.76	5.16	1.2																														●●●
	WNMA06T304	6.5	9.525	3.97	3.81	0.4																													●	
	WNMA060404	6.5	9.525	4.76	3.81	0.4																													●●	
	WNMA060408	6.5	9.525	4.76	3.81	0.8																													●●	
	WNMA080404	8.7	12.7	4.76	5.16	0.4																													●●	
	WNMA080408	8.7	12.7	4.76	5.16	0.8																													●●●	
	WNMA080412	8.7	12.7	4.76	5.16	1.2																													●●●	
	WNMA080416	8.7	12.7	4.76	5.16	1.6																													●●○	

● Stock ○ Available Upon Order

Turning Insert (Positive)



Rhombic 80° with Hole

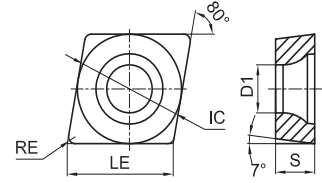

Ordering Code	Dimension (mm)					Coated Carbidés													Carbides	Cermet																	
	LE	IC	S	D1	RE	GPT6110	GPT6120	GPT6130	GP1105	GP1115	GP1120	GP1225	GP1130	GP1135	GM1115	GM1125	GM1230	GM3215	GM3220	GM3225	GK1115	GK1120	GK1125	GST7115	GST7120	GST7130	GS3115	GNT7120	GN9110	GN9120	GN9130	GP31TM	GP91TM	GP92TM			
	CCMT060202-MM	6.5	6.35	2.38	2.8	0.2	○	●	●						●			●	●															○	●		
	CCMT060204-MM	6.5	6.35	2.38	2.8	0.4	●	●	●						○			●	●																●	●	
	CCMT060208-MM	6.5	6.35	2.38	2.8	0.8	○	●	○									●	●																	●	○
	CCMT09T302-MM	9.7	9.525	3.97	4.4	0.2	●	●	●										●	●																●	●
	CCMT09T304-MM	9.7	9.525	3.97	4.4	0.4	●	●	●										●	●																●	●
	CCMT09T308-MM	9.7	9.525	3.97	4.4	0.8	●	●	●									●	●															○	●		
	CCMT060202-SPL	6.5	6.35	2.38	2.8	0.2																														●	
	CCMT060204-SPL	6.5	6.35	2.38	2.8	0.4																														●	
	CCMT09T302-SPL	9.7	9.525	3.97	4.4	0.2																														●	
	CCMT09T304-SPL	9.7	9.525	3.97	4.4	0.4																														●	
	CCMT09T308-SPL	9.7	9.525	3.97	4.4	0.8																													●		
	CCMT060202-GP	6.5	6.35	2.38	2.8	0.2	●	○	○	●					○	○			●																●	●	
	CCMT060204-GP	6.5	6.35	2.38	2.8	0.4	●	●	○	●	●	●	●	●	●	●	●	●	●	●	●	○	○													●	●
	CCMT060208-GP	6.5	6.35	2.38	2.8	0.8	●	○	○	●						●	●	○	●	●	●	○	○												○	○	
	CCMT09T302-GP	9.7	9.525	3.97	4.4	0.2	●	○	○	●	●				●	●			●																○	○	
	CCMT09T304-GP	9.7	9.525	3.97	4.4	0.4	●	○	○	●	●	○			●	●	●	●	●	●	●	●	●	●	●	●	●	●	●	●	●	●	●	●	●	●	●
	CCMT09T308-GP	9.7	9.525	3.97	4.4	0.8	●	●	○	●	●	●	●	●	●	●	○	●	●	●	●	●	●	●	●	●	●	●	●	●	●	●	●	●	○	●	
	CCMT120404-GP	12.9	12.7	4.76	5.56	0.4	●	●	○	●	●	●			●	●	●	●	●	●	●	○	○												○	○	
	CCMT120408-GP	12.9	12.7	4.76	5.56	0.8	●	●	○	●	●	●			●	●	●	●	●	●	●	●	●	●	●	●	●	●	●	●	●	●	●	●	○	●	
	CCMT120412-GP	12.9	12.7	4.76	5.56	1.2	●	○	○	●	○				●	●			●	●																	
	CCGT060202-GP	6.5	6.35	2.38	2.8	0.2													●																		
	CCGT060204-GP	6.5	6.35	2.38	2.8	0.4													●																		
	CCGT060208-GP	6.5	6.35	2.38	2.8	0.8													●																		
	CCGT09T302-GP	9.7	9.525	3.97	4.4	0.2													●																		
	CCGT09T304-GP	9.7	9.525	3.97	4.4	0.4													●																		
	CCGT09T308-GP	9.7	9.525	3.97	4.4	0.8													●																		
	CCGT120404-GP	12.9	12.7	4.76	5.56	0.4													●																		
	CCGT120408-GP	12.9	12.7	4.76	5.56	0.8														○																	
		CCMT060202-TP	6.5	6.35	2.38	2.8	0.2																													●	●
		CCMT060204-TP	6.5	6.35	2.38	2.8	0.4																													●	●
CCMT060208-TP		6.5	6.35	2.38	2.8	0.8																														●	●
CCMT09T302-TP		9.7	9.525	3.97	4.4	0.2																														●	●
CCMT09T304-TP		9.7	9.525	3.97	4.4	0.4																														●	●
CCMT09T308-TP		9.7	9.525	3.97	4.4	0.8																														●	●
CCMT120404-TP		12.9	12.7	4.76	5.56	0.4																														●	●
CCMT120408-TP		12.9	12.7	4.76	5.56	0.8																														●	●

● Stock ○ Available Upon Order

## Turning Insert (Positive)



Rhombic 80° with Hole

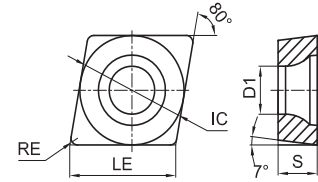

Ordering Code	Dimension (mm)					Coated Carbides															Carbides	Cermet																	
	LE	IC	S	D1	RE	GPT6110	GPT6120	GPT6130	GPL105	GPL115	GPL120	GPL225	GPL130	GPL135	GM1115	GM1125	GM1230	GM3215	GM3220	GM3225	GK1115	GK1120	GK1125	GST7115	GST7120	GST7130	GS3115	GNT7120	GN9110	GN9120	GN9130	GP31TM	GP91TM	GP92TM					
CCMT060204-KM	6.5	6.35	2.38	2.8	0.4																●	○	○																
CCMT09T304-KM	9.7	9.525	3.97	4.4	0.4																●	●	●																
CCMT09T308-KM	9.7	9.525	3.97	4.4	0.8																●	●	●																
CCMT120404-KM	12.9	12.7	4.76	5.56	0.4																●																		
CCMT120408-KM	12.9	12.7	4.76	5.56	0.8																●	●	●																
CCMT120412-KM	12.9	12.7	4.76	5.56	1.2																●	●	●																
CCGX060202-AL	6.5	6.35	2.38	2.8	0.2																								○	●									
CCGX060204-AL	6.5	6.35	2.38	2.8	0.4																								○	●	●	○							
CCGX060208-AL	6.5	6.35	2.38	2.8	0.8																								○										
CCGX09T302-AL	9.7	9.525	3.97	4.4	0.2																								○	○	●								
CCGX09T304-AL	9.7	9.525	3.97	4.4	0.4																								○	○	●	●							
CCGX09T308-AL	9.7	9.525	3.97	4.4	0.8																								○	○	●								
CCGX120402-AL	12.9	12.7	4.76	5.5	0.2																								○	●									
CCGX120404-AL	12.9	12.7	4.76	5.5	0.4																								○	○	●	○							
CCGX120408-AL	12.9	12.7	4.76	5.5	0.8																								○	○	●	●							

● Stock ○ Available Upon Order



Rhombic 80° with Hole

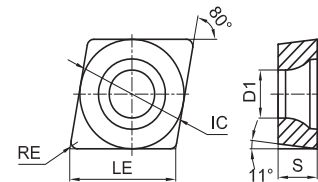

Ordering Code	Dimension (mm)					Coated Carbides															Carbides	Cermet														
	LE	IC	S	D1	RE	GPT6110	GPT6120	GPT6130	GPL105	GPL115	GPL120	GPL225	GPL130	GPL135	GM1115	GM1125	GM1230	GM3215	GM3220	GM3225	GK1115	GK1120	GK1125	GST7115	GST7120	GST7130	GS3115	GNT7120	GN9110	GN9120	GN9130	GP31TM	GP91TM	GP92TM		
CPGT060204-GP	6.5	6.35	2.38	2.8	0.4																●															
CPGT060208-GP	6.5	6.35	2.38	2.8	0.8																	○														
CPGT09T302-GP	9.7	9.525	3.97	4.4	0.2																	●														
CPGT09T304-GP	9.7	9.525	3.97	4.4	0.4																	●														
CPGT09T308-GP	9.7	9.525	3.97	4.4	0.8																															
CPGT120404-GP	12.9	12.7	4.76	5.56	0.4																															
CPGT120408-GP	12.9	12.7	4.76	5.56	0.8																															

● Stock ○ Available Upon Order

Turning Insert (Positive)

DC □ □

Rhombic 55° with Hole

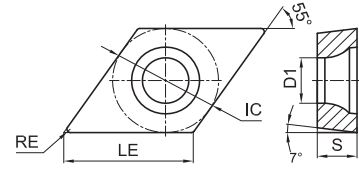

Ordering Code	Dimension (mm)					Coated Carbides														Carbides Cermet															
	LE	IC	S	D1	RE	GPT6110	GPT6120	GPT6130	GP1105	GP1115	GP1120	GP1225	GP1130	GP1135	GM1115	GM1125	GM1230	GM3215	GM3220	GM3225	GK1115	GK1125	GST7115	GST7120	GST7130	GS3115	GNT7120	GN9110	GN9120	GN9130	GP31TM	GP91TM	GP92TM		
DCMT070202-MM	7.8	6.35	2.38	2.8	0.2	○	●	●							○			●	●													●	●		
DCMT070204-MM	7.8	6.35	2.38	2.8	0.4	○	●	●							●			●	●													●	●		
DCMT070208-MM	7.8	6.35	2.38	2.8	0.8													●	●																
DCMT11T302-MM	11.6	9.525	3.97	4.4	0.2	○	●	●										●	●													●	●		
DCMT11T304-MM	11.6	9.525	3.97	4.4	0.4	●	●	●							●			●	●													●	●		
DCMT11T308-MM	11.6	9.525	3.97	4.4	0.8	●	●	●							●			●	●												○	●			
DCMT070204-SPL	7.8	6.35	2.38	2.8	0.4																													●	
DCMT11T302-SPL	11.6	9.525	3.97	4.4	0.2																													●	
DCMT11T304-SPL	11.6	9.525	3.97	4.4	0.4																													●	
DCMT11T308-SPL	11.6	9.525	3.97	4.4	0.8																													●	
DCMT070202-GP	7.8	6.35	2.38	2.8	0.2	●	○	○	●						●	○		●														○	○		
DCMT070204-GP	7.8	6.35	2.38	2.8	0.4	●	○	●	●						○	●	●	●	●	○													●	○	
DCMT070208-GP	7.8	6.35	2.38	2.8	0.8	●	○	●	●						●	●	○	●	○															●	
DCMT11T302-GP	11.6	9.525	3.97	4.4	0.2	●	○	●	●						○	○		●															●	●	
DCMT11T304-GP	11.6	9.525	3.97	4.4	0.4	●	●	○	●	●					●	●	●	●	●	●	●												●	●	
DCMT11T308-GP	11.6	9.525	3.97	4.4	0.8	●	●	○	●	●					●	●	○	●	●	○													●		
DCMT11T312-GP	11.6	9.525	3.97	4.4	1.2														●																
DCMT150404-GP	15.5	12.7	4.76	5.56	0.4		○		○						●	○																			
DCMT150408-GP	15.5	12.7	4.76	5.56	0.8	○	○		●						●	○																			
DCMT150412-GP	15.5	12.7	4.76	5.56	1.2										●	○																			
DCGT070202-GP	7.8	6.35	2.38	2.8	0.2														●																
DCGT070204-GP	7.8	6.35	2.38	2.8	0.4														●																
DCGT070208-GP	7.8	6.35	2.38	2.8	0.8															○															
DCGT11T302-GP	11.6	9.525	3.97	4.4	0.2														●																
DCGT11T304-GP	11.6	9.525	3.97	4.4	0.4														●																
DCGT11T308-GP	11.6	9.525	3.97	4.4	0.8														●																
DCMT070202-TP	7.8	6.35	2.38	2.8	0.2																												●	○	
DCMT070204-TP	7.8	6.35	2.38	2.8	0.4																												●	○	
DCMT070208-TP	7.8	6.35	2.38	2.8	0.8																												○	●	
DCMT11T302-TP	11.6	9.525	3.97	4.4	0.2																												●	●	
DCMT11T304-TP	11.6	9.525	3.97	4.4	0.4																												●	●	
DCMT11T308-TP	11.6	9.525	3.97	4.4	0.8																												●	○	
DCMT11T304-KM	11.6	9.525	3.97	4.4	0.4															●	○														
DCMT11T308-KM	11.6	9.525	3.97	4.4	0.8															●	●														

● Stock ○ Available Upon Order

## Turning Insert (Positive)

**DC** □ □

Rhombic 55° with Hole

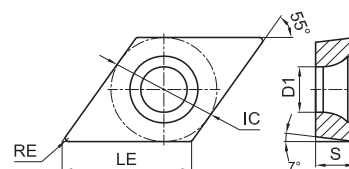

Ordering Code	Dimension (mm)					Coated Carbides																Carbides		Cermets											
	LE	IC	S	D1	RE	GPT6110	GPT6120	GPT6130	GP1105	GP1115	GP1120	GP1225	GP1130	GP1135	GM1115	GM1125	GM1230	GM3215	GM3220	GM3225	GK1115	GK1120	GK1125	GST7115	GST7120	GST7130	GS3115	GNT7120	GN9110	GN9120	GN9130	GP31TM	GP91TM	GP92TM	
DCGX070202-AL	7.8	6.35	2.38	2.8	0.2																								○	○					
DCGX070204-AL	7.8	6.35	2.38	2.8	0.4																								○	●	●				
DCGX070208-AL	7.8	6.35	2.38	2.8	0.8																								○	○					
DCGX11T302-AL	11.6	9.525	3.97	4.4	0.2																							○	○	●					
DCGX11T304-AL	11.6	9.525	3.97	4.4	0.4																							○	●	●	●				
DCGX11T308-AL	11.6	9.525	3.97	4.4	0.8																							○	●						

● Stock ○ Available Upon Order

Turning Insert (Positive)

**SC** □ □

Square 90° with Hole

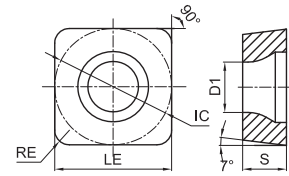

Ordering Code	Dimension (mm)					Coated Carbides														Carbides	Cermet																
	LE	IC	S	D1	RE	GPT6110	GPT6120	GPT6130	GP1105	GP1115	GP1120	GP1225	GP1130	GP1135	GM1115	GM1125	GM1230	GM3215	GM3220	GM3225	GK1115	GK1120	GK1125	GST7115	GST7120	GST7130	GS3115	GNT7120	GN9110	GN9120	GN9130	GP31TM	GP91TM	GP92TM			
SCMT09T304-MM	9.525	9.525	3.97	4.4	0.4	○	●	●													●	●															
SCMT09T308-MM	9.525	9.525	3.97	4.4	0.8	○	●	●													●	●															
SCMT09T304-GP	9.525	9.525	3.97	4.4	0.4	●	○	●	●	●	●	●	●	●	●	●	●	●	●	●	○	○	○	○	○	○	○	○	○	○	○	○	○	○	○	○	
SCMT09T308-GP	9.525	9.525	3.97	4.4	0.8	●	●	○	●	●	●	●	●	●	●	●	●	●	●	●	○	○	○	○	○	○	○	○	○	○	○	○	○	○	○	○	
SCMT120404-GP	12.7	12.7	4.76	5.56	0.4	●	○	●	●	●	●	●	●	●	●	●	○	○	○	○	○	○	○	○	○	○	○	○	○	○	○	○	○	○	○	○	
SCMT120408-GP	12.7	12.7	4.76	5.56	0.8	●	○	●	●	●	●	●	●	●	●	●	○	○	○	○	○	○	○	○	○	○	○	○	○	○	○	○	○	○	○	○	○
SCMT09T304-TP	9.525	9.525	3.97	4.4	0.4																														○		
SCMT09T308-TP	9.525	9.525	3.97	4.4	0.8																														●		
SCMT120404-TP	12.7	12.7	4.76	5.56	0.4																														○		
SCMT120408-TP	12.7	12.7	4.76	5.56	0.8																														○		
SCMT09T308-KM	9.525	9.525	3.97	4.4	0.8																●	●	●														
SCMT120408-KM	12.7	12.7	4.76	5.56	0.8																●	○	○														
SCMT120412-KM	12.7	12.7	4.76	5.56	1.2																●	●															
SCGX09T304-AL	9.525	9.525	3.97	4.4	0.4																														○	○	○
SCGX09T308-AL	9.525	9.525	3.97	4.4	0.8																														○	○	●
SCGX120404-AL	12.7	12.7	4.76	5.5	0.4																														○	○	
SCGX120408-AL	12.7	12.7	4.76	5.5	0.8																														○	○	○





● Stock ○ Available Upon Order

Turning Insert (Positive)

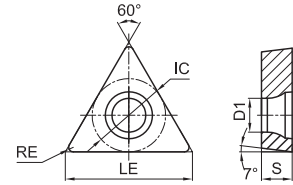
**TC** □ □

Triangle 60° with Hole



Ordering Code	Dimension (mm)					Coated Carbides															Carbides		Cermet												
	LE	IC	S	D1	RE	GPT6110	GPT6120	GPT6130	GP1105	GP1115	GP1120	GP1225	GP1130	GP1135	GM1115	GM1125	GM1230	GM3215	GM3220	GM3225	GK1115	GK1120	GK1125	GST7115	GST7120	GST7130	GS3115	GNT7120	GN9110	GN9120	GN9130	GP31TM	GP91TM	GP92TM	
 TCMT110202-MM	11	6.35	2.38	2.8	0.2	○	●	○																										●	○
TCMT110204-MM	11	6.35	2.38	2.8	0.4	●	●	●																										●	●
TCMT110208-MM	11	6.35	2.38	2.8	0.8																														
TCMT16T304-MM	16.5	9.525	3.97	4.4	0.4	●	●	●																											
TCMT16T308-MM	16.5	9.525	3.97	4.4	0.8	●	●	●					●																						
 TCMT110204-SPL	11	6.35	2.38	2.8	0.4																														●
TCMT090204-GP	9.6	5.56	2.38	2.5	0.4	●	○	●	●						●						●	○											●	●	
TCMT110202-GP	11	6.35	2.38	2.8	0.2	●	○								○						●														●
TCMT110204-GP	11	6.35	2.38	2.8	0.4	●	○	●	●						○	●	●	●	●	●														○	●
TCMT110208-GP	11	6.35	2.38	2.8	0.8	●	○	●	●						●	●	●	●	●	○	●	●												○	○
 TCMT16T304-GP	16.5	9.525	3.97	4.4	0.4	●	○	●	●						●	●	●	●	●	●	●													○	●
TCMT16T308-GP	16.5	9.525	3.97	4.4	0.8	●	○	●	●						●	●	●	●	●	●	●	●												○	○
TCMT16T312-GP	16.5	9.525	3.97	4.4	1.2	●	○		●												●	●													
TCMT220408-GP	22	12.7	4.76	5.56	0.8	○	○	●	●						●						●	○													
TCMT220412-GP	22	12.7	4.76	5.56	1.2			●																											
TCGT090204-GP	9.6	5.56	2.38	2.5	0.4																●														
TCGT110202-GP	11	6.35	2.38	2.8	0.2																●														
TCGT110204-GP	11	6.35	2.38	2.8	0.4																●														
TCGT110208-GP	11	6.35	2.38	2.8	0.8																●														
TCGT16T304-GP	16.5	9.525	3.97	4.4	0.4																●														
TCGT16T308-GP	16.5	9.525	3.97	4.4	0.8																	○													
TCMT090202-TP	9.6	5.56	2.38	2.5	0.2																													○	●
TCMT090204-TP	9.6	5.56	2.38	2.5	0.4																													○	○
 TCMT090208-TP	9.6	5.56	2.38	2.5	0.8																													●	●
TCMT110204-TP	11	6.35	2.38	2.8	0.4																													●	○
TCMT110208-TP	11	6.35	2.38	2.8	0.8																													●	●
TCMT16T304-TP	16.5	9.525	3.97	4.4	0.4																													○	○
TCMT16T308-TP	16.5	9.525	3.97	4.4	0.8																													●	●
 TCMT110204-KM	11	6.35	2.38	2.8	0.4																●														
TCMT16T304-KM	16.5	9.525	3.97	4.4	0.4																●														
TCMT16T308-KM	16.5	9.525	3.97	4.4	0.8																●														

● Stock ○ Available Upon Order











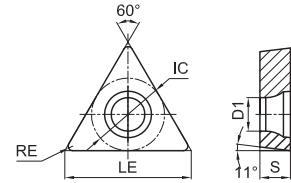











Turning Insert (Positive)

**TP** □ □

Triangle 60° with Hole



Ordering Code	Dimension (mm)					Coated Carbides															Carbides	Cermet															
	LE	IC	S	D1	RE	GPT6110	GPT6120	GPT6130	GP1105	GP1115	GP1120	GP1225	GP1130	GP1135	GM1115	GM1125	GM1230	GM3215	GM3220	GM3225	GK1115	GK1120	GK1125	GST7115	GST7120	GST7130	GS3115	GNT7120	GN9110	GN9120	GN9130	GP31TM	GP91TM	GP92TM			
 TPMT110202-MM	11	6.35	2.38	2.8	0.2	○	○	○													●																
 TPMT110204-MM	11	6.35	2.38	2.8	0.4	○	○	○													●																
 TPMT110304-MM	11	6.35	3.18	3.4	0.4	●	●	○																									●	●			
 TPMT090204-SPL	9.6	5.56	2.38	2.5	0.4																														●		
 TPMT110304-SPL	11	6.35	3.18	3.4	0.4																															●	
 TPGT110204-GP	11	6.35	2.38	2.8	0.4																○																
 TPGT110208-GP	11	6.35	2.38	2.8	0.8																○																
 TPGT16T304-GP	16.5	9.525	3.97	4.4	0.4																○																
 TPGT16T308-GP	16.5	9.525	3.97	4.4	0.8																○																
 TPMT090202-TP	9.6	5.56	2.38	2.5	0.2																													○	●		
 TPMT090204-TP	9.6	5.56	2.38	2.5	0.4																														●	●	
 TPMT090208-TP	9.6	5.56	2.38	2.5	0.8																														●	○	
 TPMT110302-TP	11	6.35	3.18	3.4	0.2																														●	●	
 TPMT110304-TP	11	6.35	3.18	3.4	0.4																														●	●	
 TPMT110308-TP	11	6.35	3.18	3.4	0.8																													○	●		
 TPMT160302-TP	16.5	9.525	3.18	4.4	0.2																														●	●	
 TPMT160304-TP	16.5	9.525	3.18	4.4	0.4																													○	●		
 TPMT160308-TP	16.5	9.525	3.18	4.4	0.8																														●	●	





● Stock ○ Available Upon Order

Turning Insert (Positive)

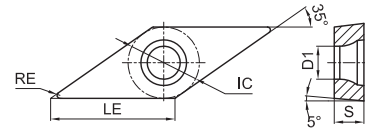
**VB** □ □

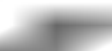
Rhombic 35° with Hole



Ordering Code	Dimension (mm)					Coated Carbides																Carbides	Cermet														
	LE	IC	S	D1	RE	GPT6110	GPT6120	GPT6130	GP1105	GP1115	GP1120	GP1225	GP1130	GP1135	GM1115	GM1125	GM1230	GM3215	GM3220	GM3225	GK1115	GK1120	GK1125	GST7115	GST7120	GST7130	GS3115	GNT7120	GN9110	GN9120	GN9130	GP31TM	GP91TM	GP92TM			
 VBMT110304-MM	11.2	6.35	3.18	2.8	0.4	●	●	○													●	●												●	●		
VBMT110308-MM	11.2	6.35	3.18	2.8	0.8																●																
VBMT160402-MM	16.6	9.525	4.76	4.4	0.2																●	●															
VBMT160404-MM	16.6	9.525	4.76	4.4	0.4	●	●	●													●	●												●	●		
VBMT160408-MM	16.6	9.525	4.76	4.4	0.8	●	●	●													●	●												●	●		
 VBMT110304-SPL	11.2	6.35	3.18	2.8	0.4																														●		
VBMT160404-SPL	16.6	9.525	4.76	4.4	0.4																														●		
 VBMT160404-GP	16.6	9.525	4.76	4.4	0.4	●	○	○	●	○	●				●	●	○	●	●	●	●	○												●	○		
VBMT160408-GP	16.6	9.525	4.76	4.4	0.8	●	○	○	●	●	●				○	●	●	●	●	●	○														●	●	
VBMT160412-GP	16.6	9.525	4.76	4.4	1.2	●	○	○	●	○											●																
 VBMT110304-TP	11.2	6.35	3.18	2.8	0.4																														●	●	
VBMT110308-TP	11.2	6.35	3.18	2.8	0.8																														●	●	
VBMT160402-TP	16.6	9.525	4.76	4.4	0.2																														○	○	
VBMT160404-TP	16.6	9.525	4.76	4.4	0.4																															●	●
VBMT160408-TP	16.6	9.525	4.76	4.4	0.8																															●	○
 VBMT160408-KM	16.6	9.525	4.76	4.4	0.8																●	●															

● Stock ○ Available Upon Order

Turning Insert (Positive)

**VC** □ □

Rhombic 35° with Hole

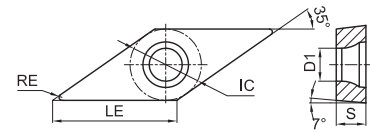

Ordering Code	Dimension (mm)					Coated Carbidés																Carbides	Cermet													
	LE	IC	S	D1	RE	GPT6110	GPT6120	GPT6130	GP1105	GP1115	GP1120	GP1225	GP1130	GP1135	GM1115	GM1125	GM1230	GM3215	GM3220	GM3225	GK1115	GK1120	GK1125	GST7115	GST7120	GST7130	GS3115	GNT7120	GN9110	GN9120	GN9130	GP31TM	GP91TM	GP92TM		
VCMT160404-MM	16.6	9.525	4.76	4.4	0.4	●	●	○																												
VCMT160408-MM	16.6	9.525	4.76	4.4	0.8	●	●	○																												
VCMT110304-SPL	11.2	6.35	3.18	2.8	0.4																														●	
VCMT110304-GP	11.2	6.35	3.18	2.8	0.4	●	○	●	●						●	●					●														○ ●	
VCMT110308-GP	11.2	6.35	3.18	2.8	0.8		○								●	○					○														○ ●	
VCMT160404-GP	16.6	9.525	4.76	4.4	0.4	●	○	●	●						●	●					●														○ ●	
VCMT160408-GP	16.6	9.525	4.76	4.4	0.8	●	○	●	●						●	●					●														○	
VCGT110304-GP	11.2	6.35	3.18	2.8	0.4																●															
VCGT160404-GP	16.6	9.525	4.76	4.4	0.4																●															
VCGT160408-GP	16.6	9.525	4.76	4.4	0.8																○															
VCMT160404-KM	16.6	9.525	4.76	4.4	0.4																●															
VCMT160408-KM	16.6	9.525	4.76	4.4	0.8																●															
VCGX110302-AL	11.2	6.35	3.18	2.8	0.2																						○	●								
VCGX110304-AL	11.2	6.35	3.18	2.8	0.4																						○	○	●	○						
VCGX110308-AL	11.2	6.35	3.18	2.8	0.8																						○	○								
VCGX160402-AL	16.6	9.525	4.76	4.4	0.2																						○	○								
VCGX160404-AL	16.6	9.525	4.76	4.4	0.4																						○	○	●	●						
VCGX160408-AL	16.6	9.525	4.76	4.4	0.8																						○	○	●	○						
VCGX160412-AL	16.6	9.525	4.76	4.4	1.2																						○	●								
VCGX220512-AL	22.1	12.7	5.56	5.6	1.2																						○									
VCGX220516-AL	22.1	12.7	5.56	5.6	1.6																						○									
VCGX220530-AL	22.1	12.7	5.56	5.6	3.0																						○	●								

● Stock ○ Available Upon Order

Turning Insert (Positive)

**WC** □ □

Trigon 80° with Hole

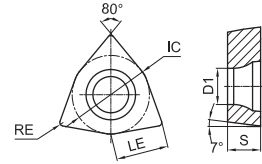

Ordering Code	Dimension (mm)					Coated Carbides															Carbides	Cermet													
	LE	IC	S	D1	RE	GPT6110	GPT6120	GPT6130	GP1105	GP1115	GP1120	GP1225	GP1130	GP1135	GM1115	GM1125	GM1230	GM3215	GM3220	GM3225	GK1115	GK1120	GK1125	GST7115	GST7120	GST7130	GS3115	GNT7120	GN9110	GN9120	GN9130	GP31TM	GP91TM	GP92TM	
WCMT06T304-GP	6.5	9.525	3.97	4.4	0.4	●	○	○	○						●	○					○													○	○
WCMT06T308-GP	6.5	9.525	3.97	4.4	0.8	●	○	○	○						●						○														●



● Stock ○ Available Upon Order

## Recommended Cutting Data (Negative Inserts)

ISO	Workpiece Materials	Hardness	Application Range	Cutting Mode	Chip Breaker	Grade	Min-Optimum-Max					
							Cutting Speed Vc(m/min)	Cutting Depth ap(mm)	Feeding Rate f(mm/rev)			
P	Mild Steel	≤HB180	Finishing Machining	Continuous	QF	GPT6110	240-300-400	0.40-0.80-2.00	0.08-0.15-0.35			
						GP1105	220-280-380	0.40-0.80-2.00	0.08-0.15-0.35			
						GP1115	200-260-360	0.40-0.80-2.00	0.08-0.15-0.35			
				General		GPT6120	200-280-380	0.40-0.80-2.00	0.08-0.15-0.35			
						GP1120	200-260-360	0.40-0.80-2.00	0.08-0.15-0.35			
						GP1225	180-240-320	0.40-0.80-2.00	0.08-0.15-0.35			
				Intermittent		GPT6130	180-240-320	0.40-0.80-2.00	0.08-0.15-0.35			
						GP1130	180-240-320	0.40-0.80-2.00	0.08-0.15-0.35			
						GP1135	170-220-300	0.40-0.80-2.00	0.08-0.15-0.35			
				Continuous	TF	GP31TM	220-300-380	0.30-0.70-1.80	0.07-0.14-0.35			
						GP91TM	200-280-350	0.30-0.70-1.80	0.07-0.14-0.35			
						GF	GP1115	200-260-360	0.80-1.20-2.50	0.10-0.20-0.35		
				GP1225	180-240-320		0.80-1.20-2.50	0.10-0.20-0.35				
				Continuous	SPL	GP92TM	180-240-300	0.40-1.00-2.30	0.12-0.20-0.30			
						Semi-finished	Continuous	QM	GPT6110	220-280-380	0.80-2.00-4.00	0.15-0.20-0.40
									GP1105	200-260-360	0.80-2.00-4.00	0.15-0.20-0.40
				GP1115	180-230-320				0.80-2.00-4.00	0.15-0.20-0.40		
				General	GP31TM		210-280-330		0.50-1.20-2.50	0.10-0.18-0.30		
			GP91TM		200-260-330		0.50-1.50-3.00		0.15-0.22-0.35			
			GPT6120		180-250-340		0.80-2.00-4.00		0.15-0.20-0.40			
			Intermittent	GP1120	180-230-320		0.80-2.00-4.00		0.15-0.20-0.40			
				GP1225	160-210-300		0.80-2.00-4.00		0.15-0.20-0.40			
				GPT6130	160-230-300		0.80-2.00-4.00		0.15-0.20-0.40			
			Intermittent	GM	GP1130		160-210-300	0.80-2.00-4.00	0.15-0.20-0.40			
					GP1135		150-190-280	0.80-2.00-4.00	0.15-0.20-0.40			
					GP1115		180-230-320	1.00-2.00-4.00	0.18-0.22-0.40			
			Intermittent	SV	GP1225		160-210-300	1.00-2.00-4.00	0.18-0.22-0.40			
					TP		GP1225	160-200-300	1.00-2.50-4.50	0.18-0.25-0.45		
							GP31TM	220-300-380	0.30-1.00-3.00	0.05-0.12-0.28		
			Continuous	TS	GP91TM		200-280-350	0.30-1.20-3.00	0.05-0.15-0.28			
					GP31TM		200-280-350	0.50-1.00-3.00	0.10-0.15-0.35			
					GP91TM		200-260-330	0.50-1.20-3.00	0.10-0.20-0.35			
			Rough Finishing	Continuous	QR	GPT6110	150-220-280	1.50-3.50-6.00	0.20-0.30-0.60			
						GP1105	130-190-270	1.50-3.50-6.00	0.20-0.30-0.60			
						GP1115	120-180-250	1.50-3.50-6.00	0.20-0.30-0.60			
						General	GPT6120	140-210-270	1.50-3.50-6.00	0.20-0.30-0.60		
							GP1225	120-170-250	1.50-3.50-6.00	0.20-0.30-0.60		
							GPT6130	120-190-250	1.50-3.50-6.00	0.20-0.30-0.60		
				Intermittent		GP1130	120-170-250	1.50-3.50-6.00	0.20-0.30-0.60			
						GP1135	110-150-230	1.50-3.50-6.00	0.20-0.30-0.60			
						Heavy Machining	Continuous	QH	GPT6110	100-170-230	3.00-6.00-12.0	0.35-0.60-1.10
				GP1105	100-150-240				3.00-6.00-12.0	0.35-0.60-1.10		
				GP1115	90-150-210				3.00-6.00-12.0	0.35-0.60-1.10		
				General	GPT6120		100-160-220		3.00-6.00-12.0	0.35-0.60-1.10		
			GP1225		90-140-210		3.00-6.00-12.0		0.35-0.60-1.10			
			GPT6130		90-150-210		3.00-6.00-12.0		0.35-0.60-1.10			
			Intermittent	GP1135	80-130-190	3.00-6.00-12.0	0.35-0.60-1.10					

## Recommended Cutting Data (Negative Inserts)

ISO	Workpiece Materials	Hardness	Application Range	Cutting Mode	Chip Breaker	Grade	Min-Optimum-Max		
							Cutting Speed Vc(m/min)	Cutting Depth ap(mm)	Feeding Rate f(mm/rev)
P	Carbon Steel, Alloy Steel	HB180-280	Finishing Machining	Continuous	QF	GPT6110	220-270-360	0.40-0.80-2.00	0.08-0.15-0.35
						GP1105	200-250-340	0.40-0.80-2.00	0.08-0.15-0.35
						GP1115	180-230-320	0.40-0.80-2.00	0.08-0.15-0.35
				General		GPT6120	180-250-340	0.40-0.80-2.00	0.08-0.15-0.35
						GP1120	180-230-320	0.40-0.80-2.00	0.08-0.15-0.35
						GP1225	160-200-300	0.40-0.80-2.00	0.08-0.15-0.35
				Intermittent		GPT6130	160-220-300	0.40-0.80-2.00	0.08-0.15-0.35
						GP1130	180-240-320	0.40-0.80-2.00	0.08-0.15-0.35
						GP1135	150-200-280	0.40-0.80-2.00	0.08-0.15-0.35
				Continuous	GF	GP1115	180-230-320	0.80-1.20-2.50	0.10-0.20-0.35
						GP1225	160-200-300	0.80-1.20-2.50	0.10-0.20-0.35
						GP92TM	160-210-290	0.40-1.00-2.30	0.12-0.20-0.30
			Semi-finished	Continuous	QM	GPT6110	180-250-340	0.80-2.00-4.00	0.15-0.22-0.40
						GP1105	160-230-320	0.80-2.00-4.00	0.15-0.22-0.40
						GP1115	140-210-300	0.80-2.00-4.00	0.15-0.20-0.40
						GP31TM	200-250-330	0.50-1.20-2.50	0.10-0.18-0.30
						GP91TM	180-230-310	0.50-1.50-3.00	0.15-0.20-0.35
						GPT6120	140-230-320	0.80-2.00-4.00	0.15-0.20-0.40
				General		GP1120	140-210-300	0.80-2.00-4.00	0.15-0.20-0.40
						GP1225	120-190-280	0.80-2.00-4.00	0.15-0.20-0.40
						GPT6130	120-210-280	0.80-2.00-4.00	0.15-0.20-0.40
				Intermittent	GM	GP1130	120-190-280	0.80-2.00-4.00	0.15-0.20-0.40
						GP1135	100-170-260	0.80-2.00-4.00	0.15-0.20-0.40
						GP1115	140-210-300	1.00-2.00-4.00	0.18-0.22-0.40
			Continuous	SV	GP1225	120-190-280	1.00-2.00-4.00	0.18-0.22-0.40	
					GP1225	120-180-280	1.00-2.50-4.50	0.18-0.25-0.45	
					GP31TM	200-270-350	0.30-1.00-2.50	0.05-0.12-0.28	
			Intermittent	TP	GP91TM	180-250-330	0.30-1.20-2.50	0.05-0.15-0.28	
					GP31TM	180-250-330	0.50-1.00-3.00	0.10-0.15-0.35	
					GP91TM	180-230-310	0.50-1.20-3.00	0.10-0.20-0.35	
			Rough Finishing	Continuous	QR	GPT6110	140-210-270	1.50-3.50-6.00	0.20-0.30-0.60
						GP1105	120-180-260	1.50-3.50-6.00	0.20-0.30-0.60
						GP1115	110-170-240	1.50-3.50-6.00	0.20-0.30-0.60
						GPT6120	130-200-260	1.50-3.50-6.00	0.20-0.30-0.60
						GP1225	110-160-240	1.50-3.50-6.00	0.20-0.30-0.60
						GPT6130	110-180-240	1.50-3.50-6.00	0.20-0.30-0.60
				General		GP1130	110-160-240	1.50-3.50-6.00	0.20-0.30-0.60
						GP1135	100-140-220	1.50-3.50-6.00	0.20-0.30-0.60
						Intermittent	GPT6110	90-160-220	3.00-6.00-12.0
				GP1105	90-140-230		3.00-6.00-12.0	0.35-0.60-1.10	
				GP1115	80-140-200		3.00-6.00-12.0	0.35-0.60-1.10	
				GPT6120	90-150-210		3.00-6.00-12.0	0.35-0.60-1.10	
			GP1225	80-130-200	3.00-6.00-12.0		0.35-0.60-1.10		
			GPT6130	80-140-200	3.00-6.00-12.0		0.35-0.60-1.10		
			Heavy Machining	Continuous	QH	GP1135	70-120-180	3.00-6.00-12.0	0.35-0.60-1.10
General	Intermittent								

## Recommended Cutting Data (Negative Inserts)

ISO	Workpiece Materials	Hardness	Application Range	Cutting Mode	Chip Breaker	Grade	Min-Optimum-Max				
							Cutting Speed Vc(m/min)	Cutting Depth ap(mm)	Feeding Rate f(mm/rev)		
P	Carbon Steel, Alloy Steel	HB280-350	Finishing Machining	Continuous	QF	GPT6110	180-220-290	0.40-0.80-2.00	0.08-0.15-0.35		
						GP1105	160-200-270	0.40-0.80-2.00	0.08-0.15-0.35		
						GP1115	150-180-250	0.40-0.80-2.00	0.08-0.15-0.35		
				General		GPT6120	150-200-270	0.40-0.80-2.00	0.08-0.15-0.35		
						GP1120	150-180-250	0.40-0.80-2.00	0.08-0.15-0.35		
						GP1225	100-150-220	0.80-2.00-4.00	0.15-0.20-0.40		
				Intermittent		GPT6130	130-170-230	0.40-0.80-2.00	0.08-0.15-0.35		
						GP1130	130-150-230	0.40-0.80-2.00	0.08-0.15-0.35		
						GP1135	110-130-210	0.40-0.80-2.00	0.08-0.15-0.35		
			Continuous	GF	GP1115	150-180-250	0.80-1.20-2.50	0.10-0.20-0.35			
					GP1225	130-150-230	0.80-1.20-2.50	0.10-0.20-0.35			
					GP92TM	150-190-280	0.40-1.00-2.30	0.12-0.20-0.30			
			Semi-finished	Continuous	QM	GPT6110	140-200-270	0.80-2.00-4.00	0.15-0.20-0.40		
						GP1105	120-180-250	0.80-2.00-4.00	0.15-0.20-0.40		
						GP1115	110-170-240	0.80-2.00-4.00	0.15-0.20-0.40		
						GP31TM	180-230-320	0.50-1.20-2.50	0.10-0.18-0.30		
						GP91TM	160-210-300	0.50-1.50-3.00	0.15-0.22-0.35		
						GPT6120	110-190-260	0.80-2.00-4.00	0.15-0.20-0.40		
				General	GP1120	110-170-240	0.80-2.00-4.00	0.15-0.20-0.40			
					GP1225	100-150-220	0.80-2.00-4.00	0.15-0.20-0.40			
					GPT6130	100-170-220	0.80-2.00-4.00	0.15-0.20-0.40			
				Intermittent	GP1130	100-150-220	0.80-2.00-4.00	0.15-0.20-0.40			
					GP1135	900-130-200	0.80-2.00-4.00	0.15-0.20-0.40			
					Continuous	GM	GP1115	110-170-240	1.00-2.00-4.00	0.18-0.22-0.40	
				GP1225			100-150-220	1.00-2.00-4.00	0.18-0.22-0.40		
				GP1225			100-140-220	1.00-2.50-4.50	0.18-0.25-0.45		
				Intermittent	SV	GP1225	100-140-220	1.00-2.50-4.50	0.18-0.25-0.45		
						Continuous	TP	GP31TM	180-250-320	0.30-1.00-2.50	0.05-0.12-0.28
								GP91TM	170-230-300	0.30-1.20-2.50	0.05-0.15-0.28
				Continuous	TS	GP31TM	170-230-300	0.50-1.00-3.00	0.10-0.15-0.35		
			GP91TM			150-210-280	0.50-1.20-3.00	0.10-0.20-0.35			
			Rough Finishing	Continuous	QR	GPT6110	120-190-230	2.00-3.50-6.50	0.20-0.30-0.60		
						GP1105	100-150-210	2.00-3.50-6.50	0.20-0.30-0.60		
						GP1115	90-150-200	2.00-3.50-6.50	0.20-0.30-0.60		
				General		GPT6120	110-180-220	2.00-3.50-6.50	0.20-0.30-0.60		
						GP1225	90-140-200	2.00-3.50-6.50	0.20-0.30-0.60		
						GPT6130	90-160-200	2.00-3.50-6.50	0.20-0.30-0.60		
				Intermittent		GP1130	90-140-200	2.00-3.50-6.50	0.20-0.30-0.60		
						GP1135	80-120-180	2.00-3.50-6.50	0.20-0.30-0.60		
						Continuous	QH	GPT6110	80-130-190	3.00-6.00-12.0	0.35-0.60-1.10
			GP1105	80-110-190	3.00-6.00-12.0			0.35-0.60-1.10			
			GP1115	70-110-170	3.00-6.00-12.0			0.35-0.60-1.10			
General	GPT6120	80-120-180	3.00-6.00-12.0	0.35-0.60-1.10							
	GP1225	70-100-170	3.00-6.00-12.0	0.35-0.60-1.10							
Intermittent	GPT6130	70-110-170	3.00-6.00-12.0	0.35-0.60-1.10							
GP1135	60-90-150	3.00-6.00-12.0	0.35-0.60-1.10								



## Recommended Cutting Data (Negative Inserts)

ISO	Workpiece Materials	Hardness	Application Range	Cutting Mode	Chip Breaker	Grade	Min-Optimum-Max		
							Cutting Speed Vc(m/min)	Cutting Depth ap(mm)	Feeding Rate f(mm/rev)
<b>M</b>	Martensitic Ferrite SUS410 SUS430etc.	≤HB230	Finishing Machining	General	SF	GS3115	120-190-250	0.10-0.80-1.50	0.08-0.10-0.30
				General	YF	GM3220	100-150-200	0.10-0.80-1.50	0.08-0.12-0.25
			Semi-finished	Continuous	SM	GM1115	200-250-300	0.50-1.20-2.00	0.10-0.20-0.40
						GM3215	120-160-200	1.00-2.00-3.00	0.15-0.20-0.30
				General	SM	GM3220	60-130-180	1.00-2.00-3.00	0.15-0.20-0.35
						GM1125	180-230-280	0.50-1.80-3.00	0.10-0.20-0.40
				Intermittent	SM	GM1230	180-230-280	0.50-1.80-3.00	0.10-0.20-0.40
						GM3225	60-130-180	1.00-2.00-3.00	0.15-0.20-0.35
				Continuous	LM	GM1115	200-250-300	0.80-1.80-3.50	0.08-0.18-0.40
						GM3215	120-160-200	0.80-1.80-3.50	0.08-0.18-0.30
			General	LM	GM3220	60-130-180	0.80-1.80-3.50	0.08-0.20-0.40	
					GM1125	180-230-280	0.80-1.80-3.50	0.08-0.18-0.40	
			Intermittent	LM	GM1230	180-230-280	0.80-1.80-3.50	0.08-0.18-0.40	
					GM3225	60-130-180	0.80-1.80-3.50	0.08-0.20-0.40	
			Rough Finishing	LR	Continuous	GM1115	200-250-300	1.50-3.00-5.00	0.15-0.30-0.50
					General	GM3220	60-130-180	1.50-3.00-5.00	0.15-0.30-0.50
					Intermittent	GM3225	60-130-180	1.50-3.00-5.00	0.15-0.30-0.50
			Austenite SUS201 SUS304 SUS316etc.	≤HB250	Finishing Machining	General	SF	GS3115	120-190-250
	General	YF				GM3220	80-130-180	0.10-0.80-1.50	0.08-0.12-0.25
	Semi-finished	Continuous			SM	GM1115	180-230-280	0.50-1.20-2.00	0.10-0.20-0.40
						GM3215	100-130-160	1.00-2.00-3.00	0.15-0.20-0.30
		General			SM	GM3220	60-110-150	1.00-2.00-3.00	0.15-0.20-0.35
						GM1125	180-230-280	0.50-1.80-3.00	0.10-0.20-0.40
		Intermittent			SM	GM1230	180-230-280	0.50-1.80-3.00	0.10-0.20-0.40
GM3225						60-110-150	1.00-2.00-3.00	0.15-0.20-0.35	
Continuous		LM			GM1115	200-250-300	0.80-1.80-3.50	0.08-0.18-0.40	
					GM3215	100-130-160	0.80-1.80-3.50	0.08-0.18-0.30	
General	LM	GM3220			60-110-150	0.80-1.80-3.50	0.08-0.20-0.40		
		GM1125			160-200-240	0.80-1.80-3.50	0.08-0.18-0.40		
Intermittent	LM	GM1230			160-200-240	0.80-1.80-3.50	0.08-0.18-0.40		
		GM3225			60-110-150	0.80-1.80-3.50	0.08-0.20-0.40		
Rough Finishing	LR	Continuous			GM1115	180-230-280	1.50-3.00-5.00	0.15-0.30-0.50	
		General			GM3220	60-110-150	1.50-3.00-5.00	0.15-0.30-0.50	
		Intermittent	GM3225	60-110-150	1.50-3.00-5.00	0.15-0.30-0.50			

## Recommended Cutting Data (Negative Inserts)

ISO	Workpiece Materials	Hardness	Application Range	Cutting Mode	Chip Breaker	Grade	Min-Optimum-Max		
							Cutting Speed Vc(m/min)	Cutting Depth ap(mm)	Feeding Rate f(mm/rev)
<b>K</b>	Ferrosteel FC200 FC250 FC300etc.	≤HB220	Semi-finished	Continuous	WMV	GK1115	230-350-500	1.00-2.00-6.00	0.20-0.40-0.80
				Intermittent		GK1125	220-320-480	1.00-2.00-6.00	0.20-0.40-0.80
				Continuous	MK	GK1115	230-350-500	0.50-1.50-3.00	0.10-0.20-0.40
				General		GK1120	230-320-500	0.50-1.50-3.00	0.10-0.20-0.40
				Intermittent		GK1125	220-320-480	0.50-1.50-3.00	0.10-0.20-0.40
				Continuous	UK	GK1115	230-350-500	0.50-1.50-3.00	0.10-0.20-0.40
				General		GK1120	230-320-500	0.50-1.50-3.00	0.10-0.20-0.40
				Intermittent		GK1125	220-320-480	0.50-1.50-3.00	0.10-0.20-0.40
				Rough Finishing	Continuous	HK	GK1115	220-320-480	0.50-2.00-4.00
			General		GK1120		220-300-480	0.50-2.00-4.00	0.10-0.25-0.50
			Intermittent		GK1125		210-300-450	0.50-2.00-4.00	0.10-0.25-0.50
			Heavy Machining	Continuous	Flat	GK1115	210-300-450	1.00-2.50-6.00	0.20-0.30-0.60
				General		GK1120	210-280-450	1.00-2.50-6.00	0.20-0.30-0.60
				Intermittent		GK1125	200-280-430	1.00-2.50-6.00	0.20-0.30-0.60
			Nodular Cast Iron FCD450 FCD500 FCD600etc.	≤HB300	Semi-finished	Continuous	WMV	GK1115	180-260-380
	Intermittent	GK1125				160-230-350		1.00-2.00-6.00	0.20-0.40-0.80
	Continuous	MK				GK1115	180-260-380	0.50-1.50-3.00	0.10-0.20-0.40
	General					GK1120	180-260-380	0.50-1.50-3.00	0.10-0.20-0.40
	Intermittent					GK1125	160-230-350	0.50-1.50-3.00	0.10-0.20-0.40
	Continuous	UK				GK1115	180-260-380	0.50-1.50-3.00	0.10-0.20-0.40
	General					GK1120	180-260-380	0.50-1.50-3.00	0.10-0.20-0.40
	Intermittent					GK1125	160-230-350	0.50-1.50-3.00	0.10-0.20-0.40
	Rough Finishing	Continuous				HK	GK1115	180-240-360	0.50-2.00-4.00
		General			GK1120		180-240-360	0.50-2.00-4.00	0.10-0.25-0.50
Intermittent		GK1125			160-230-350		0.50-2.00-4.00	0.10-0.25-0.50	
Heavy Machining	Continuous	无			GK1115	180-220-350	1.00-2.50-6.00	0.20-0.30-0.60	
	General				GK1120	180-220-350	1.00-2.50-6.00	0.20-0.30-0.60	
	Intermittent				GK1125	160-230-350	1.00-2.50-6.00	0.20-0.30-0.60	
<b>S</b>	super alloy Titanium Alloy	≤HRC45			Finishing to Semi-Finishing	EL	GST7115	20-40-70	0.50-1.50-3.00
			General	GST7120			20-40-70	0.50-1.50-3.00	0.10-0.15-0.22
			Intermittent	GST7125			20-30-40	0.50-1.50-3.00	0.10-0.15-0.22
			SML	Continuous		GST7115	20-40-70	0.50-1.50-3.00	0.10-0.20-0.30
				General		GST7120	20-40-70	0.50-1.50-3.00	0.10-0.20-0.30
				Intermittent		GST7125	20-30-40	0.50-1.50-3.00	0.10-0.20-0.30
			Semi-finished	EM	Continuous	GST7115	20-40-70	1.00-2.50-4.00	0.10-0.20-0.35
					General	GST7120	20-40-70	1.00-2.50-4.00	0.10-0.20-0.35
					Intermittent	GST7125	20-30-40	1.00-2.50-4.00	0.10-0.20-0.35
				SMM	Continuous	GST7115	20-40-70	1.00-2.50-4.00	0.10-0.25-0.40
					General	GST7120	20-40-70	1.00-2.50-4.00	0.10-0.25-0.40
					Intermittent	GST7125	20-30-40	1.00-2.50-4.00	0.10-0.25-0.40

## Recommended Cutting Data (Positive Inserts)

ISO	Workpiece Materials	Hardness	Application Range	Cutting Mode	Chip Breaker	Grade	Min-Optimum-Max		
							Cutting Speed Vc(m/min)	Cutting Depth ap(mm)	Feeding Rate f(mm/rev)
<b>P</b>	Mild Steel	≤HB180	Finishing Machining	Continuous	MM	GP31TM	220-280-340	0.10-0.50-1.00	0.03-0.10-0.20
						GP91TM	200-250-310	0.10-0.60-1.50	0.03-0.12-0.20
				GPT6110		210-260-340	0.10-0.60-1.50	0.05-0.10-0.20	
				GPT6120		180-240-320	0.10-0.60-1.50	0.05-0.10-0.20	
				GPT6130		170-220-280	0.10-0.60-1.50	0.05-0.10-0.20	
			Continuous	SPL	GP92TM	180-240-300	0.30-0.80-2.00	0.07-0.12-0.26	
			Semi-Finishing to Rough-Finish	Continuous	GP	GP31TM	200-250-300	0.30-0.80-1.50	0.05-0.12-0.22
						GP91TM	180-230-300	0.30-1.00-1.80	0.05-0.15-0.22
				GP1115		170-200-280	0.40-1.00-2.50	0.07-0.12-0.30	
				GP1120		170-200-280	0.40-1.00-2.50	0.07-0.12-0.30	
				GP1225		150-180-260	0.40-1.00-2.50	0.07-0.12-0.30	
			Intermittent	GP1130	150-180-260	0.40-1.00-2.50	0.07-0.12-0.30		
			Semi-finished	Continuous	TP	GP31TM	200-250-300	0.30-1.00-3.00	0.05-0.12-0.25
						GP91TM	180-230-300	0.30-1.20-3.00	0.05-0.15-0.25
	Carbon Steel, Alloy Steel	HB180-280	Finishing Machining	Continuous	MM	GP31TM	200-250-330	0.10-0.50-1.00	0.03-0.10-0.20
						GP91TM	180-230-300	0.10-0.60-1.50	0.03-0.12-0.20
				GPT6110		180-220-290	0.10-0.60-1.50	0.05-0.10-0.20	
				GPT6120		150-200-280	0.10-0.60-1.50	0.05-0.10-0.20	
				GPT6130		140-180-240	0.10-0.60-1.50	0.05-0.10-0.20	
			Continuous	SPL	GP92TM	160-210-290	0.30-0.80-2.00	0.07-0.12-0.26	
			Semi-Finishing to Rough-Finish	Continuous	GP	GP31TM	180-210-280	0.30-0.80-1.50	0.05-0.12-0.22
						GP91TM	160-190-270	0.30-1.00-1.80	0.05-0.15-0.22
				GP1115		140-160-240	0.40-1.00-2.50	0.07-0.12-0.30	
				GP1120		140-160-240	0.40-1.00-2.50	0.07-0.12-0.30	
				GP1225		120-140-220	0.40-1.00-2.50	0.07-0.12-0.30	
			Intermittent	GP1130	120-140-220	0.40-1.00-2.50	0.07-0.12-0.30		
			Semi-finished	Continuous	TP	GP31TM	180-210-280	0.30-1.00-3.00	0.05-0.12-0.25
						GP91TM	160-190-270	0.30-1.20-3.00	0.05-0.15-0.25
HB280-350		Finishing Machining	Continuous	MM	GP31TM	160-220-300	0.10-0.50-1.00	0.03-0.10-0.20	
					GP91TM	140-200-280	0.10-0.60-1.50	0.03-0.12-0.20	
			GPT6110		160-200-260	0.10-0.60-1.50	0.05-0.10-0.20		
			GPT6120		130-180-250	0.10-0.60-1.50	0.05-0.10-0.20		
			GPT6130		120-160-210	0.10-0.60-1.50	0.05-0.10-0.20		
		Continuous	SPL	GP92TM	150-190-280	0.30-0.80-2.00	0.07-0.12-0.26		
		Semi-Finishing to Rough-Finish	Continuous	GP	GP31TM	160-200-270	0.30-0.80-1.50	0.05-0.12-0.22	
					GP91TM	130-160-250	0.30-1.00-1.80	0.05-0.15-0.22	
			GP1115		120-160-210	0.40-1.00-2.50	0.07-0.12-0.30		
			GP1120		120-160-210	0.40-1.00-2.50	0.07-0.12-0.30		
			GP1225		100-140-220	0.40-1.00-2.50	0.07-0.12-0.30		
		Intermittent	GP1130	100-140-220	0.40-1.00-2.50	0.07-0.12-0.30			
		Semi-finished	Continuous	TP	GP31TM	160-200-270	0.30-1.00-3.00	0.05-0.12-0.25	
					GP91TM	130-160-250	0.30-1.20-3.00	0.05-0.15-0.25	

## Recommended Cutting Data (Positive Inserts)

ISO	Workpiece Materials	Hardness	Application Range	Cutting Mode	Chip Breaker	Grade	Min-Optimum-Max		
							Cutting Speed Vc(m/min)	Cutting Depth ap(mm)	Feeding Rate f(mm/rev)
<b>M</b>	Martensitic Ferrite SUS410 SUS430	≤HB300	Finishing to Semi-Finishing	Continuous	MM	GM1115	200-250-300	0.50-0.70-1.50	0.05-0.10-0.20
				General		GM3220	40-80-140	0.50-0.70-1.50	0.05-0.10-0.20
				Intermittent		GM3225	40-80-140	0.50-0.70-1.50	0.05-0.10-0.20
			Semi-Finishing to Rough-Finish	GP	Continuous	GM1115	150-200-250	0.40-1.00-2.50	0.07-0.12-0.30
					General	GM3215	60-100-160	0.40-1.00-2.50	0.07-0.12-0.25
					Intermittent	GM3220	40-80-140	0.40-1.00-2.50	0.07-0.12-0.30
						GM1125	120-150-180	0.40-1.00-2.50	0.07-0.12-0.30
						GM1230	120-150-180	0.40-1.00-2.50	0.07-0.12-0.30
	GM3225	40-80-140	0.40-1.00-2.50	0.07-0.12-0.30					
	Austenite SUS201 SUS304 SUS316	≤HB250	Finishing to Semi-Finishing	Continuous	MM	GM1115	200-240-300	0.50-0.70-1.50	0.05-0.10-0.20
				General		GM3220	40-70-140	0.50-0.70-1.50	0.05-0.10-0.20
				Intermittent		GM3225	40-70-140	0.50-0.70-1.50	0.05-0.10-0.20
			Semi-Finishing to Rough-Finish	GP	Continuous	GM1115	150-190-250	0.40-1.00-2.50	0.07-0.12-0.30
					General	GM3215	50-90-150	0.40-1.00-2.50	0.07-0.12-0.25
Intermittent					GM3220	40-70-140	0.40-1.00-2.50	0.07-0.12-0.30	
					GM1125	120-140-180	0.40-1.00-2.50	0.07-0.12-0.30	
					GM1230	120-140-180	0.40-1.00-2.50	0.07-0.12-0.30	
GM3225	40-70-140	0.40-1.00-2.50	0.07-0.12-0.30						
<b>K</b>	Ferrosteel FC200 FC250 FC300etc.	≤HB250	Finishing to Semi-Finishing	Continuous	GP	GK1115	180-280-380	0.30-0.80-2.00	0.05-0.12-0.25
				General		GK1120	180-260-380	0.30-0.80-2.00	0.05-0.12-0.25
				Intermittent		GK1125	160-250-350	0.30-0.80-2.00	0.05-0.12-0.25
			Semi-Finishing to Rough-Finish	KM	Continuous	GK1115	180-260-360	1.00-2.00-4.00	0.13-0.20-0.40
					General	GK1120	180-240-360	1.00-2.00-4.00	0.13-0.20-0.40
					Intermittent	GK1125	160-230-340	1.00-2.00-4.00	0.13-0.20-0.40
	Nodular Cast Iron FCD450 FCD500 FCD600etc.	≤HB270	Finishing to Semi-Finishing	Continuous	GP	GK1115	160-250-350	0.30-0.80-2.00	0.05-0.12-0.25
				General		GK1120	160-220-350	0.30-0.80-2.00	0.05-0.12-0.25
				Intermittent		GK1125	140-230-330	0.30-0.80-2.00	0.05-0.12-0.25
			Semi-Finishing to Rough-Finish	KM	Continuous	GK1115	160-230-330	1.00-2.00-4.00	0.13-0.20-0.40
					General	GK1120	160-200-330	1.00-2.00-4.00	0.13-0.20-0.40
					Intermittent	GK1125	140-200-310	1.00-2.00-4.00	0.13-0.20-0.40
<b>N</b>	Aluminum	Harden HB90-100	Finishing to Semi-Finishing	General	AL	GN9110	250-700-970	0.50-1.20-3.00	0.05-0.10-0.30
		Untreated HB60-90				GN9120	250-680-960	0.50-1.20-3.50	0.05-0.10-0.30
						GN9130	250-650-950	0.50-1.20-4.00	0.05-0.10-0.30
						GNT7120	950-1300-2000	0.50-1.20-3.50	0.05-0.10-0.30



C



# SMALL PART TURNING

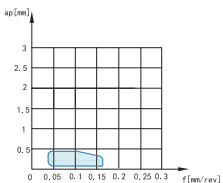
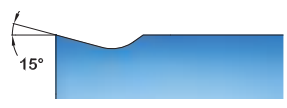
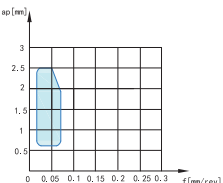
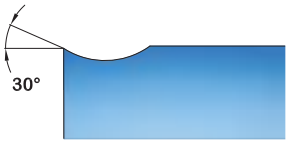
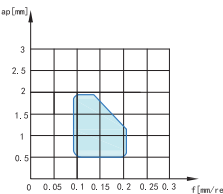
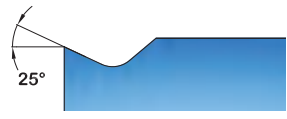
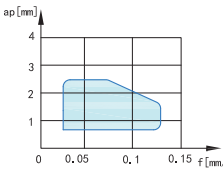

# Overview of Small Part Turning Inserts

## Small Part Turning Inserts (Negative)

Chip Breaker	Features	Application Range	Cross Section Chip Breaker
P	<ul style="list-style-type: none"> <li>The chute design stably controls the chip removal direction.</li> <li>No flute width design, sharpen cutting edge, effectively reducing cutting force.</li> </ul>		
G	<ul style="list-style-type: none"> <li>Arc groove design improves the sharpness of the edge while ensuring Tip strength.</li> <li>Large flute length design, satisfying large depth of cut.</li> </ul>		
S	<ul style="list-style-type: none"> <li>Edge inclination design, control chip flow direction, reduce cutting resistance force.</li> <li>No flute width design, sharp cutting edge, effectively reducing cutting force.</li> </ul>		
AK	<ul style="list-style-type: none"> <li>The sharp edge design meets the requirements of surface machining.</li> <li>Edge inclination design, control cutting chip direction, reduce cutting resistance.</li> </ul>		

	80°Rhombic	55°Rhombic	90°Square	60°Regular Triangle	35°Rhombic	80°Trigon
						
				TNGG-P		
				P088		
						
				TNGG-G		
				P088		
						
				TNGG-S		
				P088		
						
				TNGG-AK		
				P088		

# Overview of Small Part Turning Inserts

## Small Part Turning Inserts (Positive)

5° Clearance Angle

Chip Breaker	Features	Application Range	Cross Section Chip Breaker
P	<ul style="list-style-type: none"> <li>The chute design stably controls the chip removal direction.</li> <li>No flute width design, sharpen cutting edge, effectively reducing cutting force.</li> </ul>		
G	<ul style="list-style-type: none"> <li>Arc groove design improves the sharpness of the edge while ensuring Tip strength.</li> <li>Large flute length design, satisfying large depth of cut.</li> </ul>		
S	<ul style="list-style-type: none"> <li>Edge inclination design, control chip flow direction, reduce cutting resistance force.</li> <li>No flute width design, sharp cutting edge, effectively reducing cutting force.</li> </ul>		
AF	<ul style="list-style-type: none"> <li>The small groove width design meets the chip breaking requirements in the field of small depth of cut.</li> <li>Large rake angle design reduces cutting resistance and obtains excellent processed surface quality.</li> </ul>		
BF	<ul style="list-style-type: none"> <li>Special design of chip breaker promotes chip curling and facilitates chip removal</li> <li>Small rake angle design, high tip strength and strong versatility.</li> </ul>		
BK	<ul style="list-style-type: none"> <li>Large groove width design, enhance chip removal and achieve stable machining.</li> <li>Inclination angle design to control chip flow direction and reduce cutting resistance force.</li> </ul>		
MM	<ul style="list-style-type: none"> <li>Double front angle design, taking into account sharpness and strength, wide processing range.</li> <li>Hyperboloid chip breaker design promotes stable chip rolling and breaking Chips, dramatically improve chip removal.</li> </ul>		















	80°Rhombic	55°Rhombic	90°Square	60°Regular Triangle	35°Rhombic	80°Trigon
						
				TBGT-P P096	VBGT-P P098	WBGT-P P103
						
					VBGT-G P098	
						
					VBGT-S P099	
						
					VBGT-AF P099	
						
					VBGT-BF P099	
						
					VBGT-BK P099	
						
					VBGT-MM P099	

# Overview of Small Part Turning Inserts

## Small Part Turning Inserts (Positive)

7° Clearance Angle

Chip Breaker	Features	Application Range	Cross Section Chip Breaker
P	<ul style="list-style-type: none"> <li>The chute design stably controls the chip removal direction.</li> <li>No flute width design, sharpen cutting edge, effectively reducing cutting force.</li> </ul>		
G	<ul style="list-style-type: none"> <li>Arc groove design improves the sharpness of the edge while ensuring Tip strength.</li> <li>Large flute length design, satisfying large depth of cut.</li> </ul>		
S	<ul style="list-style-type: none"> <li>Edge inclination design, control chip flow direction, reduce cutting resistance force.</li> <li>No flute width design, sharp cutting edge, effectively reducing cutting force.</li> </ul>		
AF	<ul style="list-style-type: none"> <li>The small groove width design meets the chip breaking requirements in the field of small depth of cut.</li> <li>Large rake angle design reduces cutting resistance and obtains excellent processed surface quality.</li> </ul>		
AK	<ul style="list-style-type: none"> <li>The sharp edge design meets the requirements of surface machining.</li> <li>Edge inclination design, control cutting chip direction, reduce cutting resistance.</li> </ul>		









	80°Rhombic	55°Rhombic	90°Square	60°Regular Triangle	35°Rhombic	80°Trigon
						
	CCGT-P P089	DCGT-P P093		TCGT-P P096	VCGT-P P100	
						
	CCGT-G P090	DCGT-G P094		TCGT-G P096	VCGT-G P100	
						
		DCGT-S P094			VCGT-S P100	
						
		DCGT-AF P095			VCGT-AF P101	
						
		DCGT-AK P095				

# Overview of Small Part Turning Inserts

## Small Part Turning Inserts (Positive)

7° Clearance Angle





Chip Breaker	Features	Application Range	Cross Section Chip Breaker
BF	<ul style="list-style-type: none"> <li>• Special design of chip breaker promotes chip curling and facilitates chip removal</li> <li>• Small rake angle design, high tip strength and strong versatility.</li> </ul>		
BK	<ul style="list-style-type: none"> <li>• Large groove width design, enhance chip removal and achieve stable machining.</li> <li>• Inclination angle design to control chip flow direction and reduce cutting resistance force.</li> </ul>		
MM	<ul style="list-style-type: none"> <li>• Double front angle design, taking into account sharpness and strength, wide processing range.</li> <li>• Hyperboloid chip breaker design promotes stable chip rolling and breaking Chips, dramatically improve chip removal.</li> </ul>		

	80°Rhombic	55°Rhombic	90°Square	60°Regular Triangle	35°Rhombic	80°Trigon
						
	CCGT-BF P092	DCGT-BF P095			VCGT-BF P101	
						
	CCGT-BK P092	DCGT-BK P095			VCGT-BK P101	
						
		DCGT-MM P095			VCGT-MM P101	

## Overview of Small Part Turning Inserts

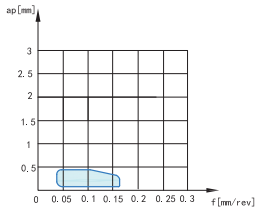
### Small Part Turning Inserts (Positive)

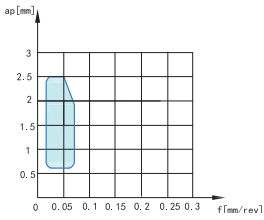
11° Clearance Angle

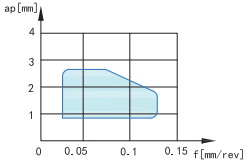
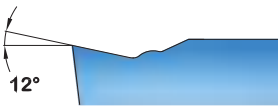
Chip Breaker	Features	Application Range	Cross Section Chip Breaker
P	<ul style="list-style-type: none"> <li>The chute design stably controls the chip removal direction.</li> <li>No flute width design, sharpen cutting edge, effectively reducing cutting force.</li> </ul>		
G	<ul style="list-style-type: none"> <li>Arc groove design improves the sharpness of the edge while ensuring Tip strength.</li> <li>Large flute length design, satisfying large depth of cut.</li> </ul>		
BK	<ul style="list-style-type: none"> <li>Large groove width design, enhance chip removal and achieve stable machining.</li> <li>Inclination angle design to control chip flow direction and reduce cutting resistance force.</li> </ul>		

	80°Rhombic	55°Rhombic	90°Square	60°Regular Triangle	35°Rhombic	80°Trigon
						
				TPGT(H)-P P097	VPGT-P P102	
						
				TPGT-G P097	VPGT-G P102	
						
					VPGT-BK P102	

## Overview of Small Part Turning Inserts

### Small Part Turning Inserts (Others)

#### Back Turning

Chip Breaker	Features	Application Range	Cross Section Chip Breaker
GSAB	<ul style="list-style-type: none"> <li>•Special shape design to meet the requirements of back turning processing.</li> <li>•Special flute design, stable control of chip flow.</li> </ul>		
GSTB	<ul style="list-style-type: none"> <li>•Vertical structure design, firm clamping, stable cutting.</li> <li>•The chute design can effectively control the direction of chip removal.</li> </ul>		

#### Schematic diagram of tool processing for small parts

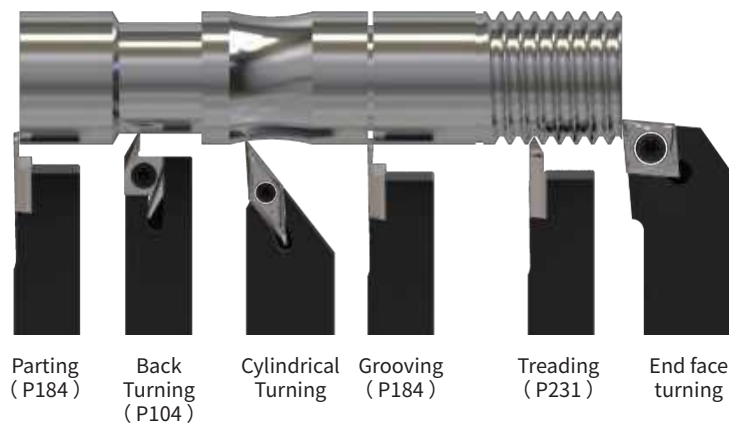



Appearance	
	
	GSAB P104
	
	GSTB P105

Three-dimensional parting groove and general groove Code Identification System

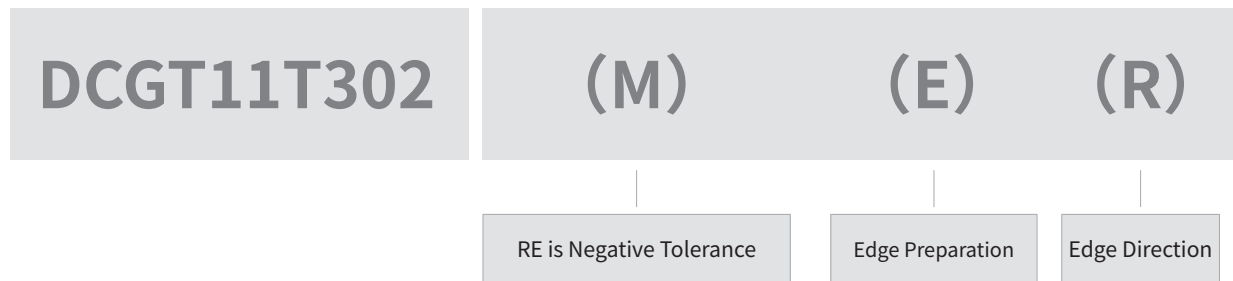



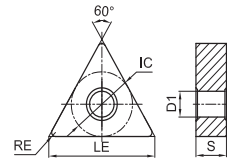

Small Part Turning Inserts (Negative)

**TN** □ □

Triangle 60° with hole



Ordering Code	Dimension (mm)					Coated Carbides			
	LE	IC	S	D1	RE	GAT7115	GAT7120	GAT7120A	GAT7125
 TNGG160401L-P	16.5	9.525	4.76	3.81	0.1	●	●		●
TNGG160401R-P	16.5	9.525	4.76	3.81	0.1	●	●		●
TNGG160402L-P	16.5	9.525	4.76	3.81	0.2	●	●		●
TNGG160402R-P	16.5	9.525	4.76	3.81	0.2	●	●		●
TNGG160404L-P	16.5	9.525	4.76	3.81	0.4	●	●		●
TNGG160404R-P	16.5	9.525	4.76	3.81	0.4	●	●		●
TNGG160408L-P	16.5	9.525	4.76	3.81	0.8	○	●		○
TNGG160408R-P	16.5	9.525	4.76	3.81	0.8	○	○		○
 TNGG160404L-G	16.5	9.525	4.76	3.81	0.4		●		
TNGG160404R-G	16.5	9.525	4.76	3.81	0.4		●		
TNGG160408L-G	16.5	9.525	4.76	3.81	0.8		●		
TNGG160408R-G	16.5	9.525	4.76	3.81	0.8		●		
 TNGG160404R-S	16.5	9.525	4.76	3.81	0.4	○			
 TNGG160401M-AK	16.5	9.525	4.76	3.81	<0.1	●			●
TNGG160402M-AK	16.5	9.525	4.76	3.81	<0.2	●		○	●
TNGG160404M-AK	16.5	9.525	4.76	3.81	<0.4	●			●

● Stock ○ Available Upon Order

Small Part Turning Inserts (Positive)



Rhombic 80° with hole

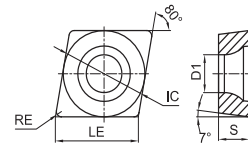

Ordering Code	Dimension (mm)					Coated Carbides			
	LE	IC	S	D1	RE	GAT7115	GAT7120	GAT7120A	GAT7125
CCGT0301005ML-P	4.0	3.5	1.4	1.9	<0.05	○	○		○
CCGT0301005MR-P	4.0	3.5	1.4	1.9	<0.05	○	○		○
CCGT030101ML-P	4.0	3.5	1.4	1.9	<0.1	●	○		○
CCGT030101MR-P	4.0	3.5	1.4	1.9	<0.1	○	○		○
CCGT030102ML-P	4.0	3.5	1.4	1.9	<0.2	●	○		●
CCGT030102MR-P	4.0	3.5	1.4	1.9	<0.2	○	○		○
CCGT030104ML-P	4.0	3.5	1.4	1.9	<0.4	●	○		●
CCGT030104MR-P	4.0	3.5	1.4	1.9	<0.4	○	○		○
CCGT0401005ML-P	4.8	4.3	1.8	2.3	<0.05	○	○		○
CCGT0401005MR-P	4.8	4.3	1.8	2.3	<0.05	○	○		○
CCGT040101ML-P	4.8	4.3	1.8	2.3	<0.1	○	○		○
CCGT040101MR-P	4.8	4.3	1.8	2.3	<0.1	○	○		○
CCGT040102ML-P	4.8	4.3	1.8	2.3	<0.2	●	○		●
CCGT040102MR-P	4.8	4.3	1.8	2.3	<0.2	●	○		○
CCGT040104ML-P	4.8	4.3	1.8	2.3	<0.4	●	○		●
CCGT040104MR-P	4.8	4.3	1.8	2.3	<0.4	●	○		○
CCGT0602005ML-P	6.5	6.35	2.38	2.8	<0.05	○	○		○
CCGT0602005MR-P	6.5	6.35	2.38	2.8	<0.05	○	●		○
CCGT060201ML-P	6.5	6.35	2.38	2.8	<0.1	●	○		●
CCGT060201MR-P	6.5	6.35	2.38	2.8	<0.1	○	●		○
CCGT09T3005ML-P	9.7	9.525	3.97	4.4	<0.05	○	○		○
CCGT09T3005MR-P	9.7	9.525	3.97	4.4	<0.05	○	●		○
CCGT09T301ML-P	9.7	9.525	3.97	4.4	<0.1	○	○		○
CCGT09T301MR-P	9.7	9.525	3.97	4.4	<0.1	○	○		○
CCGT030101L-P	4.0	3.5	1.4	1.9	0.1		●		
CCGT030102L-P	4.0	3.5	1.4	1.9	0.2		●		
CCGT030104L-P	4.0	3.5	1.4	1.9	0.4		●		
CCGT040101L-P	4.8	4.3	1.8	2.3	0.1		●		
CCGT040102L-P	4.8	4.3	1.8	2.3	0.2		●		
CCGT040104L-P	4.8	4.3	1.8	2.3	0.4		●		
CCGT060201L-P	6.5	6.35	2.38	2.8	0.1		○		
CCGT060201R-P	6.5	6.35	2.38	2.8	0.1		○		



●Stock ○Available Upon Order

Small Part Turning Inserts (Positive)



Rhombic 80° with hole

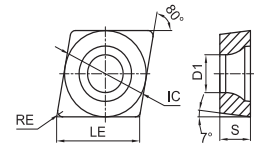

Ordering Code	Dimension (mm)					Coated Carbides			
	LE	IC	S	D1	RE	GAT7115	GAT7120	GAT7120A	GAT7125
CCGT060202L-P	6.5	6.35	2.38	2.8	0.2		●		
CCGT060202R-P	6.5	6.35	2.38	2.8	0.2		●		
CCGT060204L-P	6.5	6.35	2.38	2.8	0.4		●		
CCGT060204R-P	6.5	6.35	2.38	2.8	0.4		●		
CCGT09T301L-P	9.7	9.525	3.97	4.4	0.1		○		
CCGT09T301R-P	9.7	9.525	3.97	4.4	0.1		●		
CCGT09T302L-P	9.7	9.525	3.97	4.4	0.2		○		
CCGT09T302R-P	9.7	9.525	3.97	4.4	0.2		●		
CCGT09T304L-P	9.7	9.525	3.97	4.4	0.4		●		
CCGT09T304R-P	9.7	9.525	3.97	4.4	0.4		●		
CCGT0602005ML-G	6.5	6.35	2.38	2.8	<0.05	○	○		○
CCGT0602005MR-G	6.5	6.35	2.38	2.8	<0.05	○	○		○
CCGT060201MEL-G	6.5	6.35	2.38	2.8	<0.1	○	○		○
CCGT060201MER-G	6.5	6.35	2.38	2.8	<0.1	○	○		○
CCGT060201ML-G	6.5	6.35	2.38	2.8	<0.1	●	○		○
CCGT060201MR-G	6.5	6.35	2.38	2.8	<0.1	●	○		○
CCGT060202ML-G	6.5	6.35	2.38	2.8	<0.2	●	○		○
CCGT060202MR-G	6.5	6.35	2.38	2.8	<0.2	●	○		○
CCGT09T3005ML-G	9.7	9.525	3.97	4.4	<0.05	●	○		○
CCGT09T3005MR-G	9.7	9.525	3.97	4.4	<0.05	●	●		○
CCGT09T301MEL-G	9.7	9.525	3.97	4.4	<0.1	○	○		○
CCGT09T301MER-G	9.7	9.525	3.97	4.4	<0.1	○	○		○
CCGT09T301ML-G	9.7	9.525	3.97	4.4	<0.1	●	○		○
CCGT09T301MR-G	9.7	9.525	3.97	4.4	<0.1	●	●		●
CCGT09T302ML-G	9.7	9.525	3.97	4.4	<0.2	●	○		○
CCGT09T302MR-G	9.7	9.525	3.97	4.4	<0.2	●	○		●

●Stock ○Available Upon Order

Small Part Turning Inserts (Positive)



Rhombic 80° with hole

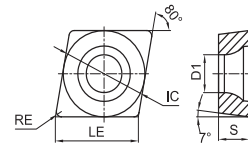

Ordering Code	Dimension (mm)					Coated Carbides			
	LE	IC	S	D1	RE	GAT7115	GAT7120	GAT7120A	GAT7125
CCGT060201EL-G	6.5	6.35	2.38	2.8	0.1		○		
CCGT060201ER-G	6.5	6.35	2.38	2.8	0.1		○		
CCGT060201L-G	6.5	6.35	2.38	2.8	0.1		○		
CCGT060201R-G	6.5	6.35	2.38	2.8	0.1		○		
CCGT060202EL-G	6.5	6.35	2.38	2.8	0.2		●		
CCGT060202ER-G	6.5	6.35	2.38	2.8	0.2		●		
CCGT060202L-G	6.5	6.35	2.38	2.8	0.2		●		
CCGT060202R-G	6.5	6.35	2.38	2.8	0.2		●		
CCGT060204EL-G	6.5	6.35	2.38	2.8	0.4		●		
CCGT060204ER-G	6.5	6.35	2.38	2.8	0.4		●		
CCGT060204L-G	6.5	6.35	2.38	2.8	0.4		○		
CCGT060204R-G	6.5	6.35	2.38	2.8	0.4		○		
CCGT09T301EL-G	9.7	9.525	3.97	4.4	0.1		●		
CCGT09T301ER-G	9.7	9.525	3.97	4.4	0.1		●		
CCGT09T301L-G	9.7	9.525	3.97	4.4	0.1		●		
CCGT09T301R-G	9.7	9.525	3.97	4.4	0.1		●		
CCGT09T302EL-G	9.7	9.525	3.97	4.4	0.2		●		
CCGT09T302ER-G	9.7	9.525	3.97	4.4	0.2		●		
CCGT09T302L-G	9.7	9.525	3.97	4.4	0.2		●		
CCGT09T302R-G	9.7	9.525	3.97	4.4	0.2		●		
CCGT09T304EL-G	9.7	9.525	3.97	4.4	0.4		●		
CCGT09T304ER-G	9.7	9.525	3.97	4.4	0.4		●		
CCGT09T304L-G	9.7	9.525	3.97	4.4	0.4		●		
CCGT09T304R-G	9.7	9.525	3.97	4.4	0.4		○		





● Stock ○ Available Upon Order

Small Part Turning Inserts (Positive)

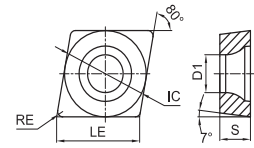

Rhombic 80° with hole



Ordering Code	Dimension (mm)					Coated Carbides			
	LE	IC	S	D1	RE	GAT7115	GAT7120	GAT7120A	GAT7125
 CCGT0602005M-BF	6.5	6.35	2.38	2.8	<0.05	○			
CCGT060201M-BF	6.5	6.35	2.38	2.8	<0.1	●			●
CCGT060202M-BF	6.5	6.35	2.38	2.8	<0.2	●			●
CCGT09T301M-BF	9.7	9.525	3.97	4.4	<0.1	●		○	●
CCGT09T302M-BF	9.7	9.525	3.97	4.4	<0.2	●		○	●
CCGT09T304M-BF	9.7	9.525	3.97	4.4	<0.4	●			●
 CCGT060201M-BK	6.5	6.35	2.38	2.8	<0.1	●			●
CCGT060202M-BK	6.5	6.35	2.38	2.8	<0.2	●			●
CCGT09T301M-BK	9.7	9.525	3.97	4.4	<0.1	●		○	●
CCGT09T302M-BK	9.7	9.525	3.97	4.4	<0.2	●		○	●
CCGT09T304M-BK	9.7	9.525	3.97	4.4	<0.4	●			●

● Stock ○ Available Upon Order

Small Part Turning Inserts (Positive)

**DC** □ □

Rhombic 55° with hole

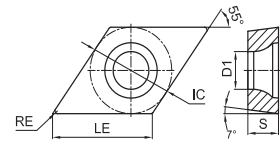

Ordering Code	Dimension (mm)					Coated Carbides			
	LE	IC	S	D1	RE	GAT7115	GAT7120	GAT7120A	GAT7125
DCGT0702005ML-P	7.8	6.35	2.38	2.8	<0.05	○	○		○
DCGT0702005MR-P	7.8	6.35	2.38	2.8	<0.05	○	●		○
DCGT070201ML-P	7.8	6.35	2.38	2.8	<0.1	○	○		○
DCGT070201MR-P	7.8	6.35	2.38	2.8	<0.1	○			○
DCGT070202MR-P	7.8	6.35	2.38	2.8	<0.2				○
DCGT11T3005ML-P	11.6	9.525	3.97	4.4	<0.05	○	○		○
DCGT11T3005MR-P	11.6	9.525	3.97	4.4	<0.05	○	●		○
DCGT11T302MR-P	11.6	9.525	3.97	4.4	<0.2	●	○		●
DCGT0702003L-P	7.8	6.35	2.38	2.8	0.03		○		
DCGT0702003R-P	7.8	6.35	2.38	2.8	0.03		○		
DCGT070201L-P	7.8	6.35	2.38	2.8	0.1		○		
DCGT070201R-P	7.8	6.35	2.38	2.8	0.1		●		
DCGT070202L-P	7.8	6.35	2.38	2.8	0.2		○		
DCGT070202R-P	7.8	6.35	2.38	2.8	0.2		●		
DCGT070204L-P	7.8	6.35	2.38	2.8	0.4		●		
DCGT070204R-P	7.8	6.35	2.38	2.8	0.4		○		
DCGT11T3003L-P	11.6	9.525	3.97	4.4	0.03		○		
DCGT11T3003R-P	11.6	9.525	3.97	4.4	0.03		○		
DCGT11T301L-P	11.6	9.525	3.97	4.4	0.1		○		
DCGT11T301R-P	11.6	9.525	3.97	4.4	0.1		●		
DCGT11T302L-P	11.6	9.525	3.97	4.4	0.2		●		
DCGT11T302R-P	11.6	9.525	3.97	4.4	0.2		●		
DCGT11T304L-P	11.6	9.525	3.97	4.4	0.4		●		
DCGT11T304R-P	11.6	9.525	3.97	4.4	0.4		●		



● Stock ○ Available Upon Order

Small Part Turning Inserts (Positive)

**DC** □ □

Rhombic 55° with hole

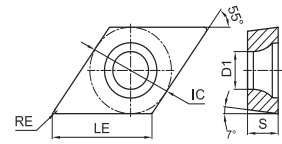

Ordering Code	Dimension (mm)					Coated Carbides			
	LE	IC	S	D1	RE	GAT7115	GAT7120	GAT7120A	GAT7125
DCGT0702005ML-G	7.8	6.35	2.38	2.8	<0.05	○	○		○
DCGT0702005MR-G	7.8	6.35	2.38	2.8	<0.05	●	●		○
DCGT070201MEL-G	7.8	6.35	2.38	2.8	<0.1	○	○		○
DCGT070201MER-G	7.8	6.35	2.38	2.8	<0.1	○	○		○
DCGT070201ML-G	7.8	6.35	2.38	2.8	<0.1	○	○		○
DCGT070201MR-G	7.8	6.35	2.38	2.8	<0.1	●	○		○
DCGT11T3005ML-G	11.6	9.525	3.97	4.4	<0.05	○	○		○
DCGT11T3005MR-G	11.6	9.525	3.97	4.4	<0.05	○	●		○
DCGT11T301MEL-G	11.6	9.525	3.97	4.4	<0.1	○	○		○
DCGT11T301MER-G	11.6	9.525	3.97	4.4	<0.1	○	○		○
DCGT11T301ML-G	11.6	9.525	3.97	4.4	<0.1	○	○		○
DCGT11T301MR-G	11.6	9.525	3.97	4.4	<0.1	●	●		●
DCGT11T302MER-G	11.6	9.525	3.97	4.4	<0.2				●
DCGT11T302MR-G	11.6	9.525	3.97	4.4	<0.2	●	○		●
DCGT070201L-G	7.8	6.35	2.38	2.8	0.1		○		
DCGT070201R-G	7.8	6.35	2.38	2.8	0.1		●		
DCGT070202L-G	7.8	6.35	2.38	2.8	0.2		●		
DCGT070202R-G	7.8	6.35	2.38	2.8	0.2		○		
DCGT11T301EL-G	11.6	9.525	3.97	4.4	0.1		●		
DCGT11T301ER-G	11.6	9.525	3.97	4.4	0.1		●		
DCGT11T301L-G	11.6	9.525	3.97	4.4	0.1		●		
DCGT11T301R-G	11.6	9.525	3.97	4.4	0.1		●		
DCGT11T302EL-G	11.6	9.525	3.97	4.4	0.2		●		
DCGT11T302ER-G	11.6	9.525	3.97	4.4	0.2		●		
DCGT11T302L-G	11.6	9.525	3.97	4.4	0.2		●		
DCGT11T302R-G	11.6	9.525	3.97	4.4	0.2		●		
DCGT11T304EL-G	11.6	9.525	3.97	4.4	0.4		○		
DCGT11T304ER-G	11.6	9.525	3.97	4.4	0.4		●		
DCGT11T302MR-S	11.6	9.525	3.97	4.4	<0.2	○			○
DCGT11T304MR-S	11.6	9.525	3.97	4.4	<0.4	○			●

● Stock ○ Available Upon Order









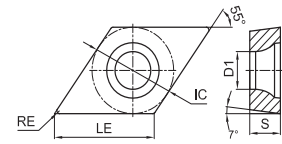











Small Part Turning Inserts (Positive)

**DC** □ □

Rhombic 55° with hole



Ordering Code	Dimension (mm)					Coated Carbides			
	LE	IC	S	D1	RE	GAT7115	GAT7120	GAT7120A	GAT7125
 DCGT070201M-AF	7.8	6.35	2.38	2.8	<0.1	●			●
 DCGT11T301M-AF	11.6	9.525	3.97	4.4	<0.1	○		○	●
 DCGT11T301M-AK	11.6	9.525	3.97	4.4	<0.1	●		○	●
 DCGT11T302M-AK	11.6	9.525	3.97	4.4	<0.2	●		○	●
 DCGT11T304M-AK	11.6	9.525	3.97	4.4	<0.4				○
 DCGT070201M-BF	7.8	6.35	2.38	2.8	<0.1	●		○	●
 DCGT070202M-BF	7.8	6.35	2.38	2.8	<0.2	●			●
 DCGT070204M-BF	7.8	6.35	2.38	2.8	<0.4	●			●
 DCGT11T301M-BF	11.6	9.525	3.97	4.4	<0.1	●		○	●
 DCGT11T302M-BF	11.6	9.525	3.97	4.4	<0.2	●		○	●
 DCGT11T304M-BF	11.6	9.525	3.97	4.4	<0.4	●		○	●
 DCGT070201M-BK	7.8	6.35	2.38	2.8	<0.1	●		○	●
 DCGT070202M-BK	7.8	6.35	2.38	2.8	<0.2	●			●
 DCGT11T301M-BK	11.6	9.525	3.97	4.4	<0.1	●		○	●
 DCGT11T302M-BK	11.6	9.525	3.97	4.4	<0.2	●		○	●
 DCGT11T304M-BK	11.6	9.525	3.97	4.4	<0.4	●			●
 DCGT11T301M-MM	11.6	9.525	3.97	4.4	<0.1	●		○	●
 DCGT11T302M-MM	11.6	9.525	3.97	4.4	<0.2	●		○	●
 DCGT11T304M-MM	11.6	9.525	3.97	4.4	<0.4	●		○	●

● Stock ○ Available Upon Order

Small Part Turning Inserts (Positive)

**TB** □ □

Triangle 60° with hole

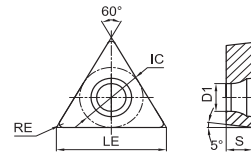

Ordering Code	Dimension (mm)					Coated Carbides			
	LE	IC	S	D1	RE	GAT7115	GAT7120	GAT7120A	GAT7125
 TBGT060102L-P	6.9	3.97	1.59	2.3	0.2		●		
TBGT060104L-P	6.9	3.97	1.59	2.3	0.4		●		

● Stock ○ Available Upon Order

Small Part Turning Inserts (Positive)

**TC** □ □

Triangle 60° with hole

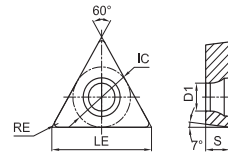

Ordering Code	Dimension (mm)					Coated Carbides			
	LE	IC	S	D1	RE	GAT7115	GAT7120	GAT7120A	GAT7125
 TCGT060102L-P	6.9	3.97	1.59	2.3	0.2		●		
TCGT060104L-P	6.9	3.97	1.59	2.3	0.4		●		
TCGT080202L-P	8.2	4.76	2.38	2.3	0.2		●		
TCGT080204L-P	8.2	4.76	2.38	2.3	0.4		●		
TCGT110202L-P	11	6.35	2.38	2.8	0.2		●		
TCGT110204L-P	11	6.35	2.38	2.8	0.4		●		
TCGT0802005ML-G	8.2	4.76	2.38	2.3	<0.05	○	○		○
TCGT0802005MR-G	8.2	4.76	2.38	2.3	<0.05	○	○		○
TCGT080201ML-G	8.2	4.76	2.38	2.3	<0.1	○	○		○
TCGT080201MR-G	8.2	4.76	2.38	2.3	<0.1	○	○		○
TCGT1103005ML-G	11	6.35	3.18	2.8	<0.05	○	●		○
TCGT1103005MR-G	11	6.35	3.18	2.8	<0.05	○	●		○
TCGT080202L-G	8.2	4.76	2.38	2.3	0.2		○		
TCGT080204L-G	8.2	4.76	2.38	2.3	0.4		○		
TCGT110301L-G	11	6.35	3.18	2.8	0.1		○		
TCGT110302L-G	11	6.35	3.18	2.8	0.2		○		
TCGT110304L-G	11	6.35	3.18	2.8	0.4		●		

● Stock ○ Available Upon Order

Small Part Turning Inserts (Positive)

**TP** □ □  
Triangle 60° with hole

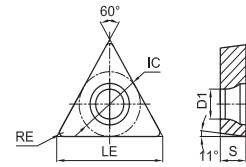

Ordering Code	Dimension (mm)					Coated Carbides			
	LE	IC	S	D1	RE	GAT7115	GAT7120	GAT7120A	GAT7125
TPGH1103005ML-P	11	6.35	3.18	3.4	<0.05	○	●		○
TPGH090202L-P	9.6	5.56	2.38	3.0	0.2		●		
TPGH090204L-P	9.6	5.56	2.38	3.0	0.4		●		
TPGH110301L-P	11	6.35	3.18	3.4	0.1	●	●		
TPGH110302L-P	11	6.35	3.18	3.4	0.2	●	●		
TPGH110304L-P	11	6.35	3.18	3.4	0.4		●		
TPGT080202L-P	8.2	4.76	2.38	2.3	0.2		●		
TPGT080202R-P	8.2	4.76	2.38	2.3	0.2		○		
TPGT080204L-P	8.2	4.76	2.38	2.3	0.4		●		
TPGT080204R-P	8.2	4.76	2.38	2.3	0.4		○		
TPGT080201L-G	8.2	4.76	2.38	2.3	0.1		○		
TPGT080202L-G	8.2	4.76	2.38	2.3	0.2		○		
TPGT080204L-G	8.2	4.76	2.38	2.3	0.4		○		



● Stock ○ Available Upon Order

Small Part Turning Inserts (Positive)

**VB** □ □

Rhombic 35° with hole

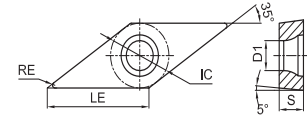

Ordering Code	Dimension (mm)					Coated Carbides			
	LE	IC	S	D1	RE	GAT7115	GAT7120	GAT7120A	GAT7125
VBGT1103005ML-P	11.2	6.35	3.18	2.8	<0.05	○	○		○
VBGT1103005MR-P	11.2	6.35	3.18	2.8	<0.05	●	●		●
VBGT110301ML-P	11.2	6.35	3.18	2.8	<0.1	●	○		●
VBGT110301MR-P	11.2	6.35	3.18	2.8	<0.1	●	○		●
VBGT110302ML-P	11.2	6.35	3.18	2.8	<0.2	○	○		●
VBGT110302MR-P	11.2	6.35	3.18	2.8	<0.2	●	○		●
VBGT1103003L-P	11.2	6.35	3.18	2.8	0.03		○		
VBGT1103003R-P	11.2	6.35	3.18	2.8	0.03		●		
VBGT110301L-P	11.2	6.35	3.18	2.8	0.1		●		
VBGT110301R-P	11.2	6.35	3.18	2.8	0.1		●		
VBGT110302L-P	11.2	6.35	3.18	2.8	0.2		●		
VBGT110302R-P	11.2	6.35	3.18	2.8	0.2		●		
VBGT110304L-P	11.2	6.35	3.18	2.8	0.4		○		
VBGT110304R-P	11.2	6.35	3.18	2.8	0.4		●		
VBGT1103005ML-G	11.2	6.35	3.18	2.8	<0.05	○	●		○
VBGT1103005MR-G	11.2	6.35	3.18	2.8	<0.05	●	●		●
VBGT110301L-G	11.2	6.35	3.18	2.8	0.1		●		
VBGT110301R-G	11.2	6.35	3.18	2.8	0.1		●		
VBGT110302EL-G	11.2	6.35	3.18	2.8	0.2		○		
VBGT110302ER-G	11.2	6.35	3.18	2.8	0.2		○		
VBGT110302R-G	11.2	6.35	3.18	2.8	0.2		○		
VBGT110304EL-G	11.2	6.35	3.18	2.8	0.4		●		
VBGT110304ER-G	11.2	6.35	3.18	2.8	0.4		●		

● Stock ○ Available Upon Order

Small Part Turning Inserts (Positive)

**VB** □ □  
Rhombic 35° with hole

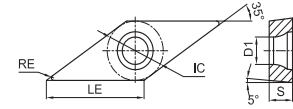

Ordering Code	Dimension (mm)					Coated Carbides			
	LE	IC	S	D1	RE	GAT7115	GAT7120	GAT7120A	GAT7125
VBGT1103005ML-S	11.2	6.35	3.18	2.8	<0.05	○	○		○
VBGT1103005MR-S	11.2	6.35	3.18	2.8	<0.05	●	●		●
VBGT110301ML-S	11.2	6.35	3.18	2.8	<0.1	●	○		○
VBGT110301MR-S	11.2	6.35	3.18	2.8	<0.1	●	○		●
VBGT110302ML-S	11.2	6.35	3.18	2.8	<0.2	●	○		●
VBGT110302MR-S	11.2	6.35	3.18	2.8	<0.2	●	○		●
VBGT110301L-S	11.2	6.35	3.18	2.8	0.1		●		
VBGT110301R-S	11.2	6.35	3.18	2.8	0.1		●		
VBGT110302L-S	11.2	6.35	3.18	2.8	0.2		●		
VBGT110302R-S	11.2	6.35	3.18	2.8	0.2		●		
VBGT110304L-S	11.2	6.35	3.18	2.8	0.4		●		
VBGT110304R-S	11.2	6.35	3.18	2.8	0.4		●		
VBGT160402L-S	16.6	9.525	4.76	4.4	0.2		○		
VBGT160402R-S	16.6	9.525	4.76	4.4	0.2		○		
VBGT160404L-S	16.6	9.525	4.76	4.4	0.4		●		
VBGT160404R-S	16.6	9.525	4.76	4.4	0.4		●		
VBGT110301M-AF	11.2	6.35	3.18	2.8	<0.1	●		○	○
VBGT110301M-BF	11.2	6.35	3.18	2.8	<0.1	●		○	●
VBGT110302M-BF	11.2	6.35	3.18	2.8	<0.2	●		○	●
VBGT110301M-BK	11.2	6.35	3.18	2.8	<0.1	●		○	●
VBGT110302M-BK	11.2	6.35	3.18	2.8	<0.2	●		○	●
VBGT110304M-BK	11.2	6.35	3.18	2.8	<0.4	●			●
VBGT110302M-MM	11.2	6.35	3.18	2.8	<0.2	○		○	○
VBGT110304M-MM	11.2	6.35	3.18	2.8	<0.4	●			○

● Stock ○ Available Upon Order

Small Part Turning Inserts (Positive)

**VC** □ □

Rhombic 35° with hole

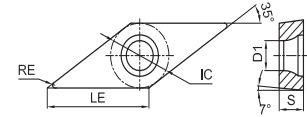

Ordering Code	Dimension (mm)					Coated Carbides			
	LE	IC	S	D1	RE	GAT7115	GAT7120	GAT7120A	GAT7125
VCGT1103005ML-P	11.2	6.35	3.18	2.8	<0.05	○	○		○
VCGT1103005MR-P	11.2	6.35	3.18	2.8	<0.05	○	○		○
VCGT110301ML-P	11.2	6.35	3.18	2.8	<0.1	○	○		○
VCGT110301MR-P	11.2	6.35	3.18	2.8	<0.1	○	○		●
VCGT1103003L-P	11.2	6.35	3.18	2.8	0.03		○		
VCGT1103003R-P	11.2	6.35	3.18	2.8	0.03		○		
VCGT110301L-P	11.2	6.35	3.18	2.8	0.1		○		
VCGT110301R-P	11.2	6.35	3.18	2.8	0.1		○		
VCGT110302L-P	11.2	6.35	3.18	2.8	0.2		○		
VCGT110302R-P	11.2	6.35	3.18	2.8	0.2		○		
VCGT110304L-P	11.2	6.35	3.18	2.8	0.4		○		
VCGT110304R-P	11.2	6.35	3.18	2.8	0.4		○		
VCGT1103005MR-G	11.2	6.35	3.18	2.8	<0.05	●	●		●
VCGT110302R-G	11.2	6.35	3.18	2.8	0.2		○		
VCGT1103005ML-S	11.2	6.35	3.18	2.8	<0.05	○	○		○
VCGT1103005MR-S	11.2	6.35	3.18	2.8	<0.05	○	○		○
VCGT1103003R-S	11.2	6.35	3.18	2.8	0.03		○		
VCGT110301L-S	11.2	6.35	3.18	2.8	0.1		●		
VCGT110301R-S	11.2	6.35	3.18	2.8	0.1		●		
VCGT110302L-S	11.2	6.35	3.18	2.8	0.2		○		
VCGT110302R-S	11.2	6.35	3.18	2.8	0.2		●		

● Stock ○ Available Upon Order

Small Part Turning Inserts (Positive)

**VC** □ □

Rhombic 35° with hole

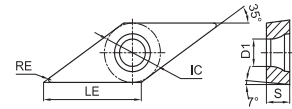

Ordering Code	Dimension (mm)					Coated Carbides			
	LE	IC	S	D1	RE	GAT7115	GAT7120	GAT7120A	GAT7125
VCGT110301M-AF	11.2	6.35	3.18	2.8	<0.1	●		○	●
VCGT080202M-BF	8.3	4.76	2.38	2.3	<0.2	●			●
VCGT110301M-BF	11.2	6.35	3.18	2.8	<0.1	●		○	●
VCGT110302M-BF	11.2	6.35	3.18	2.8	<0.2	●		○	●
VCGT110301M-BK	11.2	6.35	3.18	2.8	<0.1	●		○	●
VCGT110302M-BK	11.2	6.35	3.18	2.8	<0.2	●		○	●
VCGT110304M-BK	11.2	6.35	3.18	2.8	<0.4	●			●
VCGT110302M-MM	11.2	6.35	3.18	2.8	<0.2	●		○	●
VCGT110304M-MM	11.2	6.35	3.18	2.8	<0.4	●			●

● Stock ○ Available Upon Order

Small Part Turning Inserts (Positive)

**VP**   
Rhombic 35° with hole

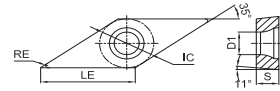

Ordering Code	Dimension (mm)					Coated Carbides			
	LE	IC	S	D1	RE	GAT7115	GAT7120	GAT7120A	GAT7125
VPGT1103005ML-P	11.2	6.35	3.18	2.8	<0.05	○	○		○
VPGT1103005MR-P	11.2	6.35	3.18	2.8	<0.05	●	○		○
VPGT110301ML-P	11.2	6.35	3.18	2.8	<0.1	○	○		○
VPGT110301MR-P	11.2	6.35	3.18	2.8	<0.1	●	○		●
VPGT110302ML-P	11.2	6.35	3.18	2.8	<0.2	○	○		○
VPGT110302MR-P	11.2	6.35	3.18	2.8	<0.2	●	○		●
VPGT1103003L-P	11.2	6.35	3.18	2.8	0.03		○		
VPGT1103003R-P	11.2	6.35	3.18	2.8	0.03		●		
VPGT110301L-P	11.2	6.35	3.18	2.8	0.1		○		
VPGT110301R-P	11.2	6.35	3.18	2.8	0.1		●		
VPGT110302L-P	11.2	6.35	3.18	2.8	0.2		●		
VPGT110302R-P	11.2	6.35	3.18	2.8	0.2		●		
VPGT1103005ML-G	11.2	6.35	3.18	2.8	<0.05	○	○		○
VPGT1103005MR-G	11.2	6.35	3.18	2.8	<0.05	○	○		○
VPGT110301L-G	11.2	6.35	3.18	2.8	0.1		○		
VPGT110301R-G	11.2	6.35	3.18	2.8	0.1		●		
VPGT110302R-G	11.2	6.35	3.18	2.8	0.2	●	●		●
VPGT080201M-BK	8.3	4.76	2.38	2.3	<0.1	○			○
VPGT080202M-BK	8.3	4.76	2.38	2.3	<0.2	○			○

● Stock ○ Available Upon Order



Small Part Turning Inserts (Positive)

**WB** □ □  
Trigon 80°with Hole

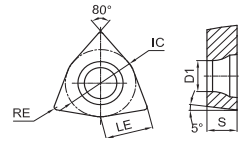

Ordering Code	Dimension (mm)					Coated Carbides			
	LE	IC	S	D1	RE	GAT7115	GAT7120	GAT7120A	GAT7125
WBGTO20101L-P	2.5	3.97	1.59	2.3	0.1		○		
WBGTO20102L-P	2.5	3.97	1.59	2.3	0.2	○	●		○
WBGTO20104L-P	2.5	3.97	1.59	2.3	0.4	○	●		○
WBGTL30202L-P	3.2	4.76	2.38	2.3	0.2		○		
WBGTL30204L-P	3.2	4.76	2.38	2.3	0.4		○		



●Stock ○Available Upon Order

Small Part Turning Inserts (Others)

**GSAB** □ □

Horizontal Back Turning Insert

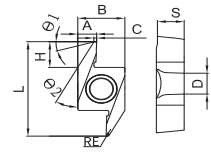

Ordering Code	Dimension (mm)											Coated Carbides			
	A	B	C	D	H	L	RE	S	Ø1	Ø2	GAT7115	GAT7120	GAT7120A	GAT7125	
	GSAB15R4025005	2.8	7.0	0.4	3.4	4.3	15.5	0.05	3.97	15°	30°	●	●		●
	GSAB15R4025005M	2.8	7.0	0.4	3.4	4.3	15.5	<0.05	3.97	15°	30°	●	●		●
	GSAB15R4025015	2.8	7.0	0.4	3.4	4.2	15.4	0.15	3.97	15°	30°	●	●		●
	GSAB15R4025015M	2.8	7.0	0.4	3.4	4.2	15.4	<0.15	3.97	15°	30°	●	●		●
	GSAB15R4045005	4.7	7.0	0.65	3.4	4.3	15.5	0.05	3.97	15°	45°	○	●		○
	GSAB15R4045005M	4.7	7.0	0.65	3.4	4.3	15.5	<0.05	3.97	15°	45°	○	●		○
	GSAB15R4045015	4.7	7.0	0.65	3.4	4.2	15.4	0.15	3.97	15°	45°	●	●		○
	GSAB15R4045015M	4.7	7.0	0.65	3.4	4.2	15.4	<0.15	3.97	15°	45°	●	●		○
	GSAB23R5045005	4.7	7.0	0.55	3.4	5.3	23.5	0.05	3.97	15°	40°	○	●		○
	GSAB23R5045005M	4.7	7.0	0.55	3.4	5.3	23.5	<0.05	3.97	15°	40°	○	●		○
	GSAB23R5045015	4.7	7.0	0.55	3.4	5.2	23.4	0.15	3.97	15°	40°	●	●		○
	GSAB23R5045015M	4.7	7.0	0.55	3.4	5.2	23.4	<0.15	3.97	15°	40°	●	●		○

● Stock ○ Available Upon Order

Back Turning Inserts Code Identification System

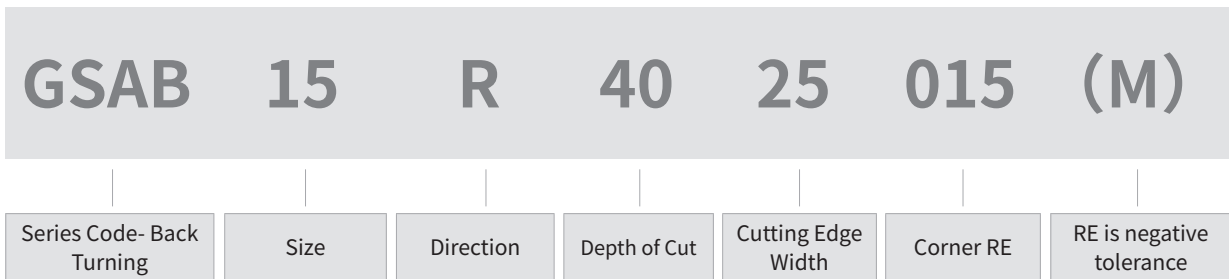

Small Part Turning Inserts (Others)

**GSTB** □ □

Vertical Back Turning Insert

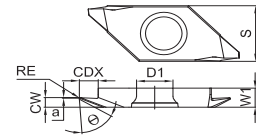

Ordering Code	Dimension (mm)								Coated Carbides			
	CW	CDX	a	Ø	RE	D1	W1	S	GAT7115	GAT7120	GAT7120A	GAT7125
GSTB3R15005M	1.5	2.7	0.25	56°	<0.05	5.2	3.0	8.7	●	●		○
GSTB3R15010M	1.5	2.7	0.25	56°	<0.10	5.2	3.0	8.7	○	●		○
GSTB3R28005M	2.8	4.6	0.3	56°	<0.05	5.2	3.0	8.7	●	○		○
GSTB3R28010M	2.8	4.6	0.3	56°	<0.10	5.2	3.0	8.7	○	●		○
GSTB3R28020	2.8	4.6	0.5	56°	0.20	5.2	3.0	8.7		○		○
GSTB4R38005M	3.8	6.3	0.3	56°	<0.05	5.2	4.0	9.5	●	○		○
GSTB4R38010M	3.8	6.3	0.3	56°	<0.10	5.2	4.0	9.5	●	○		○
GSTB4R38020M	3.8	6.3	0.5	56°	<0.20	5.2	4.0	9.5	○			○

● Stock ○ Available Upon Order

**GSTB 3 R 28 015 (M)**

Series Code-Vertical Back Turning	Size	Direction	Cutting Edge Width	Corner RE	RE is negative tolerance
-----------------------------------	------	-----------	--------------------	-----------	--------------------------

## Overview of Small Part Turning Holders

SCLCR/L-Z	SDJCR/L-Z	SVJ*R/L-Z	SVQ*R-Z	SDJCR
P107	P107	P108	P109	P109
				
SGSAB-4025F	SGSAB-4045F	SGSAB-5045F	GST	GST-RS
P110	P110	P111	P112	P112
				

Small Part Turning Holders

# SCLCR/L-Z

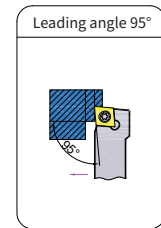
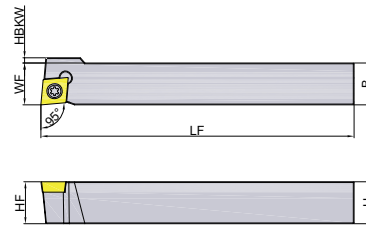

Ordering Code	Dimension (mm)						Insert	Screw	Wrench	Weight (KG)	Stock	
	H	B	LF	HF	WF	HBKW					R	L
SCLCR/L1010JK06Z	10	10	120	10	10	-	CC**0602**	SI60M025065-03509S	TT07PQ	0.09	●	●
SCLCR/L1010JK09Z	10	10	120	10	10	2.5	CC**09T3**	SI60M040089-05313S	TT15PQ	0.09	●	●
SCLCR/L1212JK09Z	12	12	120	12	12	-	CC**09T3**	SI60M040089-05313S	TT15PQ	0.14	●	●
SCLCR/L1616JK09Z	16	16	120	16	16	-	CC**09T3**	SI60M040089-05313S	TT15PQ	0.24	●	●

● Stock ○ Available Upon Order

# SDJCR/L-Z

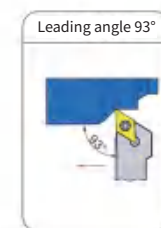
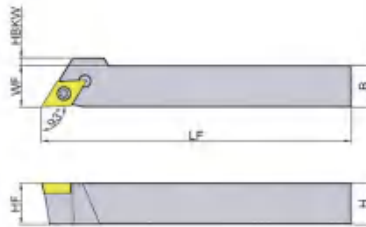



Ordering Code	Dimension (mm)						Insert	Screw	Wrench	Weight (KG)	Stock	
	H	B	LF	HF	WF	HBKW					R	L
SDJCR/L1010JK07Z	10	10	120	10	10	-	DC**0702**	SI60M025065-03509S	TT07PQ	0.09	●	●
SDJCR/L1010JK11Z	10	10	120	10	10	3	DC**11T3**	SI60M040089-05313S	TT15PQ	0.09	●	●
SDJCR/L1212JK11Z	12	12	120	12	12	1	DC**11T3**	SI60M040089-05313S	TT15PQ	0.14	●	●
SDJCR/L1616JK11Z	16	16	120	16	16	-	DC**11T3**	SI60M040089-05313S	TT15PQ	0.24	●	●

● Stock ○ Available Upon Order

Small Part Turning Holders

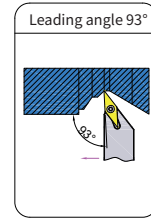
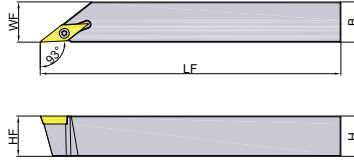
# SVJ\*R/L-Z



Ordering Code	Dimension (mm)						Insert	Screw 	Wrench 	Weight (KG)	Stock	
	H	B	LF	HF	WF	HBKW					R	L
SVJBR/L1010JK11Z	10	10	120	10	10	-	VB**1103**	SI60M025065-03509S	TT07PQ	0.09	●	●
SVJBR/L1212JK11Z	12	12	120	12	12	-	VB**1103**	SI60M025065-03509S	TT07PQ	0.14	●	●
SVJBR/L1616JK11Z	16	16	120	16	16	-	VB**1103**	SI60M025065-03509S	TT07PQ	0.24	●	●
SVJCR/L1010JK11Z	10	10	120	10	10	-	VC**1103**	SI60M025065-03509S	TT07PQ	0.09	●	●
SVJCR/L1212JK11Z	12	12	120	12	12	-	VC**1103**	SI60M025065-03509S	TT07PQ	0.14	●	●
SVJCR/L1616JK11Z	16	16	120	16	16	-	VC**1103**	SI60M025065-03509S	TT07PQ	0.24	●	●
SVJPR/L1212JK11Z	12	12	120	12	12	-	VP**1103**	SI60M025065-03509S	TT07PQ	0.14	●	●
SVJPR/L1616JK11Z	16	16	120	16	16	-	VP**1103**	SI60M025065-03509S	TT07PQ	0.24	●	●

● Stock ○ Available Upon Order

Small Part Turning Holders

# SVQ\*R-Z

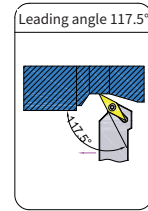
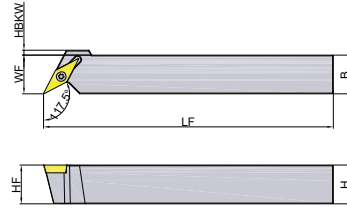

Ordering Code	Dimension (mm)						Insert	Screw	Wrench	Weight (KG)	Stock	
	H	B	LF	HF	WF	HBKW					R	L
SVQCR1010JK11Z	10	10	120	10	10	8	VC**1103**	SI60M025065-03509S	TT07PQ	0.09	●	
SVQCR1212JK11Z	12	12	120	12	12	6	VC**1103**	SI60M025065-03509S	TT07PQ	0.14	●	
SVQCR1616JK11Z	16	16	120	16	16	2	VC**1103**	SI60M025065-03509S	TT07PQ	0.24	●	
SVQPR1010JK08Z	10	10	120	10	10	4	VP**0802**	SI60M020050-02806S	TT06PQ	0.09	●	
SVQPR1010JK11Z	10	10	120	10	10	8	VP**1103**	SI60M025065-03509S	TT07PQ	0.09	●	
SVQPR1212JK08Z	12	12	120	12	12	2	VP**0802**	SI60M020050-02806S	TT06PQ	0.14	●	
SVQPR1212JK11Z	12	12	120	12	12	6	VP**1103**	SI60M025065-03509S	TT07PQ	0.14	●	
SVQPR1616JK08Z	16	16	120	16	16	-	VP**0802**	SI60M020050-02806S	TT06PQ	0.24	●	
SVQPR1616JK11Z	16	16	120	16	16	2	VP**1103**	SI60M025065-03509S	TT07PQ	0.24	●	

●Stock ○Available Upon Order

# SDJCR

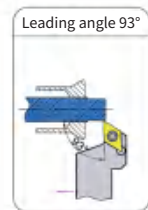
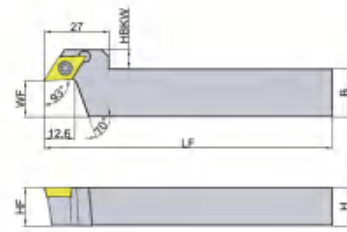

Ordering Code	Dimension (mm)						Insert	Screw	Wrench	Weight (KG)	Stock	
	H	B	LF	HF	WF	HBKW					R	L
SDJCR1216JK11F15	12	16	120	12	15	12	DC**11T3**	SI60M040089-05313S	TT15PQ	0.18	●	
SDJCR1620JK11F15	16	20	120	16	15	8	DC**11T3**	SI60M040089-05313S	TT15PQ	0.30	●	

●Stock ○Available Upon Order

## Turning Holder for Small Part -Back Turning Holder(GSAB)

## SGSAB-4025F

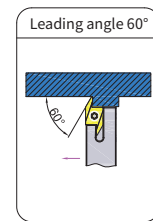
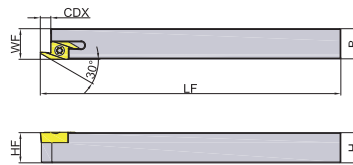

Ordering Code	Dimension (mm)						Insert	Screw	Wrench	Weight (KG)	Stock	
	H	B	LF	HF	WF	CDX					R	L
SGSABR1010JK4025F	10	10	120	10	10.2	4.2	GSAB15R4025**	SI60M030072-04210S	TT09PQ	0.09	●	
SGSABR1212JK4025F	12	12	120	12	12.2	4.2	GSAB15R4025**	SI60M030072-04210S	TT09PQ	0.14	●	
SGSABR1616JK4025F	16	16	120	16	16.2	4.2	GSAB15R4025**	SI60M030072-04210S	TT09PQ	0.24	●	

●Stock ○Available Upon Order

## SGSAB-4045F

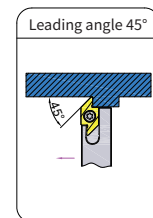
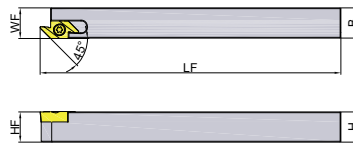

Ordering Code	Dimension (mm)						Insert	Screw	Wrench	Weight (KG)	Stock	
	H	B	LF	HF	WF	CDX					R	L
SGSABR1010JK4045F	10	10	120	10	10.2	4.2	GSAB15R4045**	SI60M030072-04210S	TT09PQ	0.09	●	
SGSABR1212JK4045F	12	12	120	12	12.2	4.2	GSAB15R4045**	SI60M030072-04210S	TT09PQ	0.14	●	
SGSABR1616JK4045F	16	16	120	16	16.2	4.2	GSAB15R4045**	SI60M030072-04210S	TT09PQ	0.24	●	



●Stock ○Available Upon Order

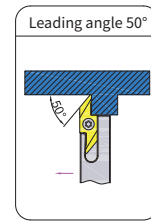
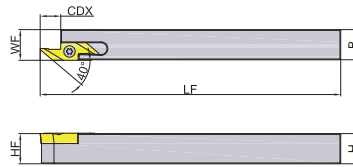

Turning Holder for Small Part -Back Turning Holder(GSAB)

# SGSAB-5045F



Ordering Code	Dimension (mm)						Insert	Screw 	Wrench 	Weight (KG)	Stock	
	H	B	LF	HF	WF	CDX					R	L
SGSABR1010JK5045F	10	10	120	10	10.2	8.2	GSAB23R5045**	SI60M030072-04210S	TT09PQ	0.09	●	
SGSABR1212JK5045F	12	12	120	12	12.2	8.2	GSAB23R5045**	SI60M030072-04210S	TT09PQ	0.14	●	
SGSABR1616JK5045F	16	16	120	16	16.2	8.2	GSAB23R5045**	SI60M030072-04210S	TT09PQ	0.24	●	

●Stock ○Available Upon Order

Turning Holder for Small Part -Back Turning Holder

# GST

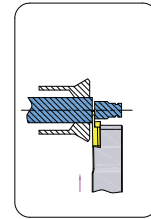
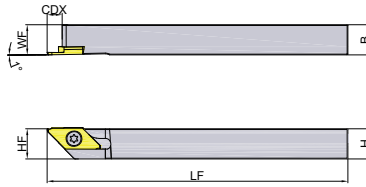

Ordering Code	Dimension (mm)						Insert	Screw	Wrench	Weight (KG)	Stock	
	H	B	LF	HF	WF	CDX					R	L
GSTR/L1010JK3	10	10	120	10	10	6	GST*3R/L**	SSAM045095Q	TT10PQ	0.09	●	○
GSTR/L1010JK4	10	10	120	10	10	8	GST*4R/L**	SSAM045095Q	TT10PQ	0.09	●	○
GSTR/L1212JK3	12	12	120	12	12	6	GST*3R/L**	SSAM045095Q	TT10PQ	0.14	●	○
GSTR/L1212JK4	12	12	120	12	12	8	GST*4R/L**	SSAM045095Q	TT10PQ	0.14	●	○
GSTR/L1616JK3	16	16	120	16	16	6	GST*3R/L**	SSAM045095Q	TT10PQ	0.24	●	○
GSTR/L1616JK4	16	16	120	16	16	8	GST*4R/L**	SSAM045095Q	TT10PQ	0.24	●	○
GSTR/L2020JK3	20	20	120	20	20	6	GST*3R/L**	SSAM045095Q	TT10PQ	0.40	●	○
GSTR/L2020JK4	20	20	120	20	20	8	GST*4R/L**	SSAM045095Q	TT10PQ	0.40	●	○

● Stock ○ Available Upon Order

# GST-RS

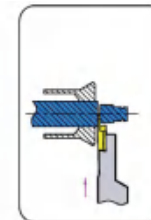
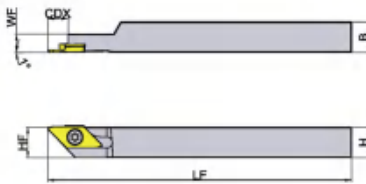

Ordering Code	Dimension (mm)						Insert	Screw	Wrench	Weight (KG)	Stock	
	H	B	LF	HF	WF	CDX					R	L
GSTR/L1010JK3-RS	10	10	120	10	7.2	6	GST*3R/L**	SSAM045070Q	TT10PQ	0.09	●	○
GSTR/L1212JK3-RS	12	12	120	12	7.2	6	GST*3R/L**	SSAM045070Q	TT10PQ	0.14	●	○
GSTR/L1010JK4-RS	10	10	120	10	7.2	8	GST*4R/L**	SSAM045070Q	TT10PQ	0.09	●	○
GSTR/L1212JK4-RS	12	12	120	12	7.2	8	GST*4R/L**	SSAM045070Q	TT10PQ	0.14	●	○

● Stock ○ Available Upon Order

## Recommended Cutting Datas

ISO	Workpiece Materials	Hardness	Chip Breaker	Grade	Min-Optimum-Max		
					Cutting Speed Vc(m/min)	Cutting Depth ap(mm)	Feeding Rate f(mm/rev)
<b>P</b>	Steel	≤HB300	P	GAT7115	60-120-180	0.03-0.1-0.5	0.03-0.1-0.18
				GAT7120	40-90-140		
				GAT7125	40-90-150		
			G	GAT7115	60-120-180	0.3-0.8-2.5	0.01-0.05-0.08
				GAT7120	40-90-140		
				GAT7125	40-90-150		
			S	GAT7115	60-120-180	0.3-0.8-2	0.08-0.12-0.25
				GAT7120	40-90-140		
				GAT7125	40-90-150		
			AF	GAT7115	60-120-180	0.02-0.16-0.2	0.03-0.08-0.12
				GAT7125	40-90-150		
				GAT7120A	50-100-160		
			AK	GAT7115	60-120-180	0.3-1.4-2.5	0.02-0.07-0.12
				GAT7125	40-90-150		
				GAT7120A	50-100-160		
			BF	GAT7115	60-120-180	0.2-0.7-1.2	0.02-0.06-0.12
				GAT7125	40-90-150		
				GAT7120A	50-100-160		
			BK	GAT7115	60-120-180	0.8-1.6-2.5	0.03-0.08-0.12
				GAT7125	40-90-150		
				GAT7120A	50-100-160		
			MM	GAT7115	60-120-180	0.8-1.8-3	0.03-0.06-0.1
				GAT7125	40-90-150		
				GAT7120A	50-100-160		

## Recommended Cutting Datas

ISO	Workpiece Materials	Hardness	Chip Breaker	Grade	Min-Optimum-Max		
					Cutting Speed Vc(m/min)	Cutting Depth ap(mm)	Feeding Rate f(mm/rev)
<b>M</b>	Stainless Steel	≤HB300	P	GAT7115	60-100-150	0.03-0.1-0.5	0.03-0.1-0.18
				GAT7120	40-80-120		
				GAT7125	40-80-130		
			G	GAT7115	60-100-150	0.3-0.8-2.5	0.01-0.05-0.08
				GAT7120	40-80-120		
				GAT7125	40-80-130		
			S	GAT7115	60-100-150	0.3-0.8-2	0.08-0.12-0.25
				GAT7120	40-80-120		
				GAT7125	40-80-130		
			AF	GAT7115	60-100-150	0.02-0.16-0.2	0.03-0.08-0.12
				GAT7125	40-80-130		
			AK	GAT7115	60-100-150	0.3-1.4-2.5	0.02-0.07-0.12
				GAT7125	40-80-130		
			BF	GAT7115	60-100-150	0.2-0.7-1.2	0.02-0.06-0.12
				GAT7125	40-80-130		
			BK	GAT7115	60-100-150	0.8-1.6-2.5	0.03-0.08-0.12
				GAT7125	40-80-130		
			MM	GAT7115	60-100-150	0.8-1.8-3	0.03-0.06-0.1
GAT7125	40-80-130						

ISO	Workpiece Materials	Hardness	Chip Breaker	Grade	Min-Optimum-Max			
					Cutting Speed Vc(m/min)	Cutting Depth ap(mm)	Grooving Feed f1(mm/rev)	Horizontal Feed f2(mm/rev)
<b>P</b>	Steel	≤HB300	GSAB	GAT7115	60-120-180	0.5-2.0-5.0	0.01-0.02-0.03	0.01-0.05-0.1
				GAT7120	40-90-140			
				GAT7125	40-90-150			
			GSTB	GAT7115	60-120-180	0.5-2.5-6.0	0.01-0.02-0.03	0.01-0.05-0.15
				GAT7120	40-90-140			
				GAT7125	40-90-150			
<b>M</b>	Stainless Steel	≤HB300	GSAB	GAT7115	60-100-150	0.5-2.0-5.0	0.01-0.02-0.03	0.01-0.05-0.1
				GAT7120	40-80-120			
				GAT7125	40-80-130			
			GSTB	GAT7115	60-100-150	0.5-2.5-6.0	0.01-0.02-0.03	0.01-0.05-0.15
				GAT7120	40-80-120			
				GAT7125	40-80-130			

D

PCBN/PCD TURNING





# PCBN/PCD Turning Indexable Inserts Identification System

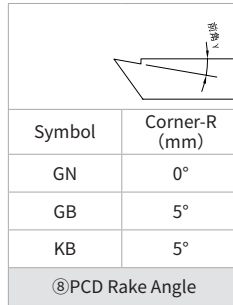

⑥                      ⑦                      ⑧                      ⑨

<b>T3</b>	<b>04</b>	<b>GB</b>	<b>-</b>	<b>1</b>
<b>04</b>	<b>08</b>	<b>M</b>	<b>-</b>	<b>3</b>

⑥                      ⑦                      ⑧                      ⑨



















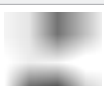





⑥Thickness	
Symbol	Thickness
01	1.59
02	2.38
T2	2.78
03	3.18
T3	3.97
04	4.76
05	5.56
06	6.35
07	7.94
09	9.52

⑦Corner Rc Symbol	
Symbol	CR(mm)
00	0.03
02	0.2
04	0.4
08	0.8
12	1.2
16	1.6
20	2.0
24	2.4
28	2.8
32	3.2

⑧PCBN Edge Type	
Symbol	Edge Type
L	Continues Standard
LS	Continues Others
M	Continues Gerenal
H	Interrupted Strength

⑨Number of	
Symbol	Number of
1	1
2	2
3	3
4	4
6	6

## Overview of PCBN/PCD Turning Inserts

Type	Features		Rhombic 80°	Rhombic 55°	Triangle 60°	Rhombic 35°	Trigon 80°	Square 90°	Round 360°	
Brazed	<ul style="list-style-type: none"> <li>• Higher precision and longer tool life.</li> <li>• Wide range of insert types</li> </ul>	Negative PCBN								
			CNGA	DNGA	TNGA	VNGA	WNGA			
			P119	P120	P121	P122	P123			
		Positive PCBN								
			CCGW	DCGW	TCGW/TPGW	VBGW/VCGW				
			P124	P124	P125	P127				
		Positive PCD								
			CCGW	DCGW	TCGW/TPGW	VCGW			RDEW	
			P133	P133	P134-135	P136			P136	
Brazed Solid	<ul style="list-style-type: none"> <li>• Available on both sides, more economical.</li> <li>• Has strong welding stability.</li> </ul>	Negative PCBN								
			CNGA	DNGA	TNGA	VNGA	WNGA			
			P127	P127	P128	P128	P129			
Solid	<ul style="list-style-type: none"> <li>• Integral structure, processing for large margin or unstable working conditions</li> </ul>	Negative PCBN								
			CNGN	DNGN			WNGN	SNGN	RNGN	
		P130	P130			P131	P131	P132		
		Positive PCBN								
									RCGN	
							P132			



PCBN Insert (Negative)

CN □ □

Rhombic 80° with Hole

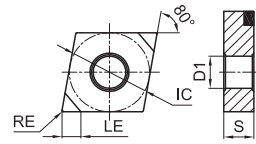

Ordering code	Edge	Dimension (mm)					PCBN Grade		Coated PCBN						
		LE	IC	S	D1	RE	BKN115P	BSN115P	BKC120P	BHC115P	BHC125P	BHC135P	BHC210P	BHC225P	
CNGA120404LS-2	2	2.2	12.7	4.76	5.16	0.4	○	●		●				●	●
CNGA120408LS-2	2	2.2	12.7	4.76	5.16	0.8		●		○				●	
CNGA120404M-2	2	2.2	12.7	4.76	5.16	0.4		●	○	○	●	●			●
CNGA120408M-2	2	2.2	12.7	4.76	5.16	0.8	○	○	○		●	●	●	●	●
CNGA120412M-2	2	2.2	12.7	4.76	5.16	1.2					●	●			●
CNGA120408H-2	2	2.2	12.7	4.76	5.16	0.8					●		●	●	●
CNGA120404LS-4	4	2.2	12.7	4.76	5.16	0.4								●	
CNGA120408LS-4	4	2.2	12.7	4.76	5.16	0.8								●	
CNGA120404M-4	4	2.2	12.7	4.76	5.16	0.4									●
CNGA120408M-4	4	2.2	12.7	4.76	5.16	0.8									●
CNGA120412M-4	4	2.2	12.7	4.76	5.16	1.2									●
CNGA120408H-4	4	2.2	12.7	4.76	5.16	0.8									●



● Stock ○ Available Upon Order

PCBN Insert (Negative)

**DN** □ □

Rhombic 55° with Hole

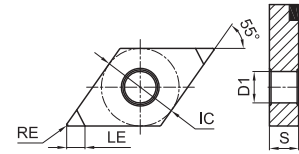

Ordering code	Edge	Dimension (mm)					PCBN Grade		Coated PCBN					
		LE	IC	S	D1	RE	BKNI15P	BSNI15P	BKC120P	BHC115P	BHC125P	BHC135P	BHC210P	BHC225P
DNGA150404LS-2	2	2.2	12.7	4.76	5.16	0.4	●			●				○
DNGA150408LS-2	2	2.2	12.7	4.76	5.16	0.8								●
DNGA150404M-2	2	2.2	12.7	4.76	5.16	0.4					●	○	●	●
DNGA150408M-2	2	2.2	12.7	4.76	5.16	0.8	●	●	●		●	●		●
DNGA150412M-2	2	2.2	12.7	4.76	5.16	1.2		○			○	●		●
DNGA150608M-2	2	2.2	12.7	6.35	5.16	0.8						○		○
DNGA150612M-2	2	2.2	12.7	6.35	5.16	1.2	○				○			○
DNGA150404LS-4	4	2.2	12.7	4.76	5.16	0.4								●
DNGA150408LS-4	4	2.2	12.7	4.76	5.16	0.8								●
DNGA150404M-4	4	2.2	12.7	4.76	5.16	0.4								●
DNGA150408M-4	4	2.2	12.7	4.76	5.16	0.8								●
DNGA150412M-4	4	2.2	12.7	4.76	5.16	1.2								●
DNGA150604M-4	4	2.2	12.7	6.35	5.16	0.4								●
DNGA150608M-4	4	2.2	12.7	6.35	5.16	0.8								●
DNGA150612M-4	4	2.2	12.7	6.35	5.16	1.2								●



● Stock ○ Available Upon Order

PCBN Insert (Negative)

**TN** □ □  
Triangle 60° with hole

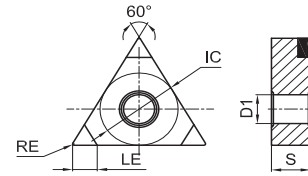

Ordering code	Edge	Dimension (mm)					PCBN Grade		Coated PCBN						
		LE	IC	S	D1	RE	BKNI15P	BSNI15P	BKC120P	BHC115P	BHC125P	BHC135P	BHC210P	BHC225P	
TNGA160404LS-3	3	2.2	9.525	4.76	3.81	0.4									●
TNGA160408LS-3	3	2.2	9.525	4.76	3.81	0.8				●				●	
TNGA160404M-3	3	2.2	9.525	4.76	3.81	0.4	●		●	●	●	●	●	●	●
TNGA160408M-3	3	2.2	9.525	4.76	3.81	0.8	○			●	●	●	●	●	●
TNGA160412M-3	3	2.2	9.525	4.76	3.81	1.2					○	○			○
TNGA160404H-3	3	2.2	9.525	4.76	3.81	0.4									●
TNGA160408H-3	3	2.2	9.525	4.76	3.81	0.8					○	○			●
TNGA160404LS-6	6	2.2	9.525	4.76	3.81	0.4								●	
TNGA160408LS-6	6	2.2	9.525	4.76	3.81	0.8								●	
TNGA160404M-6	6	2.2	9.525	4.76	3.81	0.4									●
TNGA160408M-6	6	2.2	9.525	4.76	3.81	0.8									●
TNGA160412M-6	6	2.2	9.525	4.76	3.81	1.2									●
TNGA160408H-6	6	2.2	9.525	4.76	3.81	0.8									●

● Stock ○ Available Upon Order

PCBN Insert (Negative)

**VN** □ □

Rhombic 35° with Hole

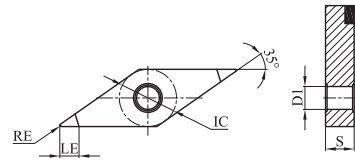

Ordering code	Edge	Dimension (mm)					PCBN Grade		Coated PCBN					
		LE	IC	S	D1	RE	BKN115P	BSN115P	BKC120P	BHC115P	BHC125P	BHC135P	BHC210P	BHC225P
VNGA160404LS-2	2	2.2	9.525	4.76	3.81	0.4				●				●
VNGA160408LS-2	2	2.2	9.525	4.76	3.81	0.8				○				●
VNGA160404M-2	2	2.2	9.525	4.76	3.81	0.4				●	●	●	●	●
VNGA160408M-2	2	2.2	9.525	4.76	3.81	0.8					●	●	○	●
VNGA160412M-2	2	2.2	9.525	4.76	3.81	1.2				●				●
VNGA160404LS-4	4	2.2	9.525	4.76	3.81	0.4								●
VNGA160408LS-4	4	2.2	9.525	4.76	3.81	0.8								●
VNGA160404M-4	4	2.2	9.525	4.76	3.81	0.4								●
VNGA160408M-4	4	2.2	9.525	4.76	3.81	0.8								●
VNGA160412M-4	4	2.2	9.525	4.76	3.81	1.2								●



● Stock ○ Available Upon Order

PCBN Insert (Negative)

—

**WN** □ □

Trigon 80° with hole

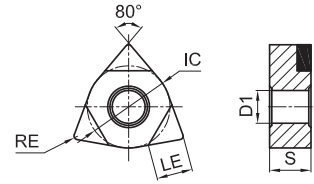

Ordering code	Edge	Dimension (mm)					PCBN Grade		Coated PCBN						
		LE	IC	S	D1	RE	BKN115P	BSN115P	BKC120P	BHC115P	BHC125P	BHC135P	BHC210P	BHC225P	
WNGA080404LS-3	3	2.2	12.7	4.76	5.16	0.4				○				●	
WNGA080408LS-3	3	2.2	12.7	4.76	5.16	0.8				●				●	
WNGA080404M-3	3	2.2	12.7	4.76	5.16	0.4					●	●			●
WNGA080408M-3	3	2.2	12.7	4.76	5.16	0.8	●	○	○		●	●			●
WNGA080412M-3	3	2.2	12.7	4.76	5.16	1.2		○				●			○
WNGA080408H-3	3	2.2	12.7	4.76	5.16	0.8		●			●				●
WNGA080404LS-6	6	2.2	12.7	4.76	5.16	0.4								●	
WNGA080408LS-6	6	2.2	12.7	4.76	5.16	0.8								●	
WNGA080404M-6	6	2.2	12.7	4.76	5.16	0.4									●
WNGA080408M-6	6	2.2	12.7	4.76	5.16	0.8									●
WNGA080412M-6	6	2.2	12.7	4.76	5.16	1.2									●



● Stock ○ Available Upon Order

PCBN Insert (Positive)



Rhombic 80° with Hole

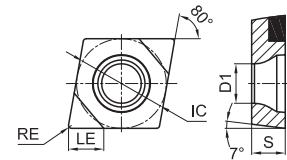

Ordering code	Edge	Dimension (mm)						PCBN Grade		Coated PCBN					
		LE	IC	S	D1	RE	BKN115P	BSN115P	BKC120P	BHC115P	BHC125P	BHC135P	BHC210P	BHC225P	
CCGW060202L-2	2	2	6.35	2.38	2.8	0.2					○		●	●	
CCGW060204L-2	2	2	6.35	2.38	2.8	0.4			○	●	●		●	●	
CCGW060208L-2	2	2	6.35	2.38	2.8	0.8		○			○		○		
CCGW060204M-2	2	2	6.35	2.38	2.8	0.4					●		●	●	
CCGW060208M-2	2	2	6.35	2.38	2.8	0.8					●		●	●	
CCGW09T304L-2	2	2	9.525	3.97	4.4	0.4	●			●			●	●	
CCGW09T308L-2	2	2	9.525	3.97	4.4	0.8				○	○		○		
CCGW09T304M-2	2	2	9.525	3.97	4.4	0.4	●	○	○		●	●	●	●	
CCGW09T308M-2	2	2	9.525	3.97	4.4	0.8	●	○	○	●	●	●		●	
CCGW09T304H-2	2	2	9.525	3.97	4.4	0.4								●	
CCGW09T308H-2	2	2	9.525	3.97	4.4	0.8					●	○		●	



●Stock ○Available Upon Order



Rhombic 55° with Hole

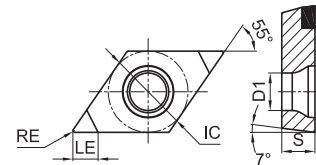

Ordering code	Edge	Dimension (mm)						PCBN Grade		Coated PCBN					
		LE	IC	S	D1	RE	BKN115P	BSN115P	BKC120P	BHC115P	BHC125P	BHC135P	BHC210P	BHC225P	
DCGW070202L-2	2	2	6.35	2.38	2.8	0.2					●		●	●	
DCGW070204L-2	2	2	6.35	2.38	2.8	0.4			○	○	●		●	●	
DCGW070204M-2	2	2	6.35	2.38	2.8	0.4					○			○	
DCGW070208M-2	2	2	6.35	2.38	2.8	0.8					○			●	
DCGW11T304L-2	2	2	9.525	3.97	4.4	0.4	○		○				●		
DCGW11T308L-2	2	2	9.525	3.97	4.4	0.8	○			○			●		
DCGW11T302M-2	2	2	9.525	3.97	4.4	0.2							●		
DCGW11T304M-2	2	2	9.525	3.97	4.4	0.4	●	●	●	●	●	●	●	●	
DCGW11T308M-2	2	2	9.525	3.97	4.4	0.8	●		●	●	●	●	●	●	





●Stock ○Available Upon Order

PCBN Insert (Positive)

**TC** □ □

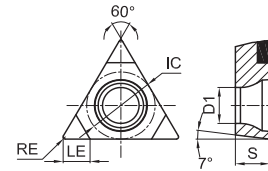
Triangle 60° with Hole





Ordering code	Edge	Dimension (mm)					PCBN Grade		Coated PCBN					
		LE	IC	S	D1	RE	BKNI15P	BSNI15P	BKC120P	BHC115P	BHC125P	BHC135P	BHC210P	BHC225P
 TCGW110304L-3	3	2	6.35	3.18	3.4	0.4	○							○
TCGW110304M-3	3	2	6.35	3.18	3.4	0.4					●			○
TCGW110308M-3	3	2	6.35	3.18	3.4	0.8						○		○

● Stock ○ Available Upon Order

**TP** □ □

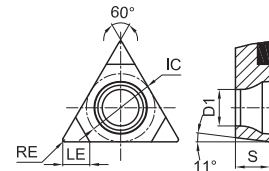
Triangle 60° with Hole



Ordering code	Edge	Dimension (mm)					PCBN Grade		Coated PCBN					
		LE	IC	S	D1	RE	BKNI15P	BSNI15P	BKC120P	BHC115P	BHC125P	BHC135P	BHC210P	BHC225P
 TPGW080202L-1	1	2	4.76	2.38	2.34	0.2		●		○				○
TPGW080204L-1	1	2	4.76	2.38	2.34	0.4				●				●
TPGW080208L-1	1	2	4.76	2.38	2.34	0.8				○				○
TPGW090202L-3	3	2	5.56	2.38	2.8	0.2				○	○			○
TPGW090204L-3	3	2	5.56	2.38	2.8	0.4	●	○		○	●			●
TPGW090208L-3	3	2	5.56	2.38	2.8	0.8	○							○
TPGW110204L-3	3	2	6.35	2.38	2.8	0.4		●		○				○
TPGW110208M-3	3	2	6.35	2.38	2.8	0.8								○
TPGW110302L-3	3	2	6.35	3.18	3.4	0.2								○
TPGW110304L-3	3	2	6.35	3.18	3.4	0.4	●	●	○	●	●		●	●
TPGW110308L-3	3	2	6.35	3.18	3.4	0.8				●	●		●	●
TPGW110304M-3	3	2	6.35	3.18	3.4	0.4					○	○		○
TPGW110308M-3	3	2	6.35	3.18	3.4	0.8					○			○

● Stock ○ Available Upon Order

PCBN Insert (Positive)

**VB** □ □  
Rhombic 35° with Hole

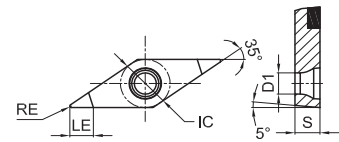

Ordering code	Edge	Dimension (mm)						PCBN Grade		Coated PCBN					
		LE	IC	S	D1	RE	BKN115P	BSN115P	BKC120P	BHC115P	BHC125P	BHC135P	BHC210P	BHC225P	
VBGW110302L-2	2	2	6.35	3.18	2.8	0.2			○		○	○	○		
VBGW110304L-2	2	2	6.35	3.18	2.8	0.4			●	○	●		○		
VBGW110308L-2	2	2	6.35	3.18	2.8	0.8					○	○	○		
VBGW110304M-2	2	2	6.35	3.18	2.8	0.4					○			●	
VBGW110308M-2	2	2	6.35	3.18	2.8	0.8					○			○	
VBGW160404L-2	2	2	9.525	4.76	4.4	0.4	○				○		●		
VBGW160408L-2	2	2	9.525	4.76	4.4	0.8	○				○		○		
VBGW160404M-2	2	2	9.525	4.76	4.4	0.4				○	●	○		●	
VBGW160408M-2	2	2	9.525	4.76	4.4	0.8				●	○	●	●	●	
CCGW09T304H-2	2	2	9.525	3.97	4.4	0.4								●	
CCGW09T308H-2	2	2	9.525	3.97	4.4	0.8					●	○		●	



● Stock ○ Available Upon Order

**VC** □ □  
Rhombic 35° with Hole

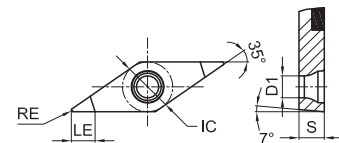

Ordering code	Edge	Dimension (mm)						PCBN Grade		Coated PCBN					
		LE	IC	S	D1	RE	BKN115P	BSN115P	BKC120P	BHC115P	BHC125P	BHC135P	BHC210P	BHC225P	
VCGW110302L-2	2	2	6.35	3.18	2.8	0.2			○				○		
VCGW110304L-2	2	2	6.35	3.18	2.8	0.4	●			○			●		
VCGW110308L-2	2	2	6.35	3.18	2.8	0.8				○			○		
VCGW110308M-2	2	2	6.35	3.18	2.8	0.8	○							○	
VCGW160404L-2	2	2	9.525	4.76	4.4	0.4					○		○	○	
VCGW160408L-2	2	2	9.525	4.76	4.4	0.8					○		○		
VCGW160402M-2	2	2	9.525	4.76	4.4	0.2							●		
VCGW160404M-2	2	2	9.525	4.76	4.4	0.4	●						●		
VCGW160408M-2	2	2	9.525	4.76	4.4	0.8					●			●	



● Stock ○ Available Upon Order



PCBN Insert (Negative)

**CN** □ □

Rhombic 80° with Hole

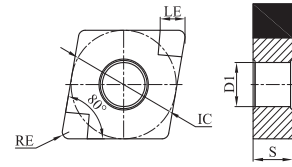

Ordering code	Edge	Dimension (mm)					PCBN Grade	Coated PCBN	
		LE	IC	S	D1	RE		BKN225Z	BHC215Z
CNGA120404LS-4	4	2.2	12.7	4.76	5.16	0.4	○	●	
CNGA120408LS-4	4	2.2	12.7	4.76	5.16	0.8	○	●	
CNGA120412LS-4	4	2.2	12.7	4.76	5.16	1.2	○	○	
CNGA120404M-4	4	2.2	12.7	4.76	5.16	0.4	○	○	○
CNGA120408M-4	4	2.2	12.7	4.76	5.16	0.8	●	●	●
CNGA120412M-4	4	2.2	12.7	4.76	5.16	1.2	○	○	●
CNGA120412H-4	4	2.2	12.7	4.76	5.16	1.2	●		●



● Stock ○ Available Upon Order

**DN** □ □

Rhombic 55° with Hole

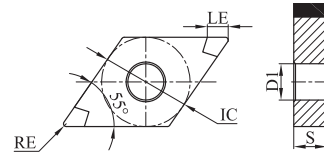

Ordering code	Edge	Dimension (mm)					PCBN Grade	Coated PCBN	
		LE	IC	S	D1	RE		BKN225Z	BHC215Z
DNGA150404LS-4	4	2.2	12.7	4.76	5.16	0.4	○	○	
DNGA150408LS-4	4	2.2	12.7	4.76	5.16	0.8	○	○	
DNGA150404M-4	4	2.2	12.7	4.76	5.16	0.4	○	○	○
DNGA150408M-4	4	2.2	12.7	4.76	5.16	0.8	●	●	●
DNGA150412M-4	4	2.2	12.7	4.76	5.16	1.2	○	○	○
DNGA150412H-4	4	2.2	12.7	4.76	5.16	1.2	○	○	●





● Stock ○ Available Upon Order

## PCBN Insert (Negative)

**TN**□□

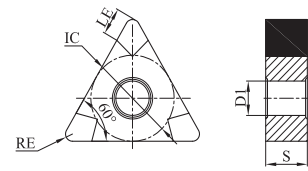
Triangle 60° with Hole





Ordering code	Edge	Dimension (mm)					PCBN Grade	Coated PCBN		
		LE	IC	S	D1	RE		BKN225Z	BHC215Z	BHC225Z
	TNGA160404LS-6	6	2.2	9.525	4.76	3.81	0.4	○	●	
	TNGA160408LS-6	6	2.2	9.525	4.76	3.81	0.8	○	○	
	TNGA160404M-6	6	2.2	9.525	4.76	3.81	0.4	○	○	●
	TNGA160408M-6	6	2.2	9.525	4.76	3.81	0.8	●	●	●
	TNGA160412M-6	6	2.2	9.525	4.76	3.81	1.2	○	○	●

●Stock ○Available Upon Order

**VN**□□

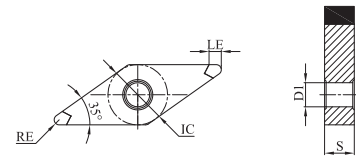
Rhombic 35° with Hole



Ordering code	Edge	Dimension (mm)					PCBN Grade	Coated PCBN		
		LE	IC	S	D1	RE		BKN225Z	BHC215Z	BHC225Z
	VNGA160404LS-4	4	2.2	9.525	4.76	3.81	0.4	○	●	
	VNGA160408LS-4	4	2.2	9.525	4.76	3.81	0.8	○	○	
	VNGA160404M-4	4	2.2	9.525	4.76	3.81	0.4	○	○	○
	VNGA160408M-4	4	2.2	9.525	4.76	3.81	0.8	●	●	●
	VNGA160412M-4	4	2.2	9.525	4.76	3.81	1.2	○	○	○

●Stock ○Available Upon Order

## PCBN Insert (Negative)

**WN** □ □

Trigon 80° with Hole

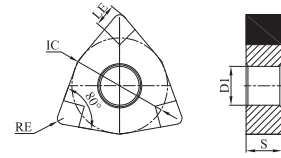

Ordering code	Edge	Dimension (mm)					PCBN Grade	Coated PCBN		
		LE	IC	S	D1	RE		BKN225Z	BHC215Z	BHC225Z
	WNGA080404LS-6	6	2.2	12.7	4.76	5.16	0.4	○	●	
	WNGA080408LS-6	6	2.2	12.7	4.76	5.16	0.8	○	○	○
	WNGA080404M-6	6	2.2	12.7	4.76	5.16	0.4	●	○	○
	WNGA080408M-6	6	2.2	12.7	4.76	5.16	0.8	●	●	●
	WNGA080412M-6	6	2.2	12.7	4.76	5.16	1.2	●	○	●
	WNGA080412H-6	6	2.2	12.7	4.76	5.16	1.2	●	○	●

● Stock ○ Available Upon Order

PCBN Insert (Negative)

**CN** □ □

Rhombic 80° without Hole

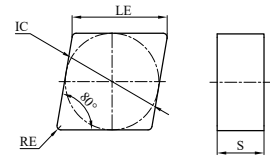



Ordering code	Edge	Dimension (mm)				PCBN Grade		
		LE	IC	S	RE	BKN225S	BHN225S	
	CNGN120404M-4	4	12.7	12.7	4.76	0.4	○	○
	CNGN120408LS-4	4	12.7	12.7	4.76	0.8	○	●
	CNGN120408M-4	4	12.7	12.7	4.76	0.8	○	○
	CNGN120412M-4	4	12.7	12.7	4.76	1.2	○	○
	CNGN120704M-4	4	12.7	12.7	7.94	0.4	○	○
	CNGN120708M-4	4	12.7	12.7	7.94	0.8	○	○
	CNGN120712M-4	4	12.7	12.7	7.94	1.2	●	●
	CNGN120716M-4	4	12.7	12.7	7.94	1.6	○	○

● Stock ○ Available Upon Order

**DN** □ □

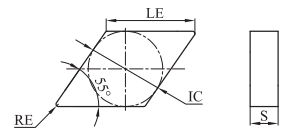
Rhombic 55° without Hole



Ordering code	Edge	Dimension (mm)				PCBN Grade		
		LE	IC	S	RE	BKN225S	BHN225S	
	DNGN110308M-4	4	9.525	9.525	3.18	0.8	○	○
	DNGN110312M-4	4	9.525	9.525	3.18	1.2	○	○

● Stock ○ Available Upon Order

## PCBN Insert (Negative)

**SN** □ □

Square 90° without Hole

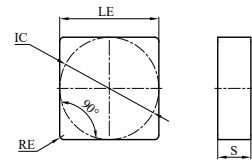

Ordering code	Edge	Dimension (mm)				PCBN Grade	
		LE	IC	S	RE	BKN225S	BHN225S
SNGN090404M-8	8	9.525	9.525	4.76	0.4	○	○
SNGN090408M-8	8	9.525	9.525	4.76	0.8	○	○
SNGN090412M-8	8	9.525	9.525	4.76	1.2	○	○
SNGN120404M-8	8	12.7	12.7	4.76	0.4	○	○
SNGN120408M-8	8	12.7	12.7	4.76	0.8	○	○
SNGN120412M-8	8	12.7	12.7	4.76	1.2	●	○
SNGN120708M-8	8	12.7	12.7	7.94	0.8	○	○
SNGN120712M-8	8	12.7	12.7	7.94	1.2	○	○
SNGN120716M-8	8	12.7	12.7	7.94	1.6	●	○
SNGN150708M-8	8	15.875	15.875	7.94	0.8	○	○
SNGN150712M-8	8	15.875	15.875	7.94	1.2	○	○

● Stock ○ Available Upon Order

**WN** □ □

Trigon 80° without Hole

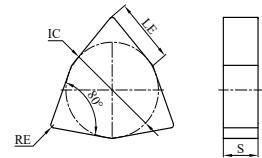

Ordering code	Edge	Dimension (mm)				PCBN Grade	
		LE	IC	S	RE	BKN225S	BHN225S
WNGN080404M-6	6	8.72	12.7	4.76	0.4	○	○
WNGN080408M-6	6	8.72	12.7	4.76	0.8	○	○
WNGN080412M-6	6	8.72	12.7	4.76	1.2	○	○
WNGN080416M-6	6	8.72	12.7	4.76	1.6	○	○
WNGN080604M-6	6	8.72	12.7	6.35	0.4	○	○
WNGN080608M-6	6	8.72	12.7	6.35	0.8	○	○
WNGN080612M-6	6	8.72	12.7	6.35	1.2	○	○
WNGN080616M-6	6	8.72	12.7	6.35	1.6	○	○

● Stock ○ Available Upon Order

PCBN Insert (Negative)

**RN** □ □

Round 360°without Hole

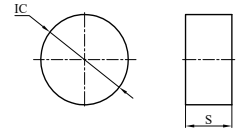

Ordering code	Edge	Dimension (mm)				PCBN Grade	
		LE	IC	S	RE	BKN225S	BHN225S
RNGN060300M	-	-	6	3.18	-	○	●
RNGN090300M	-	-	9.525	3.18	-	○	●
RNGN120400M	-	-	12.7	4.76	-	●	●
RNGN120400H	-	-	12.7	4.76	-	●	○
RNGN120700M	-	-	12.7	7.94	-	○	○
RNGN150700M	-	-	15.875	7.94	-	○	○
RNGN201000M	-	-	20	10	-	○	○



●Stock ○Available Upon Order

PCBN Insert (Positive)

**RC** □ □

Round 360°without Hole

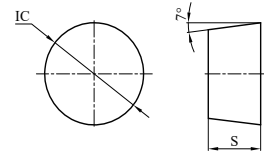

Ordering code	Edge	Dimension (mm)				PCBN Grade	
		LE	IC	S	RE	BKN225S	BHN225S
RCGN120700M	-	-	12.7	7.94	-		○
RCGN160700M	-	-	16	7.94	-		○



●Stock ○Available Upon Order

## PCD Insert (Positive)

**CC** □ □

Rhombic 80° with Hole

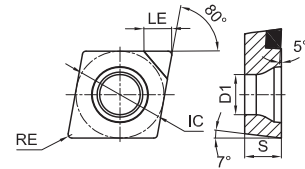

Ordering code	Edge	Dimension (mm)					PCD Grade
		LE	IC	S	D1	RE	
CCGW060202GB-1	1	2.5	6.35	2.38	2.8	0.2	●
CCGW060204GB-1	1	2.5	6.35	2.38	2.8	0.4	○
CCGW09T302GB-1	1	3	9.525	3.97	4.4	0.2	●
CCGW09T304GB-1	1	3	9.525	3.97	4.4	0.4	○
CCGW09T308GB-1	1	3	9.525	3.97	4.4	0.8	○
CCGW120404GB-1	1	3	12.7	4.76	5.5	0.4	●
CCGW120408GB-1	1	3	12.7	4.76	5.5	0.8	○
CCGW060202KB-1	1	2.5	6.35	2.38	2.8	0.2	●
CCGW060204KB-1	1	2.5	6.35	2.38	2.8	0.4	○
CCGW09T302KB-1	1	3	9.525	3.97	4.4	0.2	○
CCGW09T304KB-1	1	3	9.525	3.97	4.4	0.4	●
CCGW09T308KB-1	1	3	9.525	3.97	4.4	0.8	○



● Stock ○ Available Upon Order

**DC** □ □

Rhombic 55° with Hole

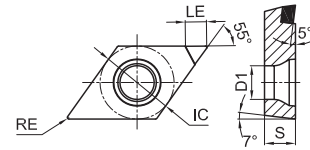

Ordering code	Edge	Dimension (mm)					PCD Grade
		LE	IC	S	D1	RE	
DCGW070202GB-1	1	2.5	6.35	2.38	2.8	0.2	○
DCGW070204GB-1	1	2.5	6.35	2.38	2.8	0.4	●
DCGW11T302GB-1	1	3	9.525	3.97	4.4	0.2	○
DCGW11T304GB-1	1	3	9.525	3.97	4.4	0.4	○
DCGW11T308GB-1	1	3	9.525	3.97	4.4	0.8	●
DCGW070202KB-1	1	2.5	6.35	2.38	2.8	0.2	○
DCGW070204KB-1	1	2.5	6.35	2.38	2.8	0.4	●
DCGW11T302KB-1	1	3	9.525	3.97	4.4	0.2	○
DCGW11T304KB-1	1	3	9.525	3.97	4.4	0.4	●
DCGW11T308KB-1	1	3	9.525	3.97	4.4	0.8	○



● Stock ○ Available Upon Order

PCD Insert (Positive)

**TC** □ □

Triangle 60° with Hole

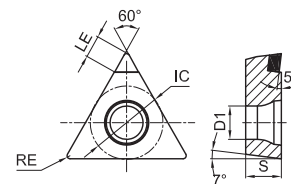

Ordering code	Edge	Dimension (mm)					PCD Grade
		LE	IC	S	D1	RE	
TCGW080202GB-1	1	2.5	4.76	2.38	2.34	0.2	○
TCGW080204GB-1	1	2.5	4.76	2.38	2.34	0.4	●
TCGW090202GB-1	1	2.5	5.56	2.38	2.8	0.2	○
TCGW090204GB-1	1	2.5	5.56	2.38	2.8	0.4	●
TCGW110302GB-1	1	2.5	6.35	3.18	3.4	0.2	○
TCGW110304GB-1	1	2.5	6.35	3.18	3.4	0.4	●
TCGW080202KB-1	1	2.5	4.76	2.38	2.34	0.2	○
TCGW080204KB-1	1	2.5	4.76	2.38	2.34	0.4	●
TCGW090202KB-1	1	2.5	5.56	2.38	2.8	0.2	○
TCGW090204KB-1	1	2.5	5.56	2.38	2.8	0.4	●
TCGW110302KB-1	1	2.5	6.35	3.18	3.4	0.2	○
TCGW110304KB-1	1	2.5	6.35	3.18	3.4	0.4	●



● Stock ○ Available Upon Order



## PCD Insert (Positive)

**TP**□□

Triangle 60° with Hole

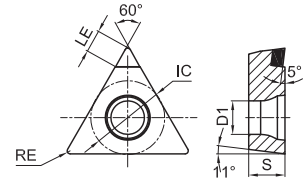

Ordering code	Edge	Dimension (mm)					PCD Grade
		LE	IC	S	D1	RE	
TPGW080202GB-1	1	2.5	4.76	2.38	2.34	0.2	○
TPGW080204GB-1	1	2.5	4.76	2.38	2.34	0.4	●
TPGW090202GB-1	1	2.5	5.56	2.38	2.8	0.2	○
TPGW090204GB-1	1	2.5	5.56	2.38	2.8	0.4	●
TPGW110302GB-1	1	2.5	6.35	3.18	3.4	0.2	○
TPGW110304GB-1	1	2.5	6.35	3.18	3.4	0.4	●
TPGW160402GB-1	1	3	9.525	4.76	4.4	0.2	○
TPGW160404GB-1	1	3	9.525	4.76	4.4	0.4	○
TPGW160408GB-1	1	3	9.525	4.76	4.4	0.8	●
TPGW080202KB-1	1	2.5	4.76	2.38	2.34	0.2	○
TPGW080204KB-1	1	2.5	4.76	2.38	2.34	0.4	●
TPGW090202KB-1	1	2.5	5.56	2.38	2.8	0.2	○
TPGW090204KB-1	1	2.5	5.56	2.38	2.8	0.4	●
TPGW110302KB-1	1	2.5	6.35	3.18	3.4	0.2	○
TPGW110304KB-1	1	2.5	6.35	3.18	3.4	0.4	●
TPGW160402KB-1	1	3	9.525	4.76	4.4	0.2	○
TPGW160404KB-1	1	3	9.525	4.76	4.4	0.4	●
TPGW160408KB-1	1	3	9.525	4.76	4.4	0.8	○



●Stock ○Available Upon Order

## PCD Insert (Positive)

**VC** □ □

Rhombic 35° with Hole

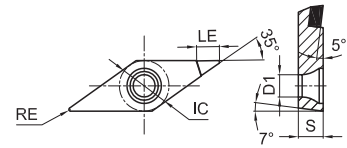

Ordering code	Edge	Dimension (mm)					PCD Grade
		LE	IC	S	D1	RE	
VCGW110302GB-1	1	3	6.35	3.18	2.8	0.2	○
VCGW110304GB-1	1	3	6.35	3.18	2.8	0.4	●
VCGW160402GB-1	1	3	9.525	4.76	4.4	0.2	○
VCGW160404GB-1	1	3	9.525	4.76	4.4	0.4	●
VCGW160408GB-1	1	3	9.525	4.76	4.4	0.8	○
VCGW110302KB-1	1	3	6.35	3.18	2.8	0.2	○
VCGW110304KB-1	1	3	6.35	3.18	2.8	0.4	●
VCGW160402KB-1	1	3	9.525	4.76	4.4	0.2	○
VCGW160404KB-1	1	3	9.525	4.76	4.4	0.4	●
VCGW160408KB-1	1	3	9.525	4.76	4.4	0.8	○



●Stock ○Available Upon Order

**RD** □ □

Round 360° with Hole

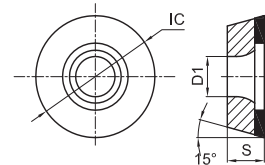

Ordering code	Edge	Dimension (mm)			PCD Grade
		IC	S	D1	
RDEW080300GN-1	1	8	3.18	2.94	○
RDEW100300GN-1	1	10	3.18	4.6	●
RDEW120400GN-1	1	12	4.76	4.4	○
RDEW160400GN-1	1	16	4.76	5.5	●



●Stock ○Available Upon Order

# Recommended Cutting Datas

## PCBN Insert

ISO	Workpiece Material	Hardness	Cutting Range	Application	Grade	Min-Optimum-Max		
						Vc(m/min)	ap(mm)	f(mm/rev)
<b>K</b>	Nodular Cast Iron	QT450~QT700	Finishing	General	BKC120P	150-300-500	0.10-0.20-0.50	0.05-0.12-0.3
	Alloy Cast Iron	≥HB200	Finishing	General	BKN115P	200-400-800	0.05-0.20-0.50	0.05-0.20-0.40
	Gray Cast Iron	HB200~230	Finishing	General	BKN115P	400-600-1500	0.05-0.20-0.50	0.05-0.20-0.40
	Grey Cast Iron	HB200~230	Finishing-Rough	General	BKN225Z BKN225S	400-600-1200	0.05-0.30-0.50	0.05-0.20-0.50
<b>S</b>	Powder Metallurgy	HRB50~90	Finishing	Continuous	BSN115P	50-150-300	0.05-0.20-0.50	0.05-0.12-0.30
<b>H</b>	Hardened Material	≥HRC50	Finishing	Continuous	BHC115P	120-150-220	0.05-0.10-0.20	0.05-0.10-0.20
	Hardened Material	≥HRC50	Finishing-Rough	General	BHC125P	100-130-180	0.05-0.10-0.50	0.05-0.10-0.20
	Hardened Material	≥HRC50	Finishing- Semi-finished	Intermittent	BHC135P	80-100-150	0.05-0.10-0.40	0.05-0.10-0.20
	Hardened Material	≥HRC50	Finishing- Semi-finished	Continuous	BHC210P	100-150-260	0.05-0.10-0.20	0.05-0.10-0.20
	Hardened Material	≥HRC50	Finishing- Semi-finished	Continuous	BHC215Z	120-150-230	0.05-0.10-0.20	0.05-0.10-0.15
	Hardened Material	≥HRC50	Finishing-Rough	General	BHC225P BHC225Z	100-140-200	0.05-0.10-0.50	0.05-0.10-0.20
	Hardened Material	≥HRC50	Finishing-Rough	General	BHN225S	100-150-190	0.05-0.10-0.50	0.05-0.10-0.20

## PCD Insert

ISO	Workpiece Material	Cutting Range	Application	Grade	Min-Optimum-Max		
					Vc(m/min)	ap(mm)	f(mm/rev)
<b>N</b>	Aluminum Alloy	Finishing	General	DNN125P	300-1200-3000	0.05-0.20-0.50	0.05-0.10-0.20
	Copper Alloy	Finishing	General	DNN125P	200-500-1000	0.05-0.40-2.00	0.05-0.10-0.20
	Plastics	Finishing	General	DNN125P	100-600-1000	0.10-0.40-2.00	0.05-0.10-0.40
	Wood and inorganic	Finishing	General	DNN125P	200-2000-4000	0.10-0.50-2.00	0.05-0.10-0.40
	Cemented Alloy	Finishing	General	DNN125P	10-20-30	0.05-0.20-0.50	0.05-0.10-0.20
	Graphite	Finishing	General	DNN125P	100-300-600	0.10-0.40-2.00	0.10-0.25-1.00

E

# TURNING TOOLHOLDERS



## Overview of Turning Toolholders

MCBNR/L	MCLNR/L	MDJNR/L	MDPNN	MDQNR/L
P142	P142	P143	P143	P144
				
MSBNR/L	MSKNR/L	MSSNR/L	MTENN	MTFNR/L
P144	P145	P145	P146	P146
				
MTGNR/L	MTJNR/L	MVJNR/L	MVQNR/L	MWLNR/L
P147	P147	P148	P148	P149
				
SCLCR/L	SDJCR/L	SSDCN	STGCR/L	SVJCR/L
P150	P150	P0151	P151	P152
				
SWLCR/L	SCLCR/L	SCKCR/L	SCLCR/L-A16	SDUCR/L
P153	P156	P156	P157	P157
				
SDQCR/L	SDXCR/L	SSKCR/L	STUCR/L	STWCR/L
P158	P158	P159	P159	P160
				
STFCR/L	SVUCR/L	SWLCR/L	SCLPR/L	STFPR/L
P160	P161	P161	P162	P162
				

## External Turning Toolholder Identification System

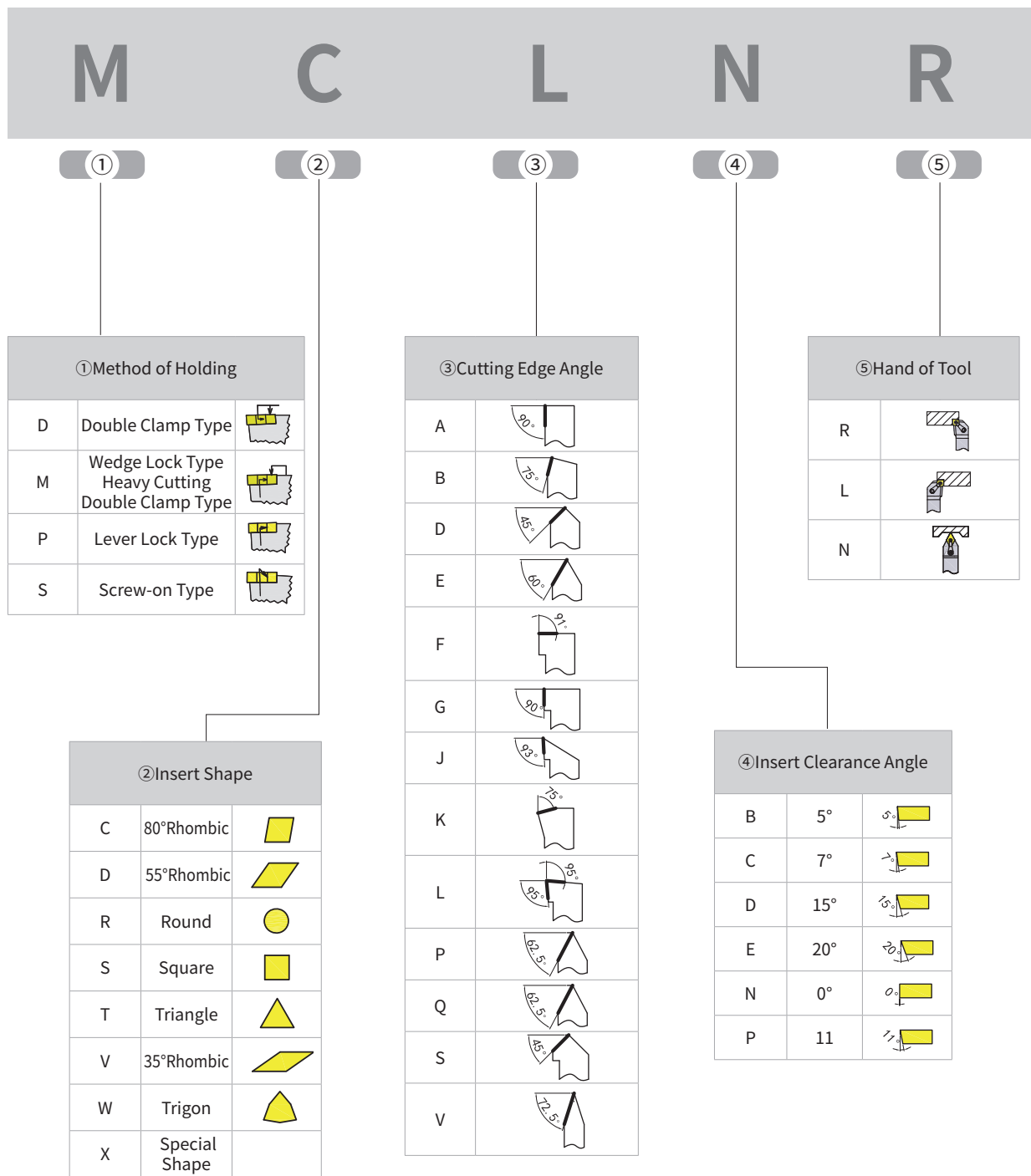

# 25

# 25

# M

# 12

⑥

⑦

⑧

⑨

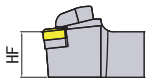
**⑥ Tool Height**

Code	Height
08	8
10	10
12	12
16	16
20	20
25	25
32	32

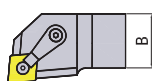
**⑦ Tool width**

Code	Width
08	8
10	10
12	12
16	16
20	20
25	25
32	32

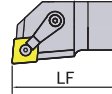
**⑧ Tool length**

Code	Width
E	70
F	80
H	100
K	125
M	150
P	170
Q	180
R	200

**⑨ Cutting Edge Length**

Tangent circle							
6.35	06	07	-	06	11	11	04
9.525	09	11	-	09	16	16	06
12.7	12	15	-	12	22	-	08
15.875	16	-	-	15	-	-	-
19.05	19	-	-	19	-	-	-
25.4	25	-	-	25	-	-	-
32	-	-	32	-	-	-	-

External Turning Toolholder (Negative)

# MCBNR/L

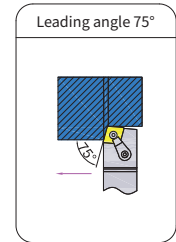
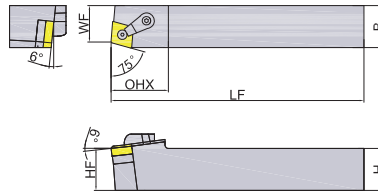

Ordering Code	Dimension (mm)						Insert	Shim	Pin	Clamp	Screw	Wrench	Weight (KG)	Stock	
	H	B	LF	OHX	HF	WF								R	L
MCBNR/L2020K12	20	20	125	32	20	17	CN**1204**	DCN1204MH	SPM060170H	CAM02H	SDM060200H	TH25LH TH30LH	0.4	●	○
MCBNR/L2525M12	25	25	150	32	25	22	CN**1204**	DCN1204MH	SPM060170H	CAM02H	SDM060250H	TH25LH TH30LH	0.78	●	●
MCBNR/L3232P12	32	32	170	32	32	27	CN**1204**	DCN1204MH	SPM060170H	CAM02H	SDM060280H	TH25LH TH30LH	1.37	●	●
MCBNR/L2525M16	25	25	150	42	25	22	CN**1606**	DCN1604MH	SPM080220FH	CAM03H	SDM060250H	TH30LH	0.78	●	○
MCBNR/L3232P19	32	32	170	42	32	27	CN**1906**	DCN1904MH	SPM100240FH	CAM05H	SDM080350FH	TH40LH	1.37	●	●

● Stock ○ Available upon Order

# MCLNR/L

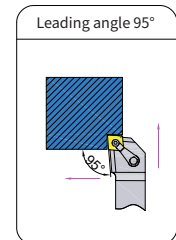
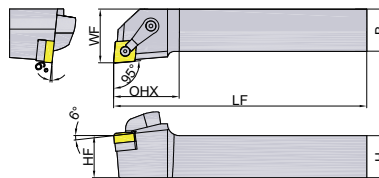

Ordering Code	Dimension (mm)						Insert	Shim	Pin	Clamp	Screw	Wrench	Weight (KG)	Stock	
	H	B	LF	OHX	HF	WF								R	L
MCLNR/L2020K12	20	20	125	32	20	25	CN**1204**	DCN1204MH	SPM060170H	CAM02H	SDM060200H	TH25LH TH30LH	0.4	●	●
MCLNR/L2525M12	25	25	150	32	25	32	CN**1204**	DCN1204MH	SPM060170H	CAM02H	SDM060250H	TH25LH TH30LH	0.78	●	●
MCLNR/L3232P12	32	32	170	32	32	40	CN**1204**	DCN1204MH	SPM060170H	CAM02H	SDM060280H	TH25LH TH30LH	1.37	●	●
MCLNR/L2525M16	25	25	150	42	25	32	CN**1606**	DCN1604MH	SPM080220FH	CAM03H	SDM060250H	TH30LH	0.78	●	●
MCLNR/L3232P16	32	32	170	42	32	40	CN**1606**	DCN1604MH	SPM080220FH	CAM03H	SDM060280H	TH30LH	1.37	●	●
MCLNR/L3232P19	32	32	170	42	32	40	CN**1906**	DCN1904MH	SPM100240FH	CAM05H	SDM080350FH	TH40LH	1.37	●	●

● Stock ○ Available upon Order



External Turning Toolholder (Negative)

# MDJNR/L

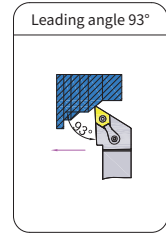
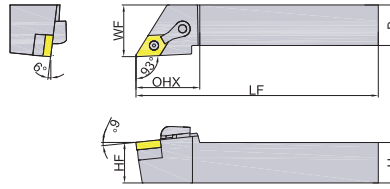

Ordering Code	Dimension (mm)						Insert	Shim	Pin	Clamp	Screw	Wrench	Weight (KG)	Stock	
	H	B	LF	OHX	HF	WF								R	L
MDJNR/L2020K11	20	20	125	32	20	25	DN**1104**	DDN1103MH	SPM050130H	CAM02H	SDM060200H	TH20LH TH30LH	0.4	●	●
MDJNR/L2020K1504	20	20	125	38	20	25	DN**1504**	DDN1504MH	SPM060170H	CAM03H	SDM060200H	TH25LH TH30LH	0.4	●	●
MDJNR/L2525M1504	25	25	150	38	25	32	DN**1504**	DDN1504MH	SPM060170H	CAM03H	SDM060250H	TH25LH TH30LH	0.78	●	●
MDJNR/L2525M1506	25	25	150	38	25	32	DN**1506**	DDN1504MH	SPM060190H	CAM03H	SDM060250H	TH25LH TH30LH	0.78	●	●
MDJNR/L3232P1506	32	32	170	38	32	40	DN**1506**	DDN1504MH	SPM060190H	CAM03H	SDM060280H	TH25LH TH30LH	1.37	●	●

● Stock ○ Available upon Order

# MDPNN

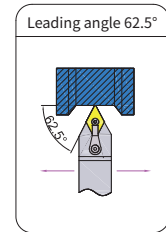
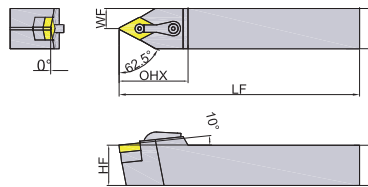

Ordering Code	Dimension (mm)						Insert	Shim	Pin	Clamp	Screw	Wrench	Weight (KG)	Stock	
	H	B	LF	OHX	HF	WF								R	L
MDPNN2020K11	20	20	125	35	20	10	DN**1104**	DDN1103MH	SPM050130H	CAM02H	SDM060200H	TH20LH TH30LH	0.38	●	
MDPNN2020K1504	20	20	125	42	20	10	DN**1504**	DDN1504MH	SPM060170H	CAM03H	SDM060200H	TH25LH TH30LH	0.38	●	
MDPNN2525M1504	25	25	150	42	25	12.5	DN**1504**	DDN1504MH	SPM060170H	CAM03H	SDM060250H	TH25LH TH30LH	0.76	●	
MDPNN2525M1506	25	25	150	42	25	12.5	DN**1506**	DDN1504MH	SPM060190H	CAM03H	SDM060250H	TH25LH TH30LH	0.76	●	
MDPNN3232P1506	32	32	170	42	32	16	DN**1506**	DDN1504MH	SPM060190H	CAM03H	SDM060280H	TH25LH TH30LH	1.35	●	

● Stock ○ Available upon Order

External Turning Toolholder (Negative)

# MDQNR/L

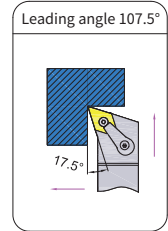
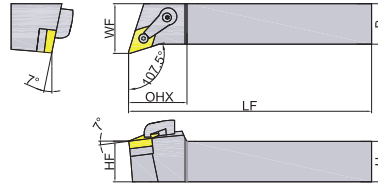

Ordering Code	Dimension (mm)						Insert	Shim	Pin	Clamp	Screw	Wrench	Weight (KG)	Stock	
	H	B	LF	OHX	HF	WF								R	L
MDQNR/L2020K11	20	20	125	32	20	25	DN**1104**	DDN1103MH	SPM050130H	CAM02H	SDM060200H	TH20LH TH30LH	0.4	●	○
MDQNR/L2020K1504	20	20	125	36	20	25	DN**1504**	DDN1504MH	SPM060170H	CAM03H	SDM060200H	TH25LH TH30LH	0.4	●	○
MDQNR/L2525M1504	25	25	150	36	25	32	DN**1504**	DDN1504MH	SPM060170H	CAM03H	SDM060250H	TH25LH TH30LH	0.78	●	○
MDQNR/L3232P1506	32	32	170	36	32	40	DN**1506**	DDN1504MH	SPM060190H	CAM03H	SDM060280H	TH25LH TH30LH	1.37	●	○

● Stock ○ Available upon Order

# MSBNR/L

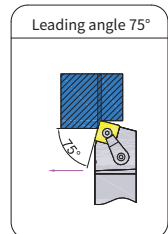
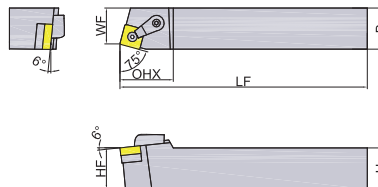

Ordering Code	Dimension (mm)						Insert	Shim	Pin	Clamp	Screw	Wrench	Weight (KG)	Stock	
	H	B	LF	OHX	HF	WF								R	L
MSBNR/L2020K12	20	20	125	32	20	17	SN**1204**	DSN1204MH	SPM060170H	CAM02H	SDM060200H	TH25LH TH30LH	0.4	●	○
MSBNR/L2525M12	25	25	150	32	25	22	SN**1204**	DSN1204MH	SPM060170H	CAM02H	SDM060250H	TH25LH TH30LH	0.78	●	○
MSBNR/L3232P12	32	32	170	32	32	27	SN**1204**	DSN1204MH	SPM060170H	CAM02H	SDM060280H	TH25LH TH30LH	1.37	●	○
MSBNR/L2525M15	25	25	150	42	25	22	SN**1506**	DSN1504MH	SPM080220FH	CAM03H	SDM060250H	TH30LH	0.78	●	○
MSBNR/L3232P19	32	32	170	42	32	27	SN**1906**	DSN1904MH	SPM100240FH	CAM05H	SDM080350FH	TH40LH	1.37	●	●

● Stock ○ Available upon Order

External Turning Toolholder (Negative)

# MSKNR/L

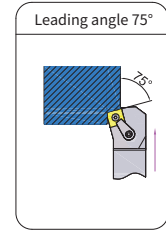
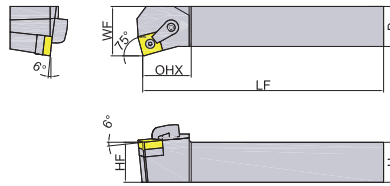

Ordering Code	Dimension (mm)						Insert	Shim	Pin	Clamp	Screw	Wrench	Weight (KG)	Stock	
	H	B	LF	OHX	HF	WF								R	L
MSKNR/L2020K12	20	20	125	32	20	25	SN**1204**	DSN1204MH	SPM060170H	CAM02H	SDM060200H	TH25LH TH30LH	0.4	●	○
MSKNR/L2525M12	25	25	150	32	25	32	SN**1204**	DSN1204MH	SPM060170H	CAM02H	SDM060250H	TH25LH TH30LH	0.78	●	○
MSKNR/L3232P12	32	32	170	32	32	40	SN**1204**	DSN1204MH	SPM060170H	CAM02H	SDM060280H	TH25LH TH30LH	1.37	●	○
MSKNR/L2525M15	25	25	150	42	25	32	SN**1506**	DSN1504MH	SPM080220FH	CAM03H	SDM060250H	TH30LH	0.78	●	○
MSKNR/L3232P19	32	32	170	42	32	40	SN**1906**	DSN1904MH	SPM100240FH	CAM05H	SDM080350FH	TH40LH	1.37	●	○

● Stock ○ Available upon Order

# MSSNR/L

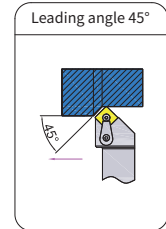
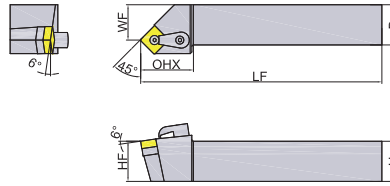

Ordering Code	Dimension (mm)						Insert	Shim	Pin	Clamp	Screw	Wrench	Weight (KG)	Stock	
	H	B	LF	OHX	HF	WF								R	L
MSSNR/L2020K12	20	20	125	32	20	17	SN**1204**	DSN1204MH	SPM060170H	CAM02H	SDM060200H	TH25LH TH30LH	0.39	●	●
MSSNR/L2525M12	25	25	150	32	25	22	SN**1204**	DSN1204MH	SPM060170H	CAM02H	SDM060250H	TH25LH TH30LH	0.77	●	●
MSSNR/L3232P12	32	32	170	32	32	27	SN**1204**	DSN1204MH	SPM060170H	CAM02H	SDM060280H	TH25LH TH30LH	1.36	●	○
MSSNR/L2525M15	25	25	150	42	25	22	SN**1506**	DSN1504MH	SPM080220FH	CAM03H	SDM060250H	TH30LH	0.77	●	○
MSSNR/L3232P19	32	32	170	42	32	27	SN**1906**	DSN1904MH	SPM100240FH	CAM05H	SDM080350FH	TH40LH	1.36	●	●

● Stock ○ Available upon Order

External Turning Toolholder (Negative)

# MTENN

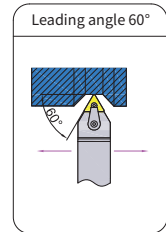
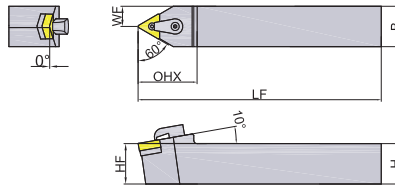

Ordering Code	Dimension (mm)						Insert	Shim	Pin	Clamp	Screw	Wrench	Weight (KG)	Stock
	H	B	LF	OHX	HF	WF								
MTENN2020K16	20	20	125	32	20	10	TN**1604**	DTN1603MH	SPM050130H	CAM02H	SDM060200H	TH20LH TH30LH	0.38	●
MTENN2525M16	25	25	150	32	25	12.5	TN**1604**	DTN1603MH	SPM050130H	CAM02H	SDM060250H	TH20LH TH30LH	0.76	●
MTENN3232P16	32	32	170	32	32	16	TN**1604**	DTN1603MH	SPM050130H	CAM02H	SDM060280H	TH20LH TH30LH	1.35	○
MTENN3232P22	32	32	170	38	32	16	TN**2204**	DTN2204MH	SPM060170H	CAM02H	SDM060280H	TH25L H TH30LH	1.35	●

● Stock ○ Available upon Order

# MTFNR/L

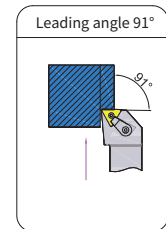
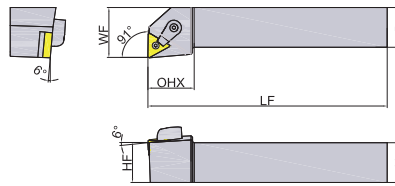

Ordering Code	Dimension (mm)						Insert	Shim	Pin	Clamp	Screw	Wrench	Weight (KG)	Stock	
	H	B	LF	OHX	HF	WF								R	L
MTFNR/L2020K16	20	20	125	32	20	25	TN**1604**	DTN1603MH	SPM050130H	CAM02H	SDM060250H	TH20LH TH30LH	0.4	●	○
MTFNR/L2525M16	25	25	150	32	25	32	TN**1604**	DTN1603MH	SPM050130H	CAM02H	SDM060250H	TH20LH TH30LH	0.78	●	○
MTFNR/L3232P16	32	32	170	32	32	40	TN**1604**	DTN1603MH	SPM050130H	CAM02H	SDM060280H	TH20LH TH30LH	1.37	●	○
MTFNR/L3232P22	32	32	170	38	32	40	TN**2204**	DTN2204MH	SPM060170H	CAM02H	SDM060280H	TH25L H TH30LH	1.37	●	○

● Stock ○ Available upon Order

External Turning Toolholder (Negative)

# MTGNR/L

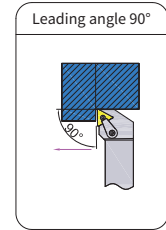
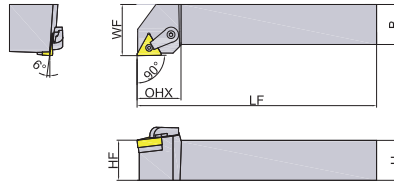

Ordering Code	Dimension (mm)						Insert	Shim	Pin	Clamp	Screw	Wrench	Weight (KG)	Stock	
	H	B	LF	OHX	HF	WF								R	L
MTGNR/L2020K16	20	20	125	32	20	25	TN**1604**	DTN1603MH	SPM050130H	CAM02H	SDM060250H	TH20LH TH30LH	0.4	●	○
MTGNR/L2525M16	25	25	150	32	25	32	TN**1604**	DTN1603MH	SPM050130H	CAM02H	SDM060250H	TH20LH TH30LH	0.78	●	●
MTGNR/L3232P16	32	32	170	32	32	40	TN**1604**	DTN1603MH	SPM050130H	CAM02H	SDM060280H	TH20LH TH30LH	1.37	●	○
MTGNR/L3232P22	32	32	170	38	32	40	TN**2204**	DTN2204MH	SPM060170H	CAM02H	SDM060280H	TH25L H TH30LH	1.37	●	○

● Stock ○ Available upon Order

# MTJNR/L

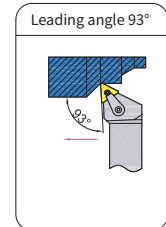
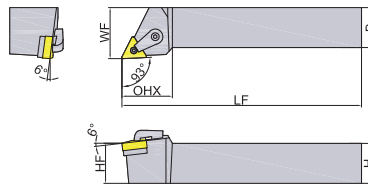

Ordering Code	Dimension (mm)						Insert	Shim	Pin	Clamp	Screw	Wrench	Weight (KG)	Stock	
	H	B	LF	OHX	HF	WF								R	L
MTJNR/L2020K16	20	20	125	32	20	25	TN**1604**	DTN1603MH	SPM050130H	CAM02H	SDM060250H	TH20LH TH30LH	0.4	●	●
MTJNR/L2525M16	25	25	150	32	25	32	TN**1604**	DTN1603MH	SPM050130H	CAM02H	SDM060250H	TH20LH TH30LH	0.78	●	●
MTJNR/L3232P16	32	32	170	32	32	40	TN**1604**	DTN1603MH	SPM050130H	CAM02H	SDM060280H	TH20LH TH30LH	1.37	●	○
MTJNR/L3232P22	32	32	170	38	32	40	TN**2204**	DTN2204MH	SPM060170H	CAM02H	SDM060280H	TH25LH TH30LH	1.37	●	●

● Stock ○ Available upon Order

External Turning Toolholder (Negative)

# MVJNR/L

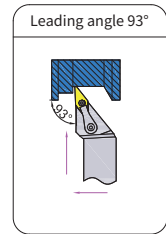
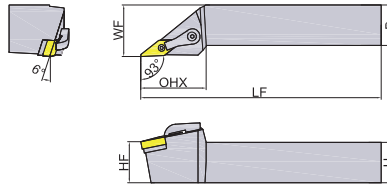

Ordering Code	Dimension (mm)						Insert	Shim	Pin	Clamp	Screw	Wrench	Weight (KG)		Stock	
	H	B	LF	OHX	HF	WF							R	L		
MVJNR/L2020K16	20	20	125	42	20	25	VN**1604**	DVN1603MH	SPM050130H	CAM04H	SDM060250H	TH20LH TH30LH	0.4	●	●	
MVJNR/L2525M16	25	25	150	42	25	32	VN**1604**	DVN1603MH	SPM050130H	CAM04H	SDM060250H	TH20LH TH30LH	0.78	●	●	
MVJNR/L3232P16	32	32	170	42	32	40	VN**1604**	DVN1603MH	SPM050130H	CAM04H	SDM060280H	TH20LH TH30LH	1.37	●	●	

● Stock ○ Available upon Order

# MVQNR/L

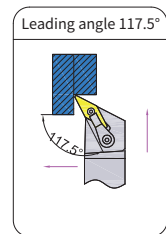
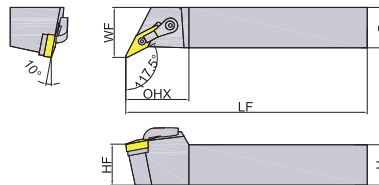

Ordering Code	Dimension (mm)						Insert	Shim	Pin	Clamp	Screw	Wrench	Weight (KG)		Stock	
	H	B	LF	OHX	HF	WF							R	L		
MVQNR/L2020K16	20	20	125	42	20	25	VN**1604**	DVN1603MH	SPM050130H	CAM02H	SDM060250H	TH20LH TH30LH	0.4	●	●	
MVQNR/L2525M16	25	25	150	42	25	32	VN**1604**	DVN1603MH	SPM050130H	CAM02H	SDM060250H	TH20LH TH30LH	0.78	●	●	
MVQNR/L3232P16	32	32	170	42	32	40	VN**1604**	DVN1603MH	SPM050130H	CAM02H	SDM060280H	TH20LH TH30LH	1.37	●	●	

● Stock ○ Available upon Order

External Turning Toolholder (Negative)

# MWLNR/L

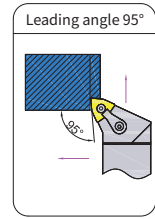
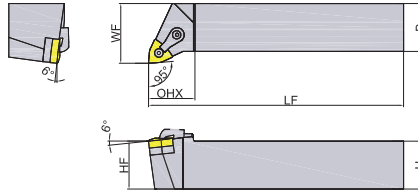

Ordering Code	Dimension (mm)						Insert	Shim	Pin	Clamp	Screw	Wrench	Weight (KG)	Stock	
	H	B	LF	OHX	HF	WF								R	L
MWLNR/L2525M06T3	25	25	150	28	25	32	WN**06T3**	DWN0603MH	SPM050130H	CAM01H	SDM050200H	TH20LH TH30LH	0.78	●	●
MWLNR/L2020K0604	20	20	125	28	20	25	WN**0604**	DWN0603MH	SPM050130H	CAM01H	SDM050200H	TH20LH TH30LH	0.4	●	●
MWLNR2525M0604	20	20	150	28	25	32	WN**0604**	DWN0603MH	SPM050130H	CAM01H	SDM050200H	TH20LH TH30LH	0.78	●	●
MWLNR/L2020K08	20	20	125	32	20	25	WN**0804**	DWN0804MH	SPM060170H	CAM02H	SDM060200H	TH25LH TH30LH	0.4	●	●
MWLNR/L2525M08	25	25	150	32	25	32	WN**0804**	DWN0804MH	SPM060170H	CAM02H	SDM060250H	TH25LH TH30LH	0.4	●	●
MWLNR/L3232P08	32	32	170	32	32	40	WN**0804**	DWN0804MH	SPM060170H	CAM02H	SDM060280H	TH25LH TH30LH	1.37	●	●

● Stock ○ Available upon Order

External Turning Toolholder (Positive)

# SCLCR/L

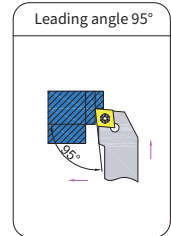
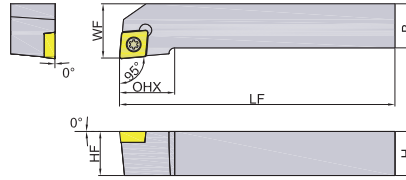
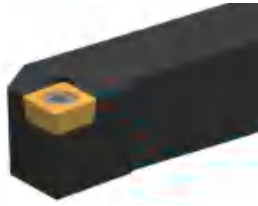

Ordering Code	Dimension (mm)						Insert	Screw	Wrench	Weight (KG)	Stock	
	H	B	LF	OHX	HF	WF					R	L
SCLCR/L1010F06	10	10	80	12	10	12	CC**0602**	SI60M025060-03510H	TT08PH	0.06	●	●
SCLCR/L1212H09	12	12	100	16	12	16	CC**09T3**	SI60M040100-05812H	TT15PH	0.11	●	○
SCLCR/L1616H09	16	16	100	16	16	20	CC**09T3**	SI60M040100-05812H	TT15PH	0.2	●	●
SCLCR/L2020K09	20	20	125	16	20	25	CC**09T3**	SI60M040100-05812H	TT15PH	0.4	●	●
SCLCR/L2525M12	25	25	150	20	25	32	CC**1204**	SI60M050120-07012H	TT20PH	0.78	●	●

● Stock ○ Available upon Order

# SDJCR/L

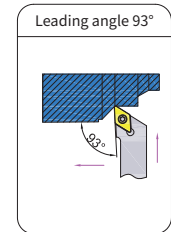
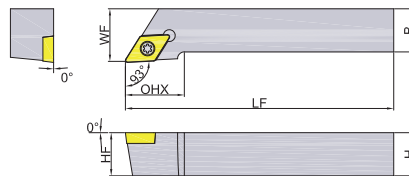

Ordering Code	Dimension (mm)						Insert	Screw	Wrench	Weight (KG)	Stock	
	H	B	LF	OHX	HF	WF					R	L
SDJCR/L1010F07	10	10	80	15	10	12	DC**0702**	SI60M025060-03510H	TT08PH	0.06	●	●
SDJCR1212H07	12	12	100	15	12	16	DC**0702**	SI60M025060-03510H	TT08PH	0.11	●	
SDJCR/L1616H11	16	16	100	20	16	20	DC**11T3**	SI60M040100-05812H	TT15PH	0.2	●	●
SDJCR/L2020K11	20	20	125	20	20	25	DC**11T3**	SI60M040100-05812H	TT15PH	0.4	●	●
SDJCR/L2525M11	25	25	150	20	25	32	DC**11T3**	SI60M040100-05812H	TT15PH	0.78	●	●

● Stock ○ Available upon Order



External Turning Toolholder (Positive)

# SSDCN

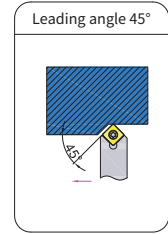
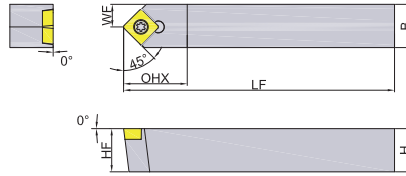

Ordering Code	Dimension (mm)						Insert	Screw	Wrench	Weight (KG)	Stock
	H	B	LF	OHX	HF	WF					
SSDCN1212H09	12	12	80	15	12	6	SC**09T3**	SI60M040100-05812H	TT15PH	0.1	●
SSDCN1616H09	16	16	100	15	16	8	SC**09T3**	SI60M040100-05812H	TT15PH	0.19	●
SSDCN2020K09	20	20	125	15	20	10	SC**09T3**	SI60M040100-05812H	TT15PH	0.39	○
SSDCN2525M12	25	25	150	20	25	12.5	SC**1204**	SI60M050120-07012H	TT20PH	0.77	●

●Stock ○Available upon Order

# STGCR/L

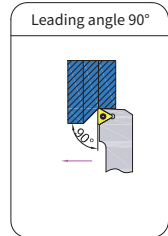
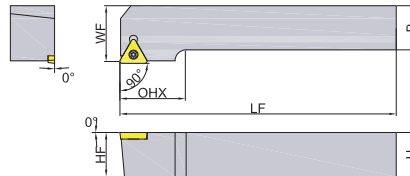

Ordering Code	Dimension (mm)						Insert	Screw	Wrench	Weight (KG)	Stock	
	H	B	LF	OHX	HF	WF					R	L
STGCR1010F09	10	10	80	12	10	12	TC**0902**	SI60M022060-03008H	TT06PH	0.06	●	
STGCR/L1212H11	12	12	100	16	12	16	TC**1102**	SI60M025060-03510H	TT08PH	0.11	●	○
STGCR/L1616H11	16	16	100	20	16	20	TC**1102**	SI60M025060-03510H	TT08PH	0.2	●	●
STGCR/L2020K16	20	20	125	25	20	25	TC**16T3**	SI60M040100-05812H	TT15PH	0.4	●	●
STGCR/L2525M16	25	25	150	25	25	32	TC**16T3**	SI60M040100-05812H	TT15PH	0.78	●	●

●Stock ○Available upon Order

External Turning Toolholder (Positive)



# SVJCR/L

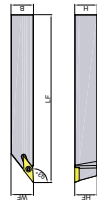

SVJCR



Leading angle 93°



Ordering Code	Dimension (mm)						Insert	Screw 	Wrench 	Weight (KG)	Stock	
	H	B	LF	OHX	HF	WF					R	L
SVJCR1212H11	12	12	100	25	12	16	VC**1103**	SI60M025060-03510H	TT08PH	0.1	●	
SVJCR/L1616H11	16	16	100	25	16	20	VC**1103**	SI60M025060-03510H	TT08PH	0.19	●	●
SVJCR/L2020K16	20	20	125	35	20	25	VC**1604**	SI60M040100-05812H	TT15PH	0.39	●	●
SVJCR/L2525M16	25	25	150	35	25	32	VC**1604**	SI60M040100-05812H	TT15PH	0.77	●	●

● Stock ○ Available upon Order

## External Turning Toolholder (Positive)

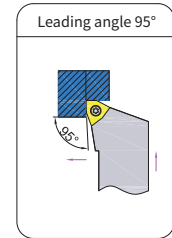
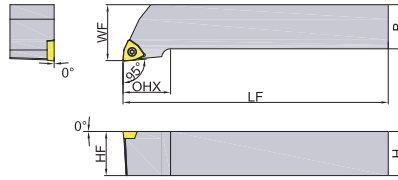
# SWLCR/L



Ordering Code	Dimension (mm)						Insert	Screw 	Wrench 	Weight (KG)	Stock	
	H	B	LF	OHX	HF	WF					R	L
SWLCR/L1212H06	12	12	100	15	12	16	WC**06T3**	SI60M040100-05812H	TT15PH	0.11	●	●
SWLCR/L1616H06	16	16	100	15	16	20	WC**06T3**	SI60M040100-05812H	TT15PH	0.2	●	●
SWLCR/L2020K06	20	20	125	15	20	25	WC**06T3**	SI60M040100-05812H	TT15PH	0.4	●	●
SWLCR/L2525M06	25	25	150	20	25	32	WC**06T3**	SI60M040100-05812H	TT15PH	0.78	●	●

● Stock ○ Available upon Order

## Internal Turning Toolholders Identification System

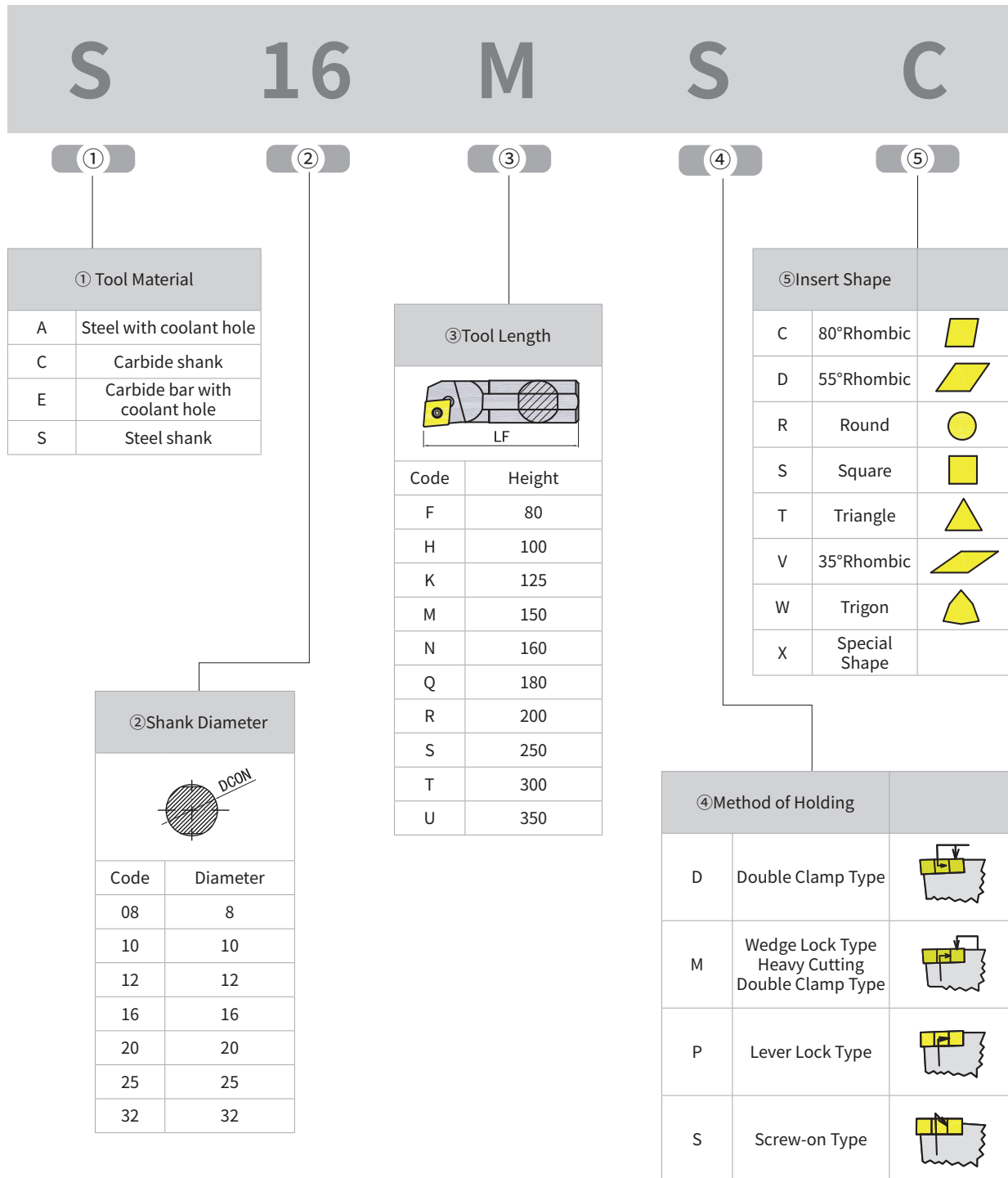

# L C R 09

⑥
⑦
⑧
⑨

**⑥ Cutting Edge Angle**

K	
L	
F	
U	
Q	
W	

**⑦ Insert Clearance Angle**

B	5°	
C	7°	
D	15°	
E	20°	
N	0°	
P	11°	

**⑧ Hand of Tool**

R	
L	

**⑨ Cutting Edge Length(mm)**

Tangent circle							
6.35	06	07	-	06	11	11	04
9.525	09	11	-	09	16	16	06
12.7	12	15	-	12	22	-	08
15.875	16	-	-	15	-	-	-
19.05	19	-	-	19	-	-	-
25.4	25	-	-	25	-	-	-
32	-	-	32	-	-	-	-

Internal Turning Toolholder

# SCLCR/L

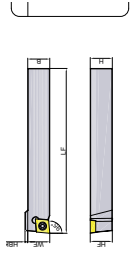

Leading angle 95°

Ordering Code	Dimension (mm)							Insert	Screw	Wrench	Weight (KG)	Stock	
	DMIN1	DCON	WF	LF	OHN	H	$\alpha^\circ$					R	L
S08K-SCLCR/L06	10	8	5.5	125	12	7	13	CC**0602**	SI60M025060-03510H	TT08PH	0.05	●	●
S10K-SCLCR/L06	12	10	6.5	125	15	9	12	CC**0602**	SI60M025060-03510H	TT08PH	0.08	●	●
S12M-SCLCR/L06	16	12	8	150	18	11	10	CC**0602**	SI60M025060-03510H	TT08PH	0.14	●	●
S12M-SCLCR/L09	16	12	8	150	18	11	12	CC**09T3**	SI60M040100-05812H	TT15PH	0.14	●	●
S16Q-SCLCR/L09	20	16	10	180	24	15	10	CC**09T3**	SI60M040100-05812H	TT15PH	0.29	●	●
S20R-SCLCR/L09	25	20	12	200	30	18	8	CC**09T3**	SI60M040100-05812H	TT15PH	0.5	●	●
S25S-SCLCR/L09	32	25	16	250	38	23	6	CC**09T3**	SI60M040100-05812H	TT15PH	0.98	●	●
S25S-SCLCR/L12	32	25	16	250	38	23	8	CC**1204**	SI60M050120-07012H	TT20PH	0.98	●	●

● Stock ○ Available upon Order

# SCKCR/L

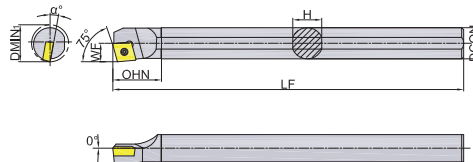

Leading angle 75°

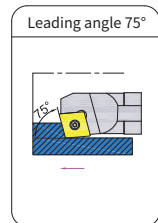

Ordering Code	Dimension (mm)							Insert	Screw	Wrench	Weight (KG)	Stock	
	DMIN1	DCON	WF	LF	OHN	H	$\alpha^\circ$					R	L
S08K-SCKCR/L06	10	8	5.5	125	12	7	13	CC**0602**	SI60M025060-03510H	TT08PH	0.05	●	○
S10K-SCKCR/L06	12	10	6.5	125	15	9	12	CC**0602**	SI60M025060-03510H	TT08PH	0.08	●	○
S12M-SCKCR/L06	16	12	8	150	18	11	10	CC**0602**	SI60M025060-03510H	TT08PH	0.14	○	○
S12M-SCKCR/L09	16	12	8	150	18	11	12	CC**09T3**	SI60M040100-05812H	TT15PH	0.14	●	○
S16Q-SCKCR/L09	20	16	10	180	24	15	10	CC**09T3**	SI60M040100-05812H	TT15PH	0.29	●	○
S20R-SCKCR/L09	25	20	12	200	30	18	8	CC**09T3**	SI60M040100-05812H	TT15PH	0.5	○	○
S25S-SCKCR/L09	32	25	16	250	38	23	6	CC**09T3**	SI60M040100-05812H	TT15PH	0.98	●	○

● Stock ○ Available upon Order

## Internal Turning Toolholder

# SCLCR/L-A16

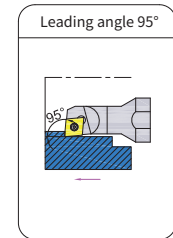
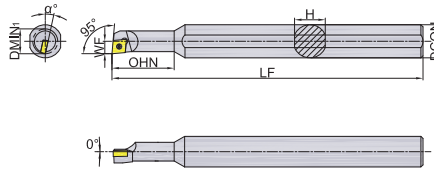

Ordering Code	Dimension (mm)							Insert	Screw	Wrench	Weight (KG)	Stock	
	DMIN1	DCON	WF	LF	OHN	H	$\alpha^\circ$					R	L
S07M-SCLCR/L06-A16	9	16	4.25	150	18	15	15	CC**0602**	SI60M025060-03510H	TT08PH	0.22	●	○
S08M-SCLCR/L06-A16	10	16	5	150	20	15	13	CC**0602**	SI60M025060-03510H	TT08PH	0.22	●	○
S10M-SCLCR/L06-A16	13	16	6	150	26	15	12	CC**0602**	SI60M025060-03510H	TT08PH	0.22	●	●
S12M-SCLCR/L06-A16	15	16	7	150	28	15	10	CC**0602**	SI60M025060-03510H	TT08PH	0.22	●	○

● Stock ○ Available upon Order

# SDUCR/L

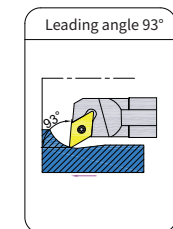
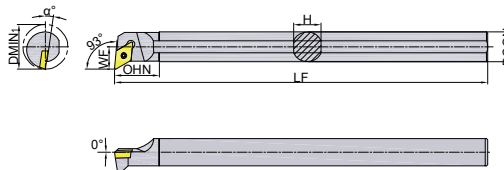

Ordering Code	Dimension (mm)							Insert	Screw	Wrench	Weight (KG)	Stock	
	DMIN1	DCON	WF	LF	OHN	H	$\alpha^\circ$					R	L
S10K-SDUCR/L07	12	10	7	125	15	9	10	DC**0702**	SI60M025060-03510H	TT08PH	0.08	●	●
S12M-SDUCR/L07	16	12	9	150	18	11	8	DC**0702**	SI60M025060-03510H	TT08PH	0.14	●	●
S16Q-SDUCR/L07	20	16	11	180	24	15	6	DC**0702**	SI60M025060-03510H	TT08PH	0.29	●	●
S16Q-SDUCR/L11	20	16	11	180	24	15	6	DC**11T3**	SI60M040100-05812H	TT15PH	0.29	●	●
S20R-SDUCR/L11	25	20	13	200	30	18	6	DC**11T3**	SI60M040100-05812H	TT15PH	0.5	●	●
S25S-SDUCR/L11	32	25	16	250	38	23	4	DC**11T3**	SI60M040100-05812H	TT15PH	0.98	●	●

● Stock ○ Available upon Order

Internal Turning Toolholder

# SDQCR/L

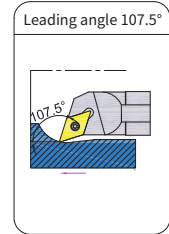
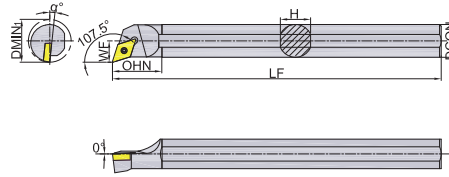

Ordering Code	Dimension (mm)							Insert	Screw	Wrench	Weight (KG)	Stock	
	DMIN1	DCON	WF	LF	OHN	H	$\alpha^\circ$					R	L
S10K-SDQCR/L07	12	10	7	125	15	9	10	DC**0702**	SI60M025060-03510H	TT08PH	0.08	●	○
S12M-SDQCR/L07	16	12	9	150	18	11	8	DC**0702**	SI60M025060-03510H	TT08PH	0.14	●	○
S16Q-SDQCR/L07	20	16	11	180	24	15	6	DC**0702**	SI60M025060-03510H	TT08PH	0.29	●	○
S16Q-SDQCR/L11	20	16	11	180	24	15	6	DC**11T3**	SI60M040100-05812H	TT15PH	0.29	●	●
S20R-SDQCR/L11	25	20	13	200	30	18	6	DC**11T3**	SI60M040100-05812H	TT15PH	0.5	●	○
S25S-SDQCR/L11	32	25	16	250	38	23	4	DC**11T3**	SI60M040100-05812H	TT15PH	0.98	●	●

● Stock ○ Available upon Order

# SDXCR/L

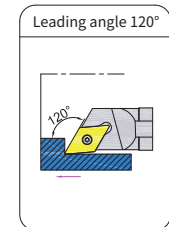
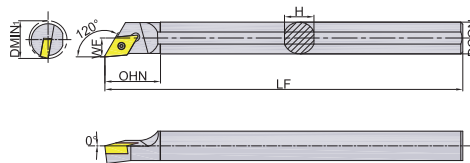

Ordering Code	Dimension (mm)							Insert	Screw	Wrench	Weight (KG)	Stock	
	DMIN1	DCON	WF	LF	OHN	H	$\alpha^\circ$					R	L
S08K-SDXCR/L07	10	8	5.5	125	12	7	12	DC**0702**	SI60M025060-03510H	TT08PH	0.05	●	○
S10K-SDXCR/L07	12	10	6.5	125	15	9	10	DC**0702**	SI60M025060-03510H	TT08PH	0.08	●	○
S12M-SDXCR/L07	16	12	8	150	18	11	8	DC**0702**	SI60M025060-03510H	TT08PH	0.14	●	○
S16Q-SDXCR/L07	20	16	10	180	24	15	6	DC**0702**	SI60M040100-05812H	TT08PH	0.29	●	○
S20R-SDXCR/L11	25	20	12	200	30	18	6	DC**11T3**	SI60M040100-05812H	TT15PH	0.5	●	●
S25S-SDXCR/L11	32	25	14	250	38	23	4	DC**11T3**	SI60M040100-05812H	TT15PH	0.98	●	○

● Stock ○ Available upon Order



Internal Turning Toolholder

# SSKCR/L

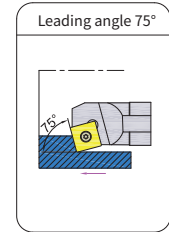
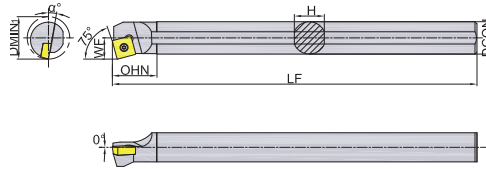

Ordering Code	Dimension (mm)							Insert	Screw	Wrench	Weight (KG)	Stock	
	DMIN1	DCON	WF	LF	OHN	H	$\alpha^\circ$					R	L
S12M-SSKCR/L09	16	12	9	150	18	11	10	SC**09T3**	SI60M040100-05812H	TT15PH	0.14	<input type="radio"/>	<input type="radio"/>
S16Q-SSKCR/L09	20	16	11	180	24	15	10	SC**09T3**	SI60M040100-05812H	TT15PH	0.29	<input checked="" type="radio"/>	<input type="radio"/>
S20R-SSKCR/L09	25	20	13	200	30	18	8	SC**09T3**	SI60M040100-05812H	TT15PH	0.5	<input checked="" type="radio"/>	<input type="radio"/>
S25S-SSKCR/L12	32	25	17	250	38	23	6	SC**1204**	SI60M050120-07012H	TT20PH	0.98	<input type="radio"/>	<input type="radio"/>

●Stock ○Available upon Order

# STUCR/L

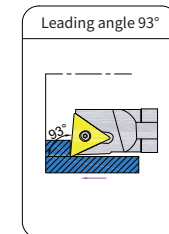
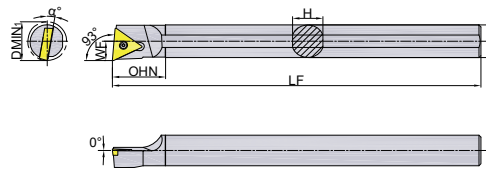

Ordering Code	Dimension (mm)							Insert	Screw	Wrench	Weight (KG)	Stock	
	DMIN1	DCON	WF	LF	OHN	H	$\alpha^\circ$					R	L
S08K-STUCR/L09	10	8	5.5	125	12	7	15	TC**0902**	SI60M022060-03008H	TT06PH	0.05	<input checked="" type="radio"/>	<input type="radio"/>
S10K-STUCR/L09	12	10	6.5	125	15	9	13	TC**0902**	SI60M022060-03008H	TT06PH	0.08	<input checked="" type="radio"/>	<input type="radio"/>
S10K-STUCR/L11	12	10	6.5	125	15	9	12	TC**1102**	SI60M025060-03510H	TT08PH	0.08	<input checked="" type="radio"/>	<input type="radio"/>
S12M-STUCR/L11	16	12	8	150	18	11	10	TC**1102**	SI60M025060-03510H	TT08PH	0.14	<input checked="" type="radio"/>	<input type="radio"/>
S16Q-STUCR/L11	20	16	10	180	24	15	8	TC**1102**	SI60M025060-03510H	TT08PH	0.29	<input checked="" type="radio"/>	<input type="radio"/>
S20R-STUCR11	25	20	12	200	30	18	6	TC**1102**	SI60M025060-03510H	TT08PH	0.5	<input checked="" type="radio"/>	<input type="radio"/>
S20R-STUCR/L16	25	20	12	200	30	18	4	TC**16T3**	SI60M040100-05812H	TT15PH	0.5	<input checked="" type="radio"/>	<input type="radio"/>
S25S-STUCR16	32	25	16	250	38	23	6	TC**16T3**	SI60M040100-05812H	TT15PH	0.98	<input checked="" type="radio"/>	<input type="radio"/>

●Stock ○Available upon Order

Internal Turning Toolholder

# STWCR/L

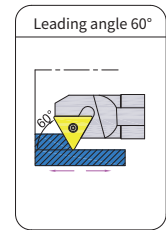

Ordering Code	Dimension (mm)							Insert	Screw	Wrench	Weight (KG)	Stock	
	DMIN1	DCON	WF	LF	OHN	H	$\alpha^\circ$					R	L
S08K-STWCR/L09	10	8	6	125	12	7	15	TC**0902**	SI60M022060-03008H	TT06PH	0.05	●	○
S10K-STWCR/L11	12	10	8	125	15	9	10	TC**1102**	SI60M025060-03510H	TT08PH	0.08	●	○
S12M-STWCR/L11	16	12	9	150	18	11	8	TC**1102**	SI60M025060-03510H	TT08PH	0.14	●	○
S16Q-STWCR/L11	20	16	11	180	24	15	6	TC**1102**	SI60M025060-03510H	TT08PH	0.29	○	○
S20R-STWCR11	25	20	13	200	30	18	4	TC**1102**	SI60M025060-03510H	TT08PH	0.5	○	○
S20R-STWCR/L16	25	20	15	200	30	18	8	TC**16T3**	SI60M040100-05812H	TT15PH	0.5	○	○
S25S-STWCR/L16	32	25	17	250	38	23	6	TC**16T3**	SI60M040100-05812H	TT15PH	0.98	●	○

● Stock ○ Available upon Order

# STFCR/L

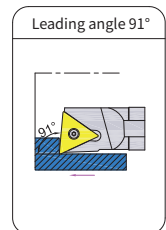
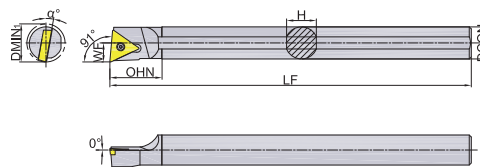

Ordering Code	Dimension (mm)							Insert	Screw	Wrench	Weight (KG)	Stock	
	DMIN1	DCON	WF	LF	OHN	H	$\alpha^\circ$					R	L
S08K-STFCR/L09	10	8	5.5	125	12	7	15	TC**0902**	SI60M022060-03008H	TT06PH	0.05	●	○
S10K-STFCR/L09	12	10	6.5	125	15	9	13	TC**0902**	SI60M022060-03008H	TT06PH	0.08	●	●
S12M-STFCR/L09	16	12	8	150	18	11	10	TC**0902**	SI60M022060-03008H	TT06PH	0.14	●	○
S12M-STFCR/L11	16	12	8	150	18	11	10	TC**1102**	SI60M025060-03510H	TT08PH	0.14	●	●
S16Q-STFCR/L11	20	16	10	180	24	15	8	TC**1102**	SI60M025060-03510H	TT08PH	0.29	●	●
S20R-STFCR/L11	25	20	12	200	30	18	6	TC**1102**	SI60M025060-03510H	TT08PH	0.5	●	●
S20R-STFCR/L16	25	20	12	200	30	18	8	TC**16T3**	SI60M040100-05812H	TT15PH	0.5	●	○
S25S-STFCR/L16	32	25	16	250	18	23	6	TC**16T3**	SI60M040100-05812H	TT15PH	0.98	●	●

● Stock ○ Available upon Order

## Internal Turning Toolholder

# SVUCR/L

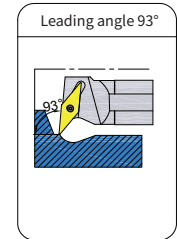
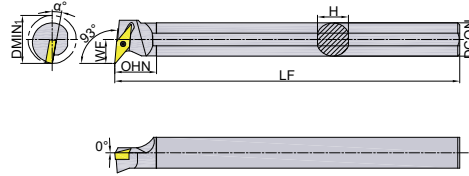

Ordering Code	Dimension (mm)							Insert	Screw	Wrench	Weight (KG)	Stock	
	DMIN1	DCON	WF	LF	OHN	H	$\alpha^\circ$					R	L
S16Q-SVUCR/L11	20	16	12	180	25	15	10	VC**1103**	SI60M025060-03510H	TT08PH	0.29	●	○
S20R-SVUCR/L11	25	20	16	200	25	18	8	VC**1103**	SI60M025060-03510H	TT08PH	0.5	●	●
S25S-SVUCR/L16	33	25	20	250	32	23	8	VC**1604**	SI60M040100-05812H	TT15PH	0.98	●	●

● Stock ○ Available upon Order

# SWLCR/L

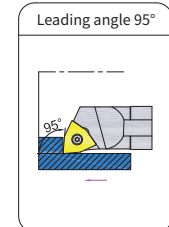
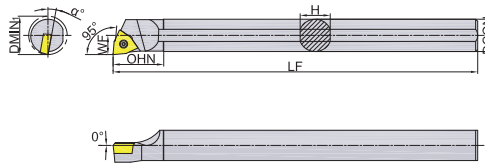



Ordering Code	Dimension (mm)							Insert	Screw	Wrench	Weight (KG)	Stock	
	DMIN1	DCON	WF	LF	OHN	H	$\alpha^\circ$					R	L
S12M-SWLCR/L06	16	12	8	150	18	11	12	WC**06T3**	SI60M040100-05812H	TT15PH	0.14	●	●
S16Q-SWLCR/L06	20	16	10	180	24	14.8	10	WC**06T3**	SI60M040100-05812H	TT15PH	0.29	●	●
S20R-SWLCR/L06	25	20	12	200	30	18.4	8	WC**06T3**	SI60M040100-05812H	TT15PH	0.5	●	●
S25S-SWLCR/L06	32	25	16	250	38	23.4	6	WC**06T3**	SI60M040100-05812H	TT15PH	0.98	●	●

● Stock ○ Available upon Order

Internal Turning Toolholder

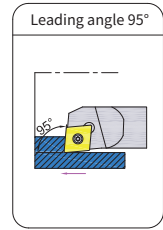
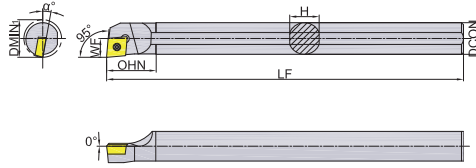
# SCLPR/L



Ordering Code	Dimension (mm)							Insert	Screw 	Wrench 	Weight (KG)	Stock	
	DMIN1	DCON	WF	LF	OHN	H	$\alpha^\circ$					R	L
S08K-SCLPR/L06	10	8	5.5	125	12	7	13	CP**0602**	SI60M025060-03510H	TT08PH	0.05	●	●
S10K-SCLPR/L06	12	10	6.5	125	15	9	12	CP**0602**	SI60M025060-03510H	TT08PH	0.08	●	●
S12M-SCLPR/L06	16	12	8	150	18	11	10	CP**0602**	SI60M025060-03510H	TT08PH	0.14	●	●
S12M-SCLPR/L09	16	12	8	150	18	11	12	CP**09T3**	SI60M040100-05812H	TT15PH	0.14	●	●
S16Q-SCLPR/L09	20	16	10	180	24	15	10	CP**09T3**	SI60M040100-05812H	TT15PH	0.29	●	●
S20R-SCLPR/L09	25	20	12	200	30	18	8	CP**09T3**	SI60M040100-05812H	TT15PH	0.5	●	○
S25S-SCLPR/L09	32	25	16	250	38	23	6	CP**09T3**	SI60M040100-05812H	TT15PH	0.98	●	●

● Stock ○ Available upon Order

## Internal Turning Toolholder

# STFPR/L

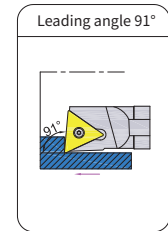
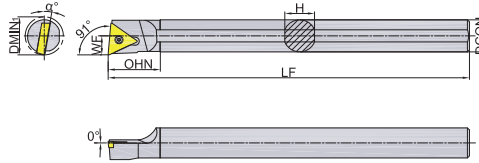

Ordering Code	Dimension (mm)							Insert	Screw	Wrench	Weight (KG)	Stock R
	DMIN1	DCON	WF	LF	OHN	H	$\alpha^\circ$					
S10K-STFPR1102	12	10	6.5	125	15	9	12	TP**1102**	SI60M025060-03510H	TT08PH	0.08	●
S12M-STFPR1102	16	12	8	150	18	11	10	TP**1102**	SI60M025060-03510H	TT08PH	0.14	●
S16Q-STFPR1102	20	16	10	180	24	15	8	TP**1102**	SI60M025060-03510H	TT08PH	0.29	●
S20R-STFPR1102	25	20	12	200	30	18	6	TP**1102**	SI60M025060-03510H	TT08PH	0.5	○
S20R-STFPR16T3	25	20	12	200	30	18	4	TP**16T3**	SI60M040100-05812H	TT15PH	0.5	●
S25S-STFPR16T3	32	25	16	250	38	23	6	TP**16T3**	SI60M040100-05812H	TT15PH	0.98	○

● Stock ○ Available upon Order

F

# PARTING AND GROOVING TOOLS



# Parting and Grooving Insert Identification System

## GZ. GK Series Insert Identification System

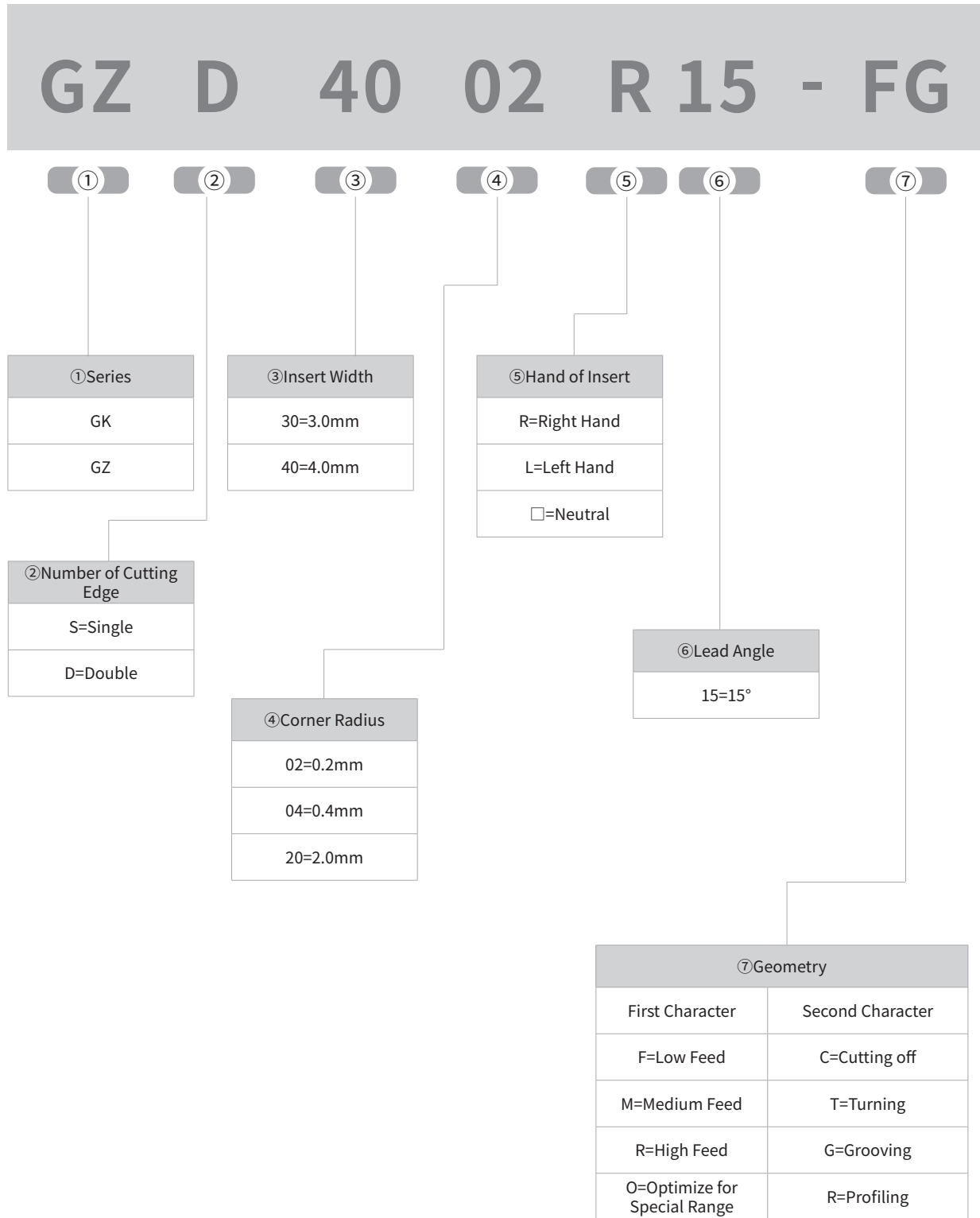

# Parting and Grooving Insert Identification System

## GB Series Insert Identification System

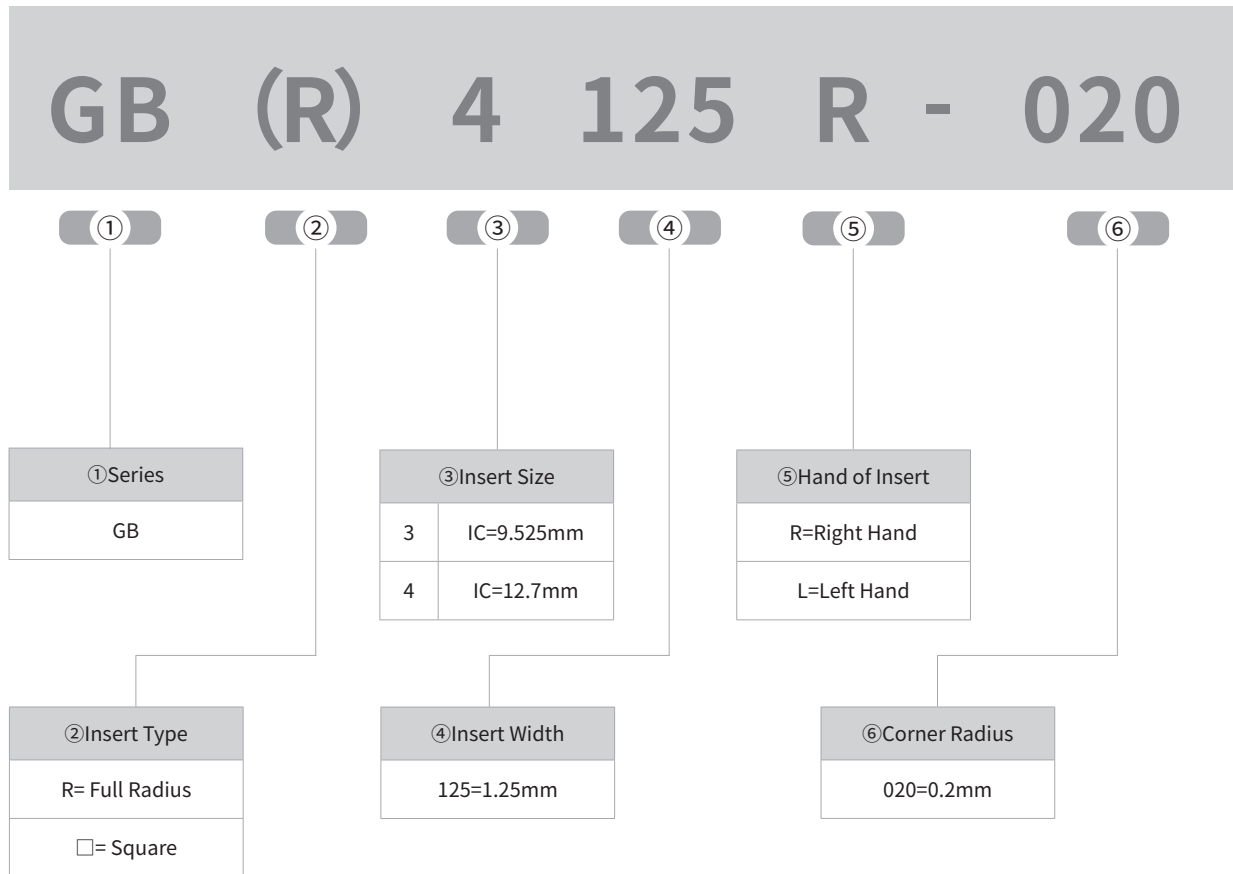



# Parting and Grooving Insert Identification System

## G-NOTCH Series Insert Identification System

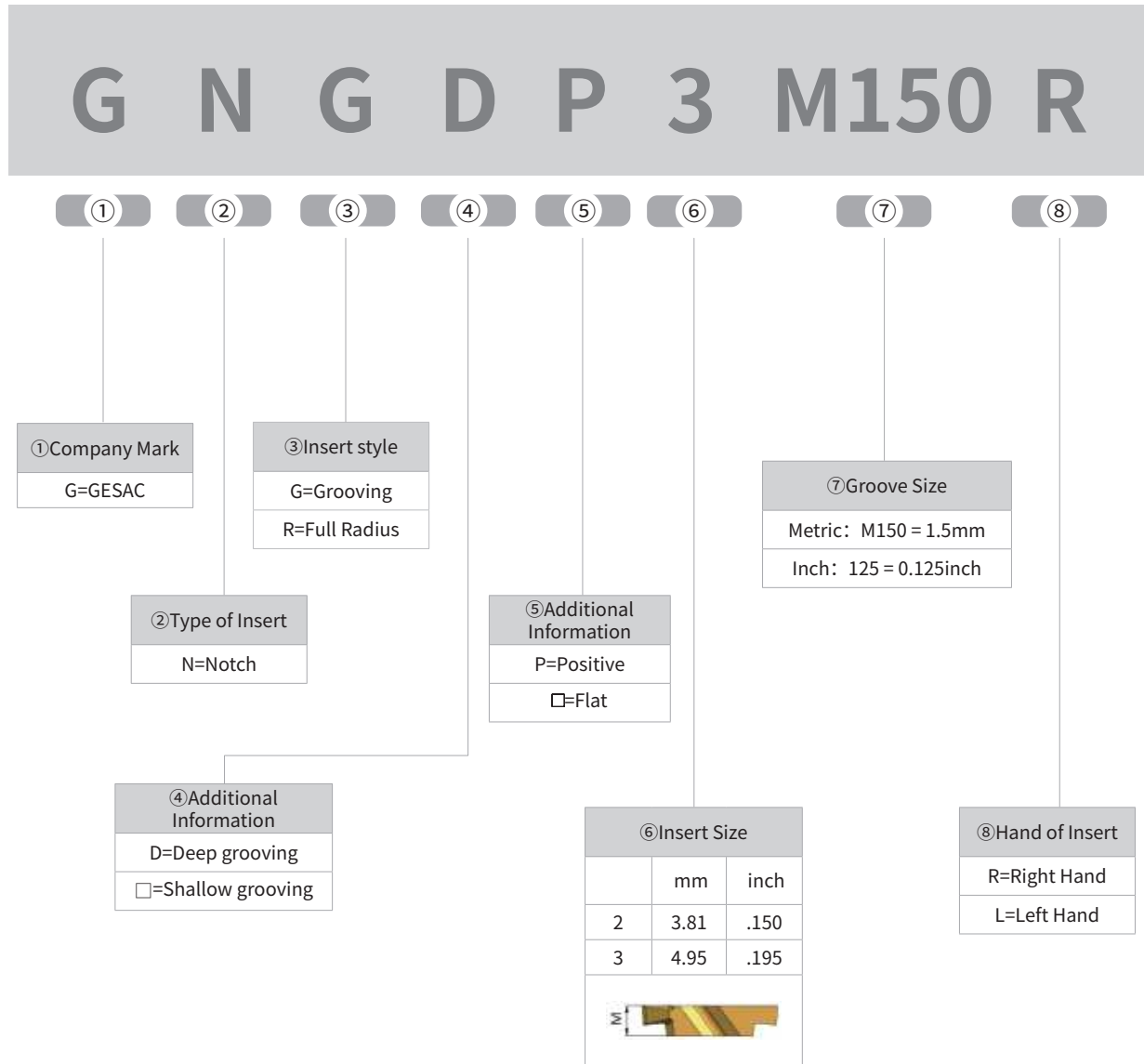

# Parting and Grooving Insert Identification System

## GST Series Grooving Inserts Identification System

# GSTC (A) 3 R 150 R 16 T

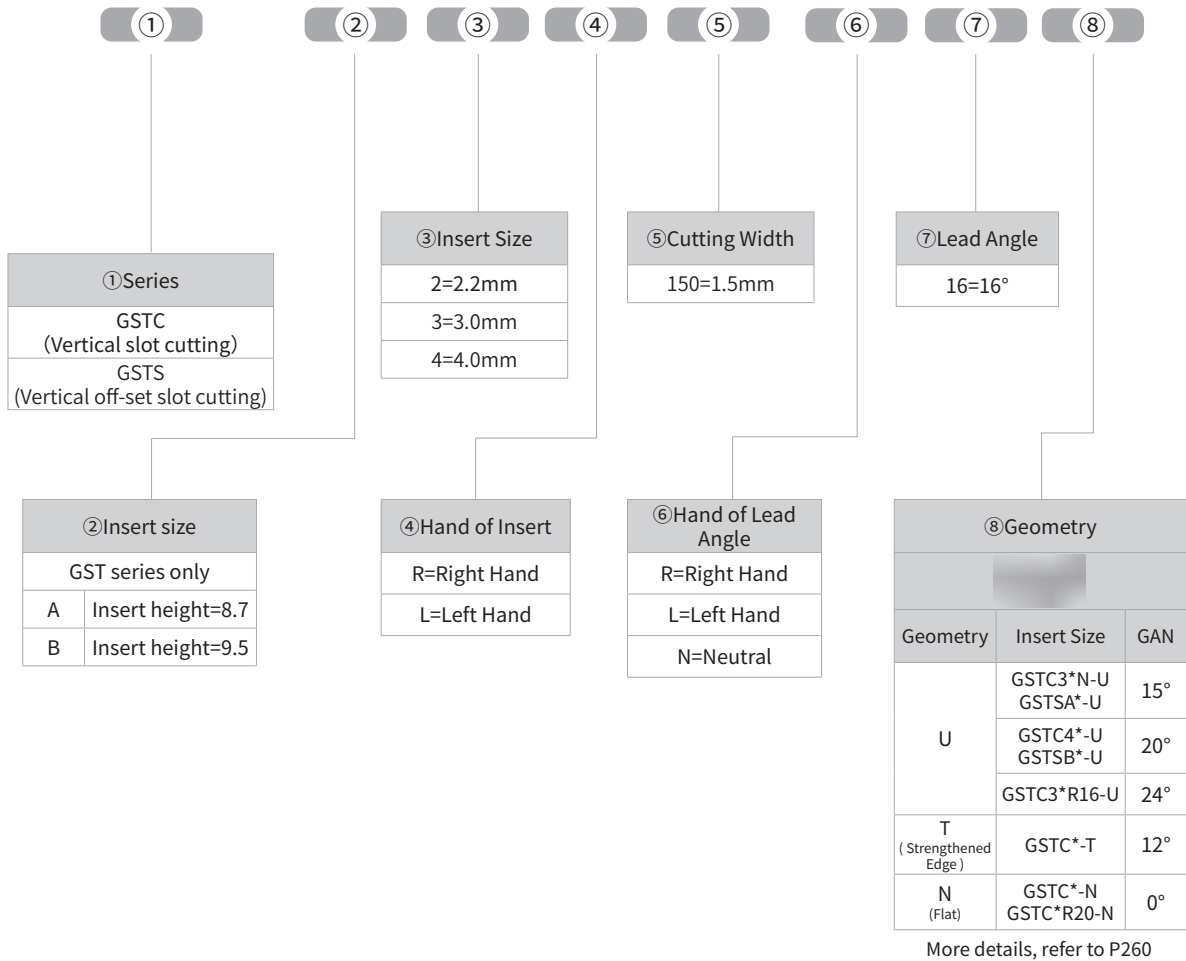

## Parting and Grooving Holders Identification System

GZ, GK Series Tool Holder Identification System

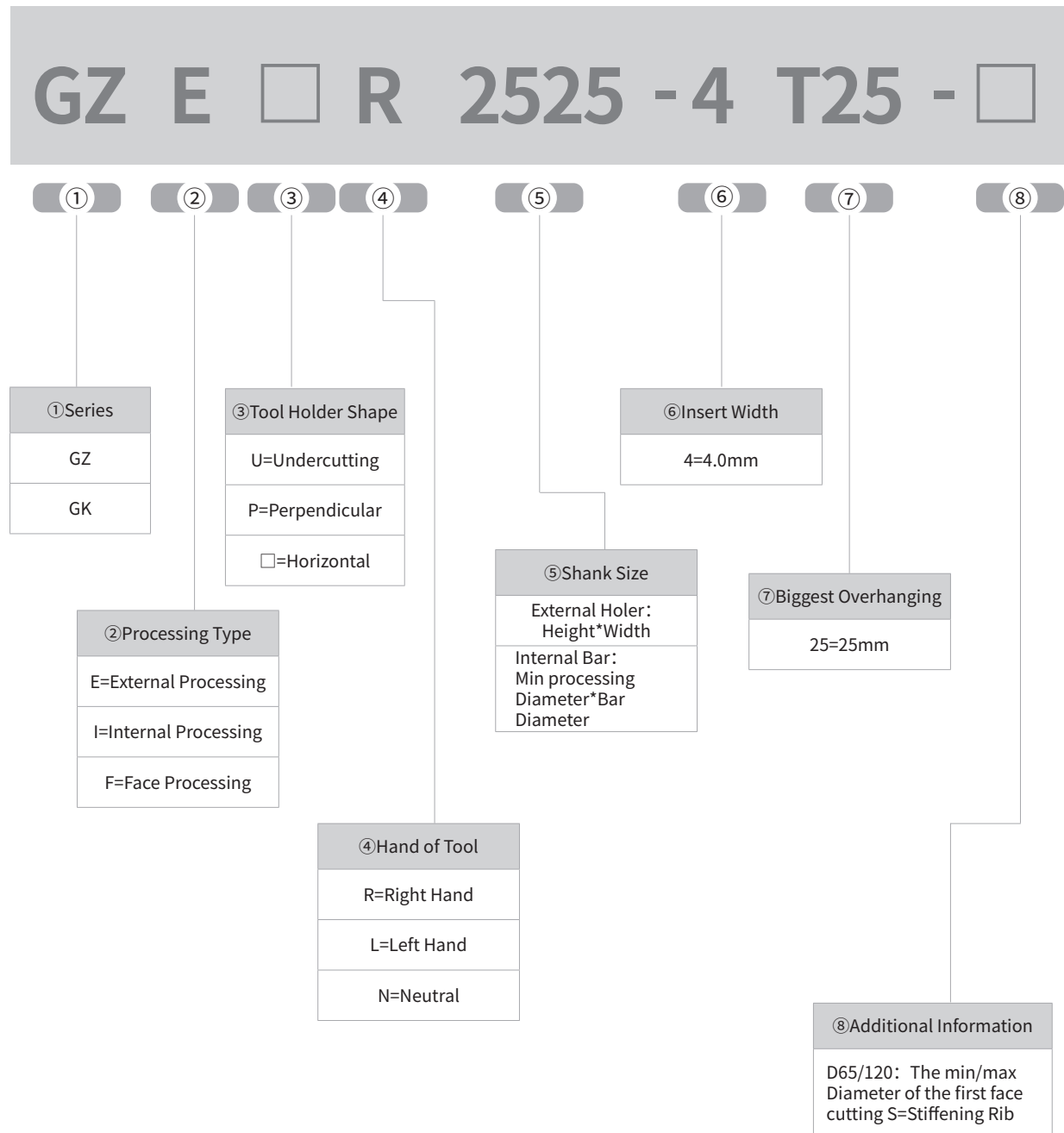

# Parting and Grooving Holders Identification System

## GB Series Tool Holder Identification System

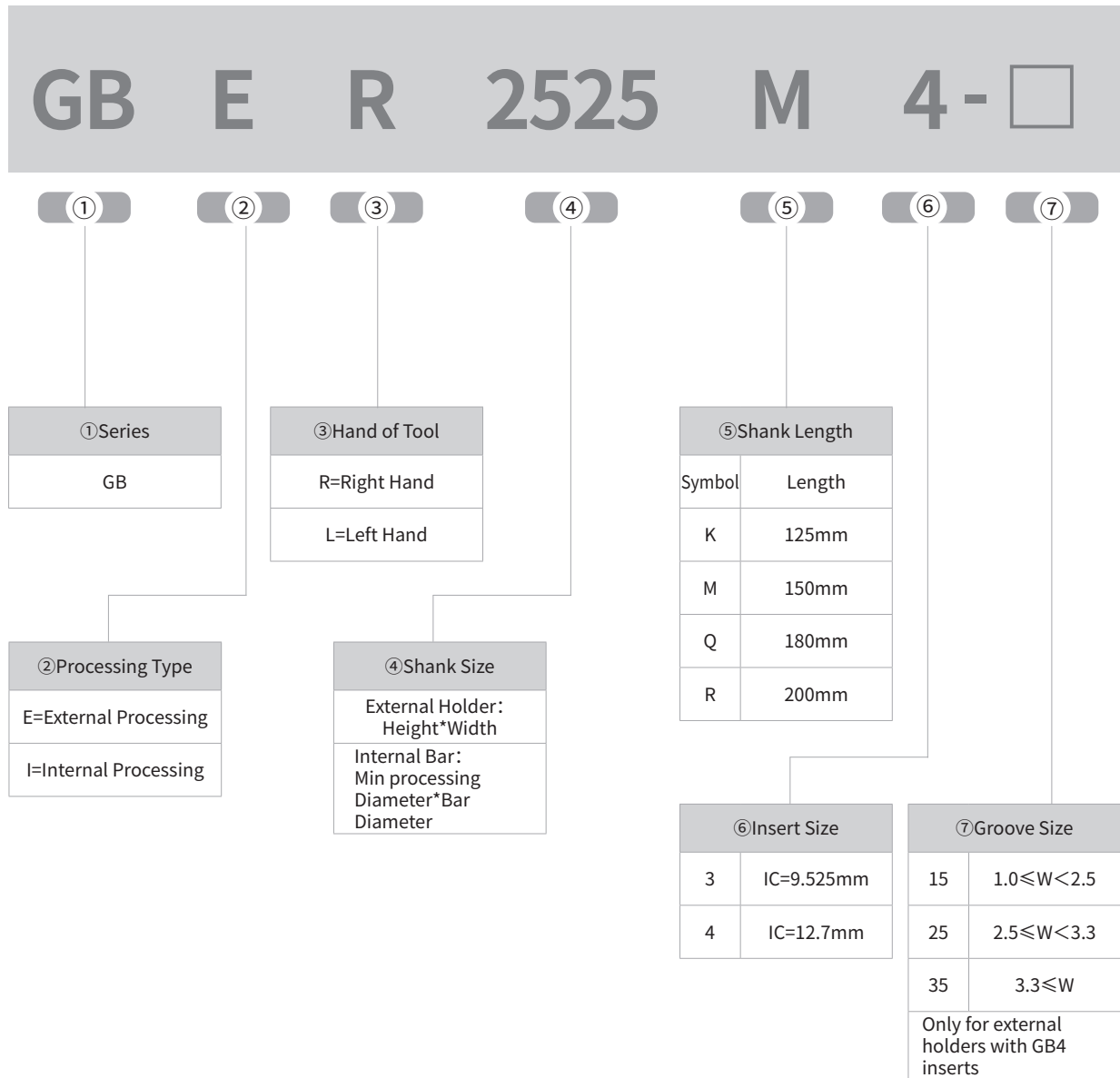

# Parting and Grooving Holders Identification System

## G-NOTCH External Holder Identification System

G N S R 2525 M 3

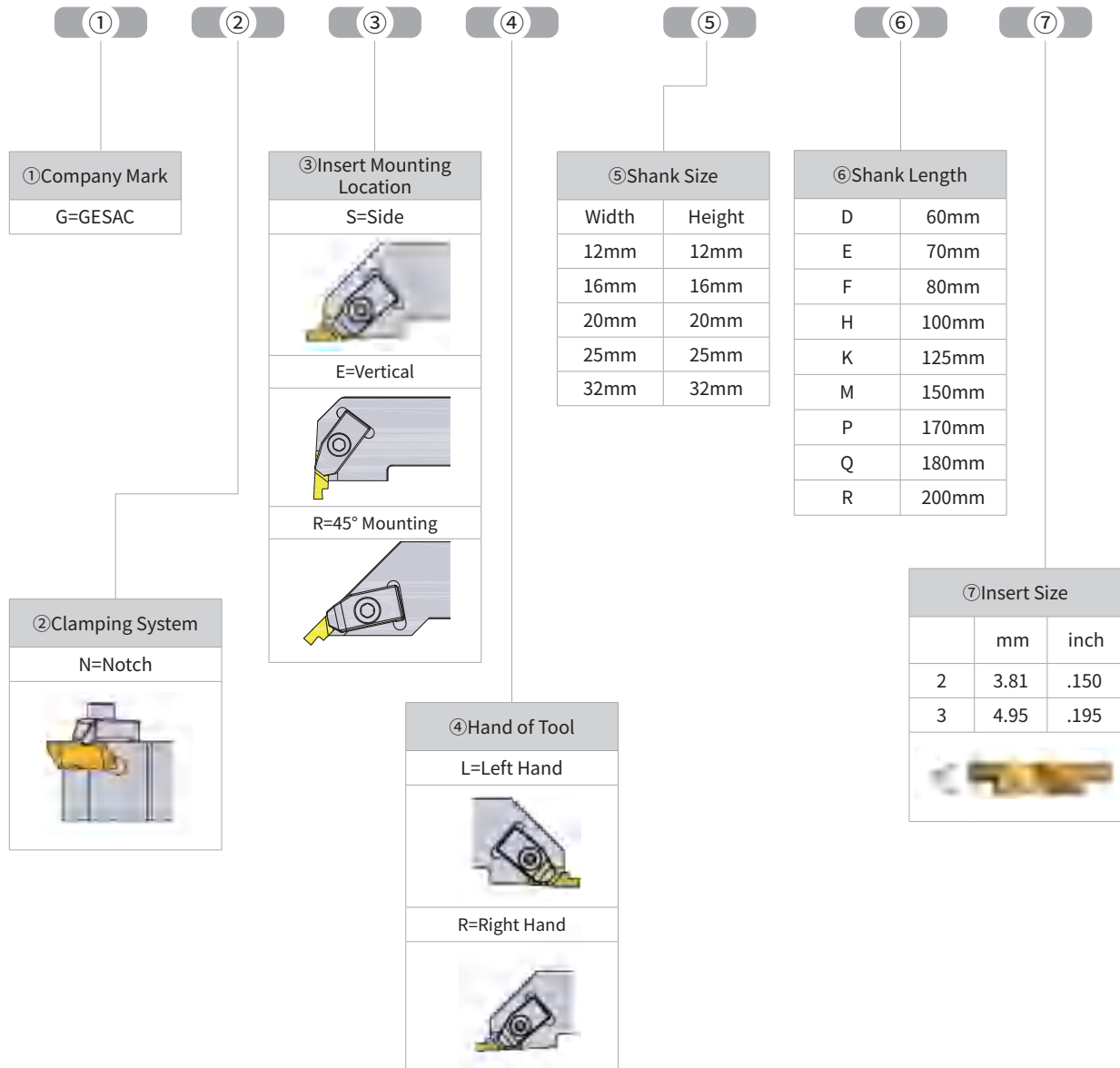

# Parting and Grooving Holders Identification System

## G-NOTCH Internal Holder Identification System

G
N
A
R
25
M
3

①

②

③

④

⑤

⑥

⑦

**① Company Mark**

G=GESAC

**③ Holder Type**

A=Steel With Coolant  
S=Steel without Coolant

**⑤ Shank Size**

Width	Height
12mm	12mm
16mm	16mm
20mm	20mm
25mm	25mm
32mm	32mm

**⑦ Insert Size**

	mm	inch
2	3.81	.150
3	4.95	.195



**② Clamping System**

N=Notch



**④ Hand of Tool**

L=Left Hand



R=Right Hand



**⑥ Shank Length**

D	60mm
E	70mm
F	80mm
H	100mm
K	125mm
M	150mm
P	170mm
Q	180mm
R	200mm

Note: Left hand holders go with right hand inserts, right hand holders go with left hand inserts.



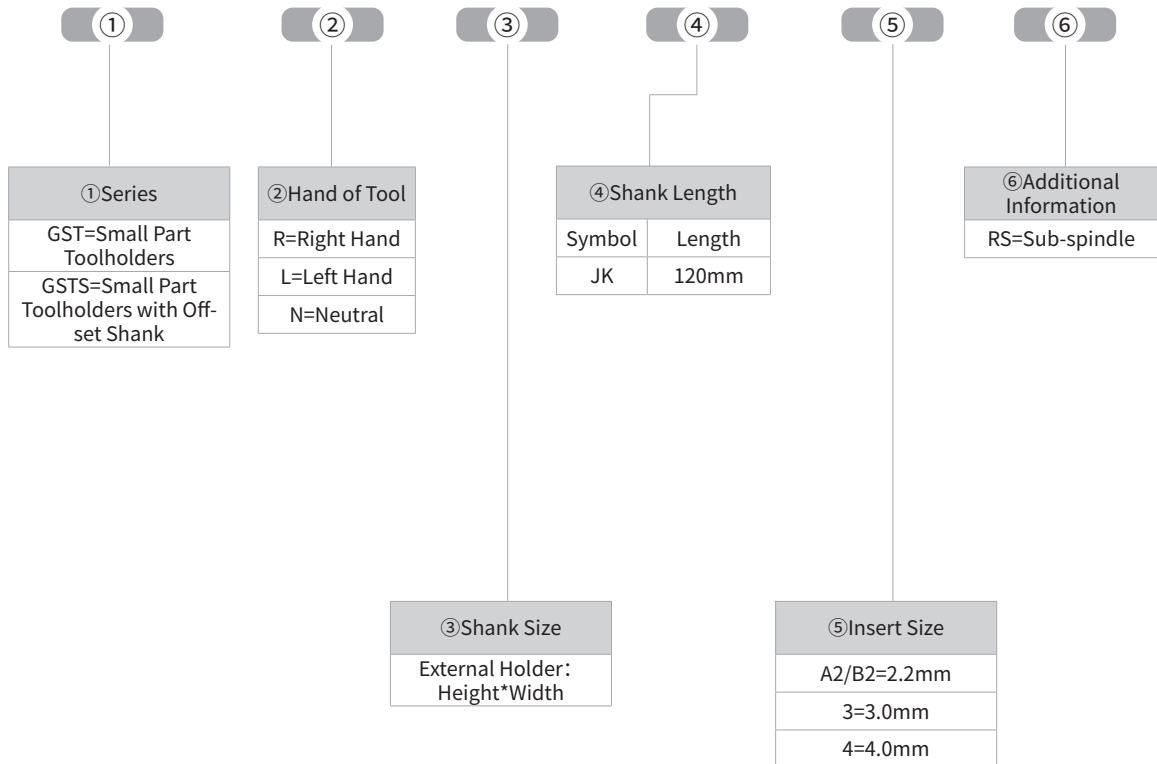

# Parting and Grooving Holders Identification System

GST Series Tool Holder Identification System

# GST(S) R 1212 JK (A)4-RS





## Overview of Parting and Grooving Inserts

Shape	Geometry	Application	Width	Page
	MT	Medium Turning	2.0-8.0 (mm)	P176
	MR	Medium Profiling	2.0-8.0 (mm)	P176
	FG	Precision Grooving	3.0-6.0 (mm)	P177
	OR	Precision Profiling	3.0-6.0 (mm)	P177
	GB	Precision Grooving	0.5-4.3 (mm)	P178 - P180



## Overview of Parting and Grooving Inserts

Shape	Geometry	Application	Width	Page
	GNGP	Precision Grooving	1.00-3.50 (mm)	P181 - P182
	GNGDP	Precision Deep Grooving	1.00-3.50 (mm)	P183
	GNR	Precision Profiling	2.00-3.18 (mm)	P183
	GST	Small Parts Parting and Grooving	0.5-2.0 (mm)	P184 - P187

Parting and Grooving Inserts

# MT

## Medium Turning Inserts

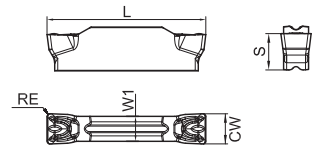

Ordering Code	Dimension (mm)					Coated Carbides			
	CW±0.05	RE±0.05	L	W1	S	GP1225	GK1115	GA4230	GA4330
GKD2002-MT	2.0	0.2	16.1	1.6	3.5	●	●	●	●
GKD2502-MT	2.5	0.2	18.6	2.0	3.85	●	●	●	●
GKD3004-MT	3.0	0.4	21.2	2.35	4.8	●	●	●	●
GKD4004-MT	4.0	0.4	21.0	3.3	4.8	●	●	●	●
GKD5004-MT	5.0	0.4	26.0	4.1	5.8	●	●	●	●
GKD5008-MT	5.0	0.8	26.0	4.1	5.8	●	●	●	●
GKD6004-MT	6.0	0.4	26.0	5.0	5.8	●	●	●	●
GKD6008-MT	6.0	0.8	26.0	5.0	5.8	○	●	●	●
GKD8008-MT	8.0	0.8	31.0	6.0	6.5	○	○	○	●

©For tools, refer to page 188 to page 192.

●Stock ○Available upon order

# MR

## Medium Profiling Inserts

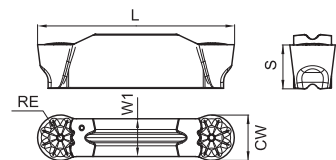

Ordering Code	Dimension (mm)					Coated Carbides			
	CW±0.05	RE±0.05	L	W1	S	GP1105	GP1225	GK1115	GA4230
GKD2010-MR	2.0	1.0	16.0	1.6	3.5	○	●	●	●
GKD3015-MR	3.0	1.5	21.2	2.35	4.8	○	○	●	●
GKD4020-MR	4.0	2.0	21.0	3.3	4.8	●	○	●	●
GKD5025-MR	5.0	2.5	26.0	4.1	5.8	○	○	●	●
GKD6030-MR	6.0	3.0	25.9	5.0	5.8	○	○	●	●
GKD8040-MR	8.0	4.0	31.0	6.0	6.5	○	○	○	○

©For tools, refer to page 188 to page 192.

●Stock ○Available upon order

## Parting and Grooving Inserts

**FG**

## Precision Grooving Inserts

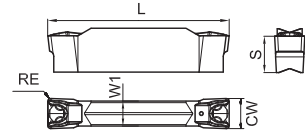

Ordering Code	Dimension (mm)					Coated Carbides	Carbide
	CW±0.02	RE±0.05	L	W1	S	GS3125	GS9125
GZD3002-FG	3.0	0.2	20.4	2.3	4.6	●	○
GZD3004-FG	3.0	0.4	20.4	2.3	4.6	●	○
GZD4002-FG	4.0	0.2	24.0	3.3	4.8	●	●
GZD4004-FG	4.0	0.4	24.0	3.3	4.8	●	●
GZD5002-FG	5.0	0.2	24.0	3.3	4.8	●	○
GZD5004-FG	5.0	0.4	24.0	3.3	4.8	○	●
GZD6002-FG	6.0	0.2	24.0	4.2	4.8	○	●
GZD6004-FG	6.0	0.4	24.0	4.2	4.8	●	●

©For tools, refer to page 193.

●Stock ○Available upon order

**OR**

## Precision Profiling Inserts

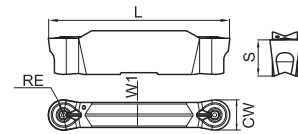

Ordering Code	Dimension (mm)					Coated Carbides
	CW±0.02	RE±0.05	L	W1	S	GS3115
GZD3015-OR	3.0	1.5	21.1	2.3	4.6	●
GZD4020-OR	4.0	2.0	24.0	3.3	4.8	●
GZD5025-OR	5.0	2.5	24.0	3.3	4.8	○
GZD6030-OR	6.0	3.0	24.0	4.2	4.8	●

©For tools, refer to page 193.

●Stock ○Available upon order

## Parting and Grooving Inserts

**GB**

Precision Grooving Inserts

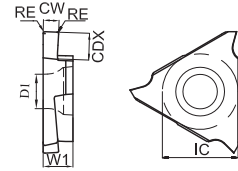

Ordering Code	Dimension (mm)						Coated Carbides
	CW±0.025	CDX	RE	IC	W1	D1	GA4230
GB3050R-005	0.50	1.0	0.05	9.525	3.18	4.4	●
GB3050L-005	0.50	1.0	0.05	9.525	3.18	4.4	●
GB3075R-010	0.75	2.0	0.1	9.525	3.18	4.4	●
GB3075L-010	0.75	2.0	0.1	9.525	3.18	4.4	●
GB3080R-005	0.80	2.0	0.05	9.525	3.18	4.4	○
GB3080L-005	0.80	2.0	0.05	9.525	3.18	4.4	●
GB3095R-010	0.95	2.0	0.1	9.525	3.18	4.4	○
GB3100R-005	1.00	2.0	0.05	9.525	3.18	4.4	●
GB3100R-010	1.00	2.0	0.1	9.525	3.18	4.4	●
GB3120R-010	1.20	2.0	0.1	9.525	3.18	4.4	○
GB3120L-010	1.20	2.0	0.1	9.525	3.18	4.4	●
GB3120R-020	1.20	2.0	0.2	9.525	3.18	4.4	○
GB3125L-010	1.25	2.0	0.1	9.525	3.18	4.4	●
GB3125R-010	1.25	2.0	0.1	9.525	3.18	4.4	●
GB3140L-010	1.40	2.0	0.1	9.525	3.18	4.4	●
GB3140R-010	1.40	2.0	0.1	9.525	3.18	4.4	○
GB3140R-020	1.40	2.0	0.2	9.525	3.18	4.4	●
GB3140L-020	1.40	2.0	0.2	9.525	3.18	4.4	●
GB3150L-010	1.50	2.0	0.1	9.525	3.18	4.4	●
GB3150R-010	1.50	2.0	0.1	9.525	3.18	4.4	○
GB3150R-020	1.50	2.0	0.2	9.525	3.18	4.4	●
GB3150L-020	1.50	2.0	0.2	9.525	3.18	4.4	●
GB3200L-010	2.00	2.5	0.1	9.525	3.18	4.4	●
GB3200R-010	2.00	2.5	0.1	9.525	3.18	4.4	○
GB3200R-020	2.00	2.5	0.2	9.525	3.18	4.4	○
GB3200L-020	2.00	2.5	0.2	9.525	3.18	4.4	●
GB3250R-010	2.50	2.5	0.1	9.525	3.18	4.4	●
GB3250R-020	2.50	2.5	0.2	9.525	3.18	4.4	●
GB3250L-010	2.50	2.5	0.1	9.525	3.18	4.4	●
GB3250L-020	2.50	2.5	0.2	9.525	3.18	4.4	●
GB3300R-020	3.00	2.5	0.2	9.525	3.18	4.4	○
GB3300L-020	3.00	2.5	0.2	9.525	3.18	4.4	○

©For tools, refer to page 194 to page 195.

●Stock ○Available upon order

## Parting and Grooving Inserts

**GB**

Precision Grooving Inserts

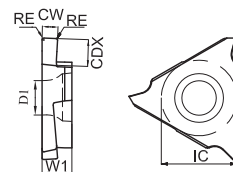

Ordering Code	Dimension (mm)						Coated Carbides
	CW±0.025	CDX	RE	IC	W1	D1	GA4230
GB4125R -020	1.25	2.0	0.2	12.7	4.76	5.5	○
GB4125L-020	1.25	2.0	0.2	12.7	4.76	5.5	●
GB4150R-010	1.50	3.5	0.1	12.7	4.76	5.5	●
GB4150R -020	1.50	3.5	0.2	12.7	4.76	5.5	●
GB4150L -020	1.50	3.5	0.2	12.7	4.76	5.5	○
GB4175R -020	1.75	3.5	0.2	12.7	4.76	5.5	○
GB4185R -020	1.85	3.5	0.2	12.7	4.76	5.5	○
GB4200R -020	2.00	3.5	0.2	12.7	4.76	5.5	●
GB4200L -020	2.00	3.5	0.2	12.7	4.76	5.5	●
GB4200R -030	2.00	3.5	0.3	12.7	4.76	5.5	●
GB4210R -050	2.10	4.0	0.5	12.7	4.76	5.5	○
GB4220R -030	2.20	4.0	0.3	12.7	4.76	5.5	●
GB4250R -030	2.50	4.0	0.3	12.7	4.76	5.5	●
GB4250L -030	2.50	4.0	0.3	12.7	4.76	5.5	○
GB4265R -030	2.65	4.0	0.3	12.7	4.76	5.5	●
GB4280R -030	2.80	5.0	0.3	12.7	4.76	5.5	●
GB4300R -030	3.00	4.0	0.3	12.7	4.76	5.5	●
GB4300L -030	3.00	4.0	0.3	12.7	4.76	5.5	●
GB4350R -030	3.50	5.0	0.3	12.7	4.76	5.5	○
GB4400R -040	4.00	5.0	0.4	12.7	4.76	5.5	○
GB4400L -040	4.00	5.0	0.4	12.7	4.76	5.5	○
GB4430R -040	4.30	5.0	0.4	12.7	4.76	5.5	○

©For tools, refer to page 194 to page 195.

●Stock ○Available upon order

## Parting and Grooving Inserts

**GBR**

Precision Profiling Inserts

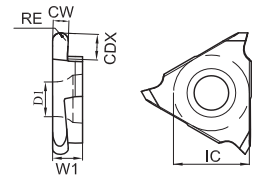

Ordering Code	Dimension (mm)						Coated Carbides
	CW±0.025	CDX	RE	IC	W1	D1	GA4230
GBR4100R -050	1.00	2.0	0.5	12.7	4.76	5.5	○
GBR4100L -050	1.00	2.0	0.5	12.7	4.76	5.5	○
GBR4150R -075	1.50	3.5	0.75	12.7	4.76	5.5	●
GBR4150L -075	1.50	3.5	0.75	12.7	4.76	5.5	○
GBR4200R -100	2.00	3.5	1.0	12.7	4.76	5.5	○
GBR4200L -100	2.00	3.5	1.0	12.7	4.76	5.5	○
GBR4250R -125	2.50	4.0	1.25	12.7	4.76	5.5	○
GBR4250L -125	2.50	4.0	1.25	12.7	4.76	5.5	○
GBR4300R -150	3.00	4.0	1.5	12.7	4.76	5.5	○
GBR4300L -150	3.00	4.0	1.5	12.7	4.76	5.5	○
GBR4400R -200	4.00	5.0	2.0	12.7	4.76	5.5	○
GBR4400L -200	4.00	5.0	2.0	12.7	4.76	5.5	○

©For tools, refer to page 194 to page 195.

●Stock ○Available upon order

## Parting and Grooving Inserts

**GNGP**

Precision Grooving Inserts (positive rake angle)

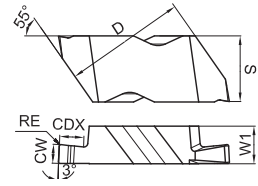

Ordering Code	Dimension (mm)						Insert Size	Coated Carbides
	CW±0.025	RE	CDX	S	W1	D		GM3225
GNGP2M100L	1.00	0.09	1.27	5.56	3.81	8.74	2	○
GNGP2M100R	1.00	0.09	1.27	5.56	3.81	8.74	2	○
GNGP2047L	1.19	0.09	1.27	5.56	3.81	8.74	2	○
GNGP2047R	1.19	0.09	1.27	5.56	3.81	8.74	2	○
GNGP2M150L	1.50	0.19	2.79	5.56	3.81	8.74	2	○
GNGP2M150R	1.50	0.19	2.79	5.56	3.81	8.74	2	○
GNGP2062L	1.57	0.19	2.79	5.56	3.81	8.74	2	○
GNGP2062R	1.57	0.19	2.79	5.56	3.81	8.74	2	●
GNGP2M170L	1.70	0.19	2.79	5.56	3.81	8.74	2	○
GNGP2M170R	1.70	0.19	2.79	5.56	3.81	8.74	2	○
GNGP2070L	1.78	0.19	2.79	5.56	3.81	8.74	2	○
GNGP2078L	1.98	0.19	2.79	5.56	3.81	8.74	2	○
GNGP2078R	1.98	0.19	2.79	5.56	3.81	8.74	2	●
GNGP2M200L	2.00	0.19	2.79	5.56	3.81	8.74	2	●
GNGP2M200R	2.00	0.19	2.79	5.56	3.81	8.74	2	○
GNGP2M220L	2.20	0.19	2.79	5.56	3.81	8.74	2	○
GNGP2M220R	2.20	0.19	2.79	5.56	3.81	8.74	2	○
GNGP2094L	2.38	0.19	2.79	5.56	3.81	8.74	2	○
GNGP2094R	2.38	0.19	2.79	5.56	3.81	8.74	2	●
GNGP2M250L	2.50	0.19	2.79	5.56	3.81	8.74	2	○
GNGP2M250R	2.50	0.19	2.79	5.56	3.81	8.74	2	○
GNGP2125L	3.18	0.19	2.79	5.56	3.81	8.74	2	○
GNGP2125R	3.18	0.19	2.79	5.56	3.81	8.74	2	●
GNGP3031L	0.79	0.09	1.27	8.74	4.95	16.1	3	○
GNGP3031R	0.79	0.09	1.27	8.74	4.95	16.1	3	○
GNGP3M100L	1.00	0.19	1.91	8.74	4.95	16.1	3	○
GNGP3M100R	1.00	0.19	1.91	8.74	4.95	16.1	3	○
GNGP3047L	1.19	0.19	1.91	8.74	4.95	16.1	3	○
GNGP3047R	1.19	0.19	1.91	8.74	4.95	16.1	3	○



●Stock ○Available upon order

## Parting and Grooving Inserts

**GNGP**

Precision Grooving Inserts (positive rake angle)

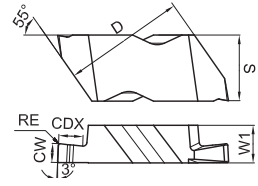

Ordering Code	Dimension (mm)						Insert Size	Coated Carbides
	CW±0.025	RE	CDX	S	W1	D		GM3225
GNGP3M150L	1.50	0.19	2.39	8.74	4.95	16.1	3	○
GNGP3M150R	1.50	0.19	2.39	8.74	4.95	16.1	3	○
GNGP3062L	1.58	0.19	2.39	8.74	4.95	16.1	3	●
GNGP3062R	1.58	0.19	2.39	8.74	4.95	16.1	3	●
GNGP3070L	1.78	0.19	2.39	8.74	4.95	16.1	3	○
GNGP3078L	1.98	0.19	2.39	8.74	4.95	16.1	3	○
GNGP3078R	1.98	0.19	2.39	8.74	4.95	16.1	3	●
GNGP3M200L	2.00	0.19	2.39	8.74	4.95	16.1	3	○
GNGP3M200R	2.00	0.19	2.39	8.74	4.95	16.1	3	○
GNGP3094L	2.39	0.19	3.81	8.74	4.95	16.1	3	○
GNGP3094R	2.39	0.19	3.81	8.74	4.95	16.1	3	●
GNGP3M250L	2.50	0.19	3.81	8.74	4.95	16.1	3	○
GNGP3M250R	2.50	0.19	3.81	8.74	4.95	16.1	3	○
GNGP3M300L	3.00	0.19	3.81	8.74	4.95	16.1	3	○
GNGP3M300R	3.00	0.19	3.81	8.74	4.95	16.1	3	●
GNGP3125L	3.18	0.19	3.81	8.74	4.95	16.1	3	○
GNGP3125R	3.18	0.19	3.81	8.74	4.95	16.1	3	●
GNGP3M350L	3.50	0.19	3.81	8.74	4.95	16.1	3	○
GNGP3M350R	3.50	0.19	3.81	8.74	4.95	16.1	3	○



●Stock ○Available upon order



## Parting and Grooving Inserts

# GNGDP

Precision Deep Grooving Inserts (positive rake angle)

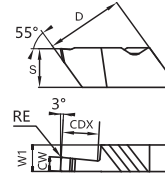

Ordering Code	Dimension (mm)					Insert Size	Coated Carbides	
	CW±0.025	RE	CDX	S	W1		GST7115	GST7130
GNGDP2M150L	1.5	0.19	4.07	5.56	3.81	2	●	
GNGDP2M150R	1.5	0.19	4.07	5.56	3.81	2	●	
GNGDP2M200L	2.0	0.19	5.07	5.56	3.81	2	●	
GNGDP2M200R	2.0	0.19	5.07	5.56	3.81	2	●	
GNGDP2M250L	2.5	0.19	5.07	5.56	3.81	2	●	
GNGDP3062R	1.58	0.19	3.18	8.72	4.95	3	○	
GNGDP3M200L	2.0	0.19	4.09	8.715	4.95	3	●	
GNGDP3M200R	2.0	0.19	4.09	8.715	4.95	3		●
GNGDP3094R	2.39	0.19	6.35	8.714	4.95	3	○	
GNGDP3M300R	3.0	0.19	6.35	8.715	4.95	3		●
GNGDP3125R	3.18	0.19	6.35	8.715	4.95	3	○	



●Stock ○Available upon order

# GNR

Precision Profile Inserts

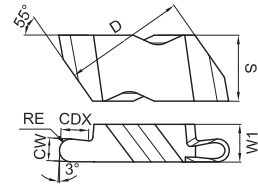

Ordering Code	Dimension (mm)						Insert Size	Coated Carbides	
	CW±0.025	RE	CDX	S	W1	D		GM3225	
GNR3M100R	2.00	1.00	2.39	8.74	4.95	16.1	3	○	
GNR3M100L	2.00	1.00	2.39	8.74	4.95	16.10	3	●	
GNR3M150R	3.00	1.50	3.81	8.74	4.95	16.1	3	○	
GNR3047L	2.39	1.19	3.81	8.74	4.95	16.1	3	○	
GNR3047R	2.39	1.19	3.81	8.74	4.95	16.1	3	○	
GNR3062R	3.18	1.59	3.81	8.74	4.95	16.1	3	○	



●Stock ○Available upon order

## Parting and Grooving Inserts

**GSTC**

## Parting Inserts

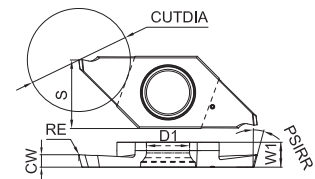

Ordering Code	Dimension (mm)							Coated Carbides	
	CW	CUTDIA	RE	W1	S	D1	PSIRR	GAT7115	GAT7125
GSTC3L100N-N	1	12	0	3	8.7	5	0°	○	○
GSTC3R100N-N	1	12	0	3	8.7	5	0°	○	○
GSTC3L150N-N	1.5	12	0	3	8.7	5	0°	○	○
GSTC3R150N-N	1.5	12	0	3	8.7	5	0°	○	○
GSTC3L200N-N	2	12	0	3	8.7	5	0°	○	○
GSTC3R200N-N	2	12	0	3	8.7	5	0°	○	○
GSTC3L100R20-N	1	12	0	3	8.7	5	20°	○	○
GSTC3R100R20-N	1	12	0	3	8.7	5	20°	○	○
GSTC3L150R20-N	1.5	12	0	3	8.7	5	20°	○	○
GSTC3R150R20-N	1.5	12	0	3	8.7	5	20°	○	○
GSTC3L200R20-N	2	12	0	3	8.7	5	20°	○	○
GSTC3R200R20-N	2	12	0	3	8.7	5	20°	○	○
GSTC4L150N-N	1.5	16	0	4	9.5	5	0°	○	○
GSTC4R150N-N	1.5	16	0	4	9.5	5	0°	○	○
GSTC4L200N-N	2	16	0	4	9.5	5	0°	○	○
GSTC4R200N-N	2	16	0	4	9.5	5	0°	○	○
GSTC4L150R20-N	1.5	16	0	4	9.5	5	20°	○	○
GSTC4R150R20-N	1.5	16	0	4	9.5	5	20°	○	○
GSTC4L200R20-N	2	16	0	4	9.5	5	20°	○	○
GSTC4R200R20-N	2	16	0	4	9.5	5	20°	○	○

●Stock ○Available upon order

## Parting and Grooving Inserts

# GSTC

Parting Inserts

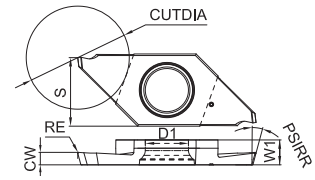

Ordering Code	Dimension (mm)							Coated Carbides	
	CW	CUTDIA	RE	W1	S	D1	PSIRR	GAT7115	GAT7125
GSTC3L100N-T	1	12	0.08	3	8.7	5	0°	○	●
GSTC3R100N-T	1	12	0.08	3	8.7	5	0°	●	●
GSTC3L150N-T	1.5	12	0.08	3	8.7	5	0°	○	●
GSTC3R150N-T	1.5	12	0.08	3	8.7	5	0°	●	○
GSTC3L200N-T	2	12	0.08	3	8.7	5	0°	○	○
GSTC3R200N-T	2	12	0.08	3	8.7	5	0°	●	○
GSTC3L100R16-T	1	12	0.08	3	8.7	5	16°	○	●
GSTC3R100R16-T	1	12	0.08	3	8.7	5	16°	●	●
GSTC3L150R16-T	1.5	12	0.08	3	8.7	5	16°	○	○
GSTC3R150R16-T	1.5	12	0.08	3	8.7	5	16°	●	●
GSTC3L200R16-T	2	12	0.08	3	8.7	5	16°	○	○
GSTC3R200R16-T	2	12	0.08	3	8.7	5	16°	●	○
GSTC4L150N-T	1.5	16	0.08	4	9.5	5	0°	○	○
GSTC4R150N-T	1.5	16	0.08	4	9.5	5	0°	●	○
GSTC4L200N-T	2	16	0.08	4	9.5	5	0°	○	○
GSTC4R200N-T	2	16	0.08	4	9.5	5	0°	○	○
GSTC4L150R16-T	1.5	16	0.08	4	9.5	5	16°	○	○
GSTC4R150R16-T	1.5	16	0.08	4	9.5	5	16°	○	○
GSTC4L200R16-T	2	16	0.08	4	9.5	5	16°	○	○
GSTC4R200R16-T	2	16	0.08	4	9.5	5	16°	○	●

●Stock ○Available upon order

## Parting and Grooving Inserts

**GSTC**

## Parting Inserts

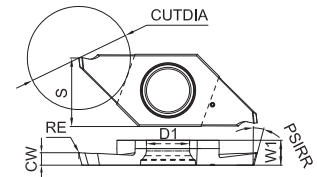

Ordering Code	Dimension (mm)							Coated Carbides	
	CW	CUTDIA	RE	W1	S	D1	PSIRR	GAT7115	GAT7125
GSTC3L100N-U	1	12	0.03	3	8.7	5	0°	○	○
GSTC3R100N-U	1	12	0.03	3	8.7	5	0°	●	○
GSTC3L125N-U	1.25	12	0.03	3	8.7	5	0°	○	●
GSTC3R125N-U	1.25	12	0.03	3	8.7	5	0°	○	●
GSTC3L150N-U	1.5	12	0.03	3	8.7	5	0°	●	○
GSTC3R150N-U	1.5	12	0.03	3	8.7	5	0°	●	●
GSTC3L200N-U	2	12	0.03	3	8.7	5	0°	○	○
GSTC3R200N-U	2	12	0.03	3	8.7	5	0°	●	●
GSTC3L100R16-U	1	12	0.03	3	8.7	5	16°	●	●
GSTC3R100R16-U	1	12	0.03	3	8.7	5	16°	●	●
GSTC3L125R16-U	1.25	12	0.03	3	8.7	5	16°	○	○
GSTC3R125R16-U	1.25	12	0.03	3	8.7	5	16°	○	●
GSTC3L150R16-U	1.5	12	0.03	3	8.7	5	16°	○	○
GSTC3R150R16-U	1.5	12	0.03	3	8.7	5	16°	●	○
GSTC3R200R16-U	2	12	0.03	3	8.7	5	16°	○	○
GSTC3R200R16-U	2	12	0.03	3	8.7	5	16°	●	●
GSTC4L150N-U	1.5	16	0.05	4	9.5	5	0°	●	○
GSTC4R150N-U	1.5	16	0.05	4	9.5	5	0°	●	●
GSTC4L200N-U	2	16	0.05	4	9.5	5	0°	○	○
GSTC4R200N-U	2	16	0.05	4	9.5	5	0°	○	●
GSTC4L150R16-U	1.5	16	0.05	4	9.5	5	16°	○	○
GSTC4R150R16-U	1.5	16	0.05	4	9.5	5	16°	●	○
GSTC4L200R16-U	2	16	0.05	4	9.5	5	16°	●	○
GSTC4R200R16-U	2	16	0.05	4	9.5	5	16°	●	○

●Stock ○Available upon order

## Parting and Grooving Inserts

# GSTS

Parting Inserts

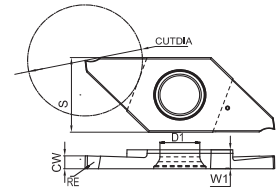

Ordering Code	Dimension (mm)							Coated Carbides	
	CW	CUTDIA	RE	W1	S	D1	PSIRR	GAT7115	GAT7125
GSTSA2L100N-U	1	6	0.05	2.2	8.7	4.4	0°	●	●
GSTSA2R100N-U	1	6	0.05	2.2	8.7	4.4	0°	○	○
GSTSA2L150N-U	1.5	9	0.05	2.2	8.7	4.4	0°	●	○
GSTSA2R150N-U	1.5	9	0.05	2.2	8.7	4.4	0°	○	●
GSTSA2L200N-U	2	12	0.05	2.2	8.7	4.4	0°	○	○
GSTSA2R200N-U	2	12	0.05	2.2	8.7	4.4	0°	○	○
GSTSB2L150N-U	1.5	14	0.05	2.2	9.5	4.4	0°	○	○
GSTSB2R150N-U	1.5	14	0.05	2.2	9.5	4.4	0°	○	○
GSTSB2L200N-U	2	16	0.05	2.2	9.5	4.4	0°	○	○
GSTSB2R200N-U	2	16	0.05	2.2	9.5	4.4	0°	○	○

● Stock ○ Available upon order



GK Series

## External Holders for Parting and Grooving

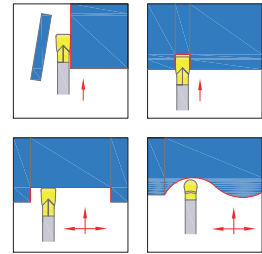
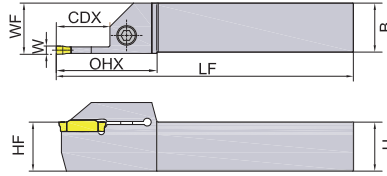

The picture is right hand holder

Ordering Code	Dimension(mm)						Insert	Screw	Wrench	Weight (KG)	Stock	
	W	CDX	H=HF	B	LF	WF					R	L
GKER/L1616-2T14	2.0	14	16	16	100	17	GKD20...	SCAM050200H	TH40LH	0.20	●	●
GKER/L2020-2T14	2.0	14	20	20	125	21	GKD20...	SCAM050200H	TH40LH	0.39	●	●
GKER/L2525-2T14	2.0	14	25	25	150	26	GKD20...	SCAM060250H	TH50LH	0.74	●	●
GKER/L1616-2.5T16	2.5	16	16	16	100	17	GKD25...	SCAM050200H	TH40LH	0.20	●	○
GKER/L2020-2.5T16	2.5	16	20	20	125	21	GKD25...	SCAM050200H	TH40LH	0.39	●	●
GKER/L2525-2.5T16	2.5	16	25	25	150	26	GKD25...	SCAM060250H	TH50LH	0.74	●	●
GKER/L1616-3T18	3.0	18	16	16	100	17	GKD30...	SCAM050200H	TH40LH	0.20	●	●
GKER/L1616-3T10	3.0	10	16	16	100	17	GKD30...	SCAM050200H	TH40LH	0.20	●	○
GKER/L2020-3T18	3.0	18	20	20	125	21	GKD30...	SCAM050200H	TH40LH	0.39	●	●
GKER/L2020-3T10	3.0	10	20	20	125	21	GKD30...	SCAM050200H	TH40LH	0.39	●	●
GKER/L2525-3T18	3.0	18	25	25	150	26	GKD30...	SCAM060250H	TH50LH	0.74	●	●
GKER/L2525-3T10	3.0	10	25	25	150	26	GKD30...	SCAM060250H	TH50LH	0.74	●	●
GKER/L3225-3T18	3.0	18	32	25	170	26	GKD30...	SCAM060250H	TH50LH	1.07	●	●
GKER/L3232-3T18	3.0	18	32	32	170	33	GKD30...	SCAM060250H	TH50LH	1.37	●	●
GKER/L2020-4T18	4.0	18	20	20	125	21	GKD40...	SCAM050200H	TH40LH	0.39	●	●
GKER/L2020-4T10	4.0	10	20	20	125	21	GKD40...	SCAM050200H	TH40LH	0.39	●	●
GKER/L2525-4T18	4.0	18	25	25	150	26	GKD40...	SCAM060250H	TH50LH	0.74	●	●
GKER/L2525-4T10	4.0	10	25	25	150	26	GKD40...	SCAM060250H	TH50LH	0.74	●	●
GKER/L3225-4T18	4.0	18	32	25	170	26	GKD40...	SCAM060250H	TH50LH	1.07	●	●
GKER/L3232-4T18	4.0	18	32	32	170	33	GKD40...	SCAM060250H	TH50LH	1.37	●	●

Note: SCAM060200H stands for M6X20



● Stock ○ Available upon order

GK Series

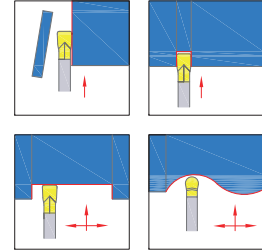
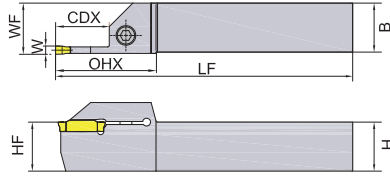
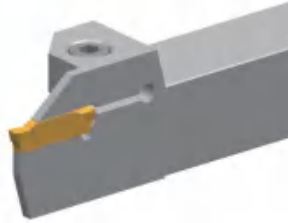
External Holders for Parting and Grooving



The picture is right hand holder

Ordering Code	Dimension(mm)						Insert	Screw 	Wrench 	Weight (KG)	Stock	
	W	CDX	H=HF	B	LF	WF					R	L
GKER/L2020-5T23	5.0	23	20	20	125	21	GKD50...	SCAM050200H	TH40LH	0.39	●	●
GKER/L2020-5T15	5.0	15	20	20	125	21	GKD50...	SCAM050200H	TH40LH	0.39		○
GKER/L2525-5T23	5.0	23	25	25	150	26	GKD50...	SCAM060250H	TH50LH	0.74	●	●
GKER/L2525-5T15	5.0	15	25	25	150	26	GKD50...	SCAM060250H	TH50LH	0.74	●	●
GKER/L3225-5T23	5.0	23	32	25	170	26	GKD50...	SCAM060250H	TH50LH	1.07	●	●
GKER/L3232-5T23	5.0	23	32	32	170	33	GKD50...	SCAM060250H	TH50LH	1.37	●	●
GKER/L3232-5T15	5.0	15	32	32	170	33	GKD50...	SCAM060250H	TH50LH	1.37	●	●
GKER/L2020-6T23	6.0	23	20	20	125	21	GKD60...	SCAM050200H	TH40LH	0.39	●	○
GKER/L2525-6T23	6.0	23	25	25	150	26	GKD60...	SCAM060250H	TH50LH	0.74	●	●
GKER/L2525-6T15	6.0	15	25	25	150	26	GKD60...	SCAM060250H	TH50LH	0.74	●	●
GKER/L3225-6T23	6.0	23	32	25	170	26	GKD60...	SCAM060250H	TH50LH	1.07	●	●
GKER/L3232-6T23	6.0	23	32	32	170	33	GKD60...	SCAM060250H	TH50LH	1.37	●	●
GKER/L2525-8T28	8.0	28	25	25	150	26.5	GKD80...	SCAM060250H	TH50LH	0.74	●	○
GKER/L2525-8T15	8.0	15	25	25	150	26.5	GKD80...	SCAM060250H	TH50LH	0.74	○	○
GKER/L3232-8T28	8.0	28	32	32	170	33.5	GKD80...	SCAM060250H	TH50LH	1.37	●	○

Note: SCAM060200H stands for M6X20



●Stock ○Available upon order

GK Series

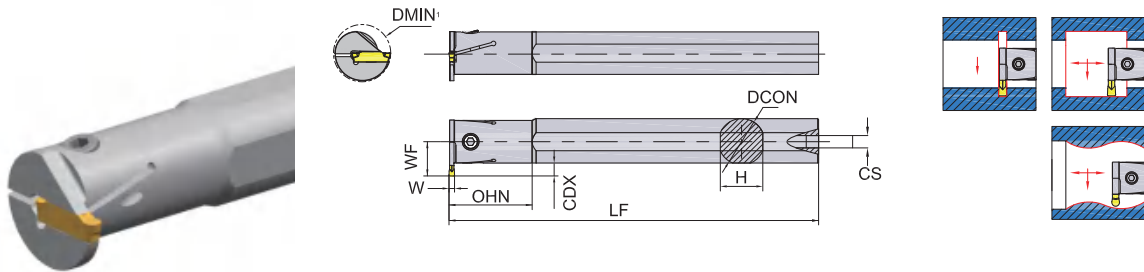
## Internal Holders for Grooving



The picture is right hand holder

Ordering Code	Dimension(mm)								Insert	Screw 	Wrench 	Weight (KG)	Stock	
	W	CDX	DMIN1	DCON	WF	LF	OHN	H					R	L
GKIR/L2016-2T04	2.0	4	20	16	12	125	35	15	GKD20...	SCAM040160H	TH30LH	0.20	●	●
GKIR/L2520-2T05	2.0	5	25	20	14.5	150	45	18	GKD20...	SCAM040160H	TH30LH	0.37	●	●
GKIR/L2925-2T05	2.0	5	29	25	17	200	45	23	GKD20...	SCAM050200H	TH40LH	0.77	●	●
GKIR/L2520-2.5T05	2.5	5	25	20	14.5	150	45	18	GKD25...	SCAM040160H	TH30LH	0.37	●	○
GKIR/L2925-2.5T05	2.5	5	29	25	17	200	45	23	GKD25...	SCAM050200H	TH40LH	0.77	●	●
GKIR/L2520-3T06	3.0	6	25	20	15.5	150	45	18	GKD30...	SCAM040160H	TH30LH	0.37	●	●
GKIR/L3125-3T06	3.0	6	31	25	18.5	200	45	23	GKD30...	SCAM050200H	TH40LH	0.77	●	●
GKIR/L3732-3T06	3.0	6	37	32	21.5	250	65	30	GKD30...	SCAM050200H	TH40LH	1.58	●	●
GKIR/L2520-4T06	4.0	6	25	20	15.5	150	45	18	GKD40...	SCAM040160H	TH30LH	0.37	●	●
GKIR/L3125-4T06	4.0	6	31	25	18.5	200	45	23	GKD40...	SCAM050200H	TH40LH	0.77	●	●
GKIR/L3732-4T06	4.0	6	37	32	21.5	250	65	30	GKD40...	SCAM050200H	TH40LH	1.58	●	●
GKIR/L3125-5T08	5.0	8	31	25	19.5	200	45	23	GKD50...	SCAM050200H	TH40LH	0.77	●	●
GKIR/L3732-5T08	5.0	8	37	32	21.5	250	65	30	GKD50...	SCAM050200H	TH40LH	1.58	●	●
GKIR/L3125-6T08	6.0	8	31	25	19.5	200	45	23	GKD60...	SCAM050200H	TH40LH	0.77	●	○
GKIR/L3732-6T08	6.0	8	37	32	21.5	250	65	30	GKD60...	SCAM050200H	TH40LH	1.58	●	●
GKIR/L3732-8T10	8.0	10	37	32	23.4	250	65	30	GKD80...	SCAM050200H	TH40LH	1.58	○	○
GKIR/L4540-8T10	8.0	10	45	40	27.2	300	70	37	GKD80...	SCAM050200H	TH40LH	2.96	○	○

Note: SCAM060200H stands for M6X20

●Stock ○Available upon order



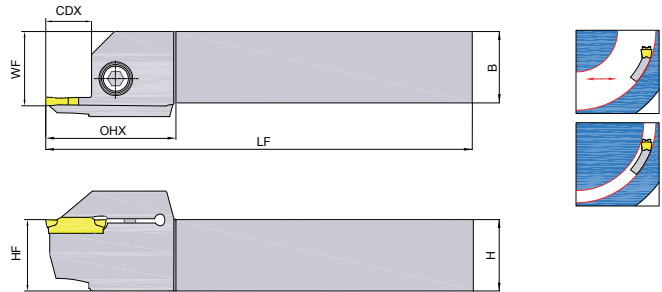
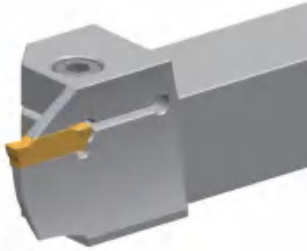

GK Series

## Face Grooving Holders-Horizontal



The picture is right hand holder

Ordering Code	Dimension(mm)							Insert	Screw 	Wrench 	Weight (KG)	Stock	
	H=HF	B	LF	WF	CDX	DMIN1	DMAX1					R	L
GKFR/L2525-2T12D75	25	25	150	26	12	75	100	GKD20...	SCAM060200H	TH50LH	0.72		○
GKFR/L2525-2T12D90	25	25	150	26	12	90	150	GKD20...	SCAM060200H	TH50LH	0.74	●	○
GKFR/L2525-3T15D68	25	25	150	26	15	68	100	GKD30...	SCAM060200H	TH50LH	0.74	●	○
GKFR/L2525-3T15D90	25	25	150	26	15	90	160	GKD30...	SCAM060200H	TH50LH	0.74	●	○
GKFR/L2020-4T15D62	20	20	150	26	15	62	120	GKD40...	SCAM050160H	TH40LH	0.39	●	○
GKFR/L2525-4T15D62	25	25	150	26	15	62	120	GKD40...	SCAM060200H	TH50LH	0.74	●	●
GKFR/L2525-4T15D112	25	25	150	26	15	112	200	GKD40...	SCAM060200H	TH50LH	0.74	●	●
GKFR/L2525-4T25D62	25	25	150	26	25	62	120	GKD40...	SCAM060200H	TH50LH	0.74	○	
GKFR/L2525-5T10D150	25	25	150	26	10	150	300	GKD50...	SCAM060200H	TH50LH	0.74		●
GKFR/L2525-5T25D68	25	25	150	26	25	68	95	GKD50...	SCAM060200H	TH50LH	0.74	○	○
GKFR/L2525-5T25D85	25	25	150	26	25	85	130	GKD50...	SCAM060200H	TH50LH	0.74	○	○
GKFR/L2525-6T25D68	25	25	150	26	25	68	100	GKD60...	SCAM060200H	TH50LH	0.74		○
GKFR/L2525-6T25D88	25	25	150	26	25	88	180	GKD60...	SCAM060200H	TH50LH	0.74	●	●
GKFR/L2525-8T25D45	25	25	150	26	25	45	80	GKD80...	SCAM060200H	TH50LH	0.74	○	

Note: SCAM060200H stands for M6X20



● Stock ○ Available upon order

GK Series

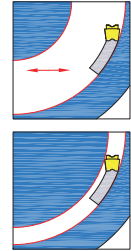
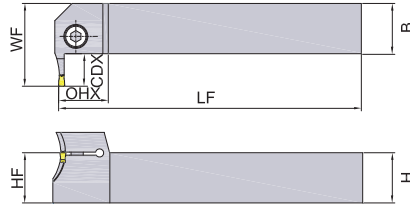
Face Grooving Holders-Perpendicular



The picture is right hand holder

Ordering Code	Dimension(mm)							Insert	Screw 	Wrench 	Weight (KG)	Stock	
	H=HF	B	LF	WF	CDX	DMIN1	DMAX1					R	L
GKFPR/L2525-4T15D60	25	25	150	26	15	60	120	GKD40...	SCAM060200H	TH50LH	0.74	●	●
GKFPR/L2525-4T15D112	25	25	150	26	15	112	200	GKD40...	SCAM060200H	TH50LH	0.74	●	●

Note: SCAM060200H stands for M6X20



● Stock ○ Available upon order

GZ Series

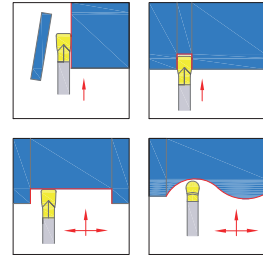
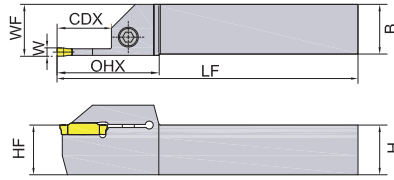
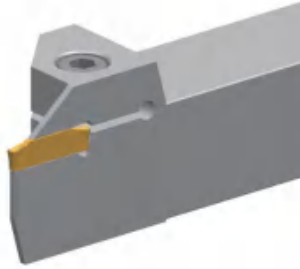
External Holders for Parting and Grooving



The picture is right hand holder

Ordering Code	Dimension(mm)						Insert	Screw 	Wrench 	Weight (KG)	Stock	
	W	CDX	H=HF	B	LF	WF					R	L
GZER/L2020-3T20	3.0	20	20	20	125	21	GZD30...	SCAM050200H	TH40LH	0.39	●	●
GZER/L2525-3T20	3.0	20	25	25	150	26	GZD30...	SCAM060250H	TH50LH	0.74	●	●
GZER/L3225-3T20	3.0	20	32	25	170	26	GZD30...	SCAM060250H	TH50LH	1.07	○	○
GZER/L2020-4T25	4.0	25	20	20	125	21	GZD40...	SCAM050200H	TH40LH	0.39	●	○
GZER/L2020-4T25	5.0	25	20	20	125	21.5	GZD50...	SCAM050200H	TH40LH	0.39	●	○
GZER/L2525-4T20	4.0	20	25	25	150	26	GZD40...	SCAM060250H	TH40LH	0.74	●	
GZER/L2525-4T20	5.0	20	25	25	150	26.5	GZD50...	SCAM060250H	TH40LH	0.74	●	
GZER/L2525-4T25	4.0	25	25	25	150	26	GZD40...	SCAM060250H	TH50LH	0.74	●	●
GZER/L2525-4T25	5.0	25	25	25	150	26.5	GZD50...	SCAM060250H	TH50LH	0.74	●	●
GZER/L3225-4T25	4.0	25	32	25	170	26	GZD40...	SCAM060250H	TH50LH	1.07	●	●
GZER/L3225-4T25	5.0	25	32	25	170	26.5	GZD50...	SCAM060250H	TH50LH	1.07	●	●
GZER/L2525-6T32	6.0	32	25	25	150	26	GZD60...	SCAM060250H	TH50LH	1.07	●	●
GZER/L3225-6T32	6.0	32	32	25	170	26	GZD60...	SCAM060250H	TH50LH	1.07	○	○

Note: SCAM060200H stands for M6X20



● Stock ○ Available upon order

GB Series

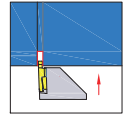
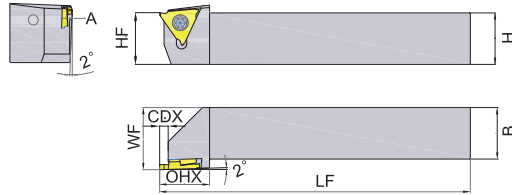
External Holders for Grooving



The picture is right hand holder

Ordering Code	Dimension(mm)						Insert	Screw 	Wrench 	Weight (KG)	Stock	
	H=HF	B	LF	WF	A	CDX					R	L
GBER/L2020K3	20	20	125	25	—	2.5	GB3...	SI60M 035120-05316	PTT15PH	0.39	●	○
GBER/L2525M3	25	25	150	30	—	2.5	GB3...	SI60M 035120-05316	PTT15PH	0.74	●	●
GBER/L2020K4-15	20	20	125	25	1.0	4.0	GB4... (1.0 ≤ W < 2.5)	SI60M 050120-07217	PTT20PH	0.39	●	●
GBER/L2525M4-15	25	25	150	30	1.0	4.0	GB4... (1.0 ≤ W < 2.5)	SI60M 050120-07217	PTT20PH	0.74	●	●
GBER/L2020K4-25	20	20	125	25	2.0	4.5	GB4... (2.5 ≤ W < 3.3)	SI60M 050120-07217	PTT20PH	0.39	●	○
GBER/L2525M4-25	25	25	150	30	2.0	4.5	GB4... (2.5 ≤ W < 3.3)	SI60M 050120-07217	PTT20PH	0.74	○	○
GBER/L2020K4-35	20	20	125	25	3.0	5.5	GB4... (3.3 ≤ W < 4.3)	SI60M 050120-07217	PTT20PH	0.39	○	○
GBER/L2525M4-35	25	25	150	30	3.0	5.5	GB4... (3.3 ≤ W < 4.3)	SI60M 050120-07217	PTT20PH	0.74	●	○

Note: SI60M 035120... stands for M3.5X12.



● Stock ○ Available upon order

GB Series

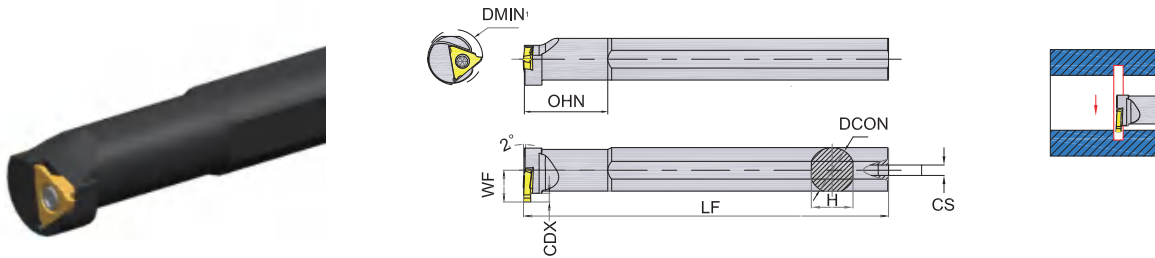
Internal Holders for Grooving



The picture is right hand holder

Ordering Code	Dimension(mm)						Insert	Screw 	Wrench 	Weight (KG)	Stock	
	DMIN1	DCON	H	LF	WF	CDX					R	L
GBIR/L2620Q3	26	20	18	180	13	3	GB3...	SI60M 035120-05316	PTT15PH	0.44	●	○
GBIR/L3525R4	35	25	23	200	17.5	4.5	GB4...	SI60M 050120-07217	PTT20PH	0.77	●	●

Note: SI60M 035120... stands for M3.5X12.

● Stock ○ Available upon order

External Tool Holders

G-Notch Series

# GNS

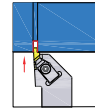
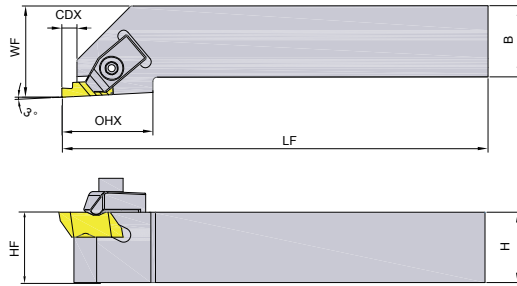

The picture is right hand holder

Ordering Code	Dimension (mm)						Insert	Screw	Clamp	Wrench	Weight (KG)	Stock	
	H	B	WF	LF	OHX	CDX						R	L
GNSR/L1616H2	16	16	20	100	19	3.5	GN.2	SCAM040120H	CAN02RH	TH30LH	0.20	●	○
GNSR/L 2020K2	20	20	25	125	19	3.5	GN.2	SCAM040120H	CAN02RH	TH30LH	0.38	○	○
GNSR/L 2525M2	25	25	32	150	19	3.5	GN.2	SCAM040120H	CAN02RH	TH30LH	0.74	○	○
GNSR/L 2020K3	20	20	25	125	32	5.3	GN.3	SCAM050200H	CAN03RH	TH40LH	0.39	●	○
GNSR/L 2525M3	25	25	32	150	32	5.3	GN.3	SCAM050200H	CAN03RH	TH40LH	0.74	●	●

● Stock ○ Available upon order

External Tool Holders

# GNR

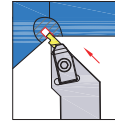
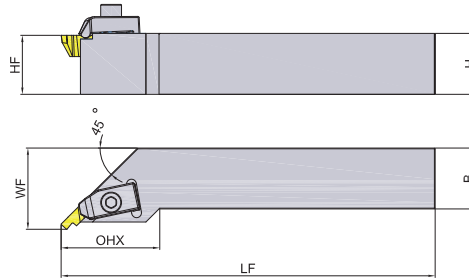

The picture is right hand holder

Ordering Code	Dimension (mm)				Insert	Screw	Clamp	Wrench	Weight (KG)	Stock	
	H	B	WF	LF						R	L
GNRR/L2020K3	20	20	25	125	GN.3	SCAM050200H	CAN03RH	TH40LH	0.38	<input type="radio"/>	<input type="radio"/>
GNRR/L2525M3	25	25	32	150	GN.3	SCAM050200H	CAN03RH	TH40LH	0.39	<input type="radio"/>	<input type="radio"/>

Note: Left hand holders go with right hand inserts, right hand holders go with left hand inserts.

● Stock ○ Available upon order

# GNE

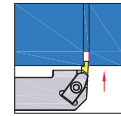
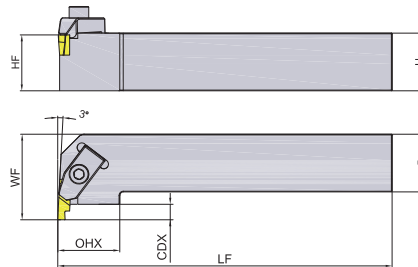

The picture is right hand holder

Ordering Code	Dimension (mm)					Insert	Screw	Clamp	Wrench	Weight (KG)	Stock	
	H	B	WF	LF	CDX						R	L
GNER/L2020K2	20	20	25	125	3.5	GN.2	SCAM040120H	CAN02RH	TH30LH	0.38	<input type="radio"/>	<input type="radio"/>
GNER/L2525M2	25	25	32	150	3.5	GN.2	SCAM040120H	CAN02RH	TH30LH	0.39	<input type="radio"/>	<input type="radio"/>
GNER/L2525M3	25	25	32	150	5.3	GN.3	SCAM050200H	CAN03RH	TH40LH	0.39	<input type="radio"/>	<input type="radio"/>

Note: Left hand holders go with right hand inserts, right hand holders go with left hand inserts.

● Stock ○ Available upon order

Internal Tool Holders

G-Notch Series

# GNA

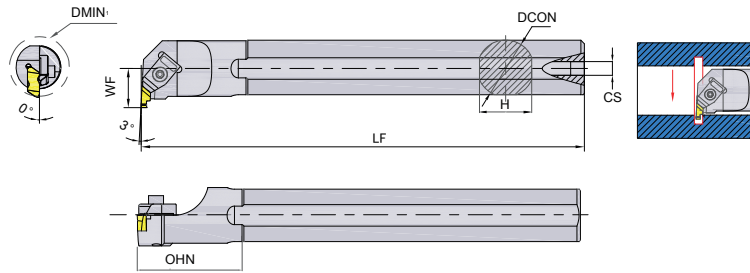

The picture is right hand holder

Ordering Code	Dimension (mm)					Insert	Screw	Clamp	Wrench	Weight (KG)	Stock	
	DCON	DMIN1	LF	WF	CS						R	L
GNAR20Q2	20	26	180	13	1/8-27 NPT	GN.2L	SCAM040120H	CAN02LH	TH30LH	0.44	○	●
GNAR25R2	25	34	200	17	1/4-18 NPT	GN.2L	SCAM040120H	CAN02LH	TH30LH	0.77	○	○
GNAR25R3	25	34	200	17	1/4-18 NPT	GN.3L	SCAM050200H	CAN03LH	TH40LH	0.77	○	○

Note: Left hand holders go with right hand inserts, right hand holders go with left hand inserts.

● Stock ○ Available upon order



Small Parts Tool Holders

GST Series

# GST

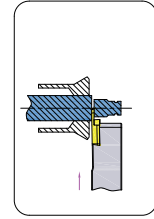
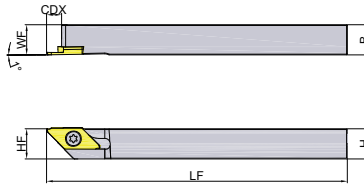

Ordering Code	Dimension (mm)						Insert	Screw	Wrench	Weight (KG)	Stock	
	H	B	LF	HF	WF	CDX					R	L
GSTR/L1010JK3	10	10	120	10	10	6	GST*3R/L**	SSAM045095Q	TT10PQ	0.09	●	○
GSTR/L1010JK4	10	10	120	10	10	8	GST*4R/L**	SSAM045095Q	TT10PQ	0.09	●	○
GSTR/L1212JK3	12	12	120	12	12	6	GST*3R/L**	SSAM045095Q	TT10PQ	0.14	●	○
GSTR/L1212JK4	12	12	120	12	12	8	GST*4R/L**	SSAM045095Q	TT10PQ	0.14	●	○
GSTR/L1616JK3	16	16	120	16	16	6	GST*3R/L**	SSAM045095Q	TT10PQ	0.24	●	○
GSTR/L1616JK4	16	16	120	16	16	8	GST*4R/L**	SSAM045095Q	TT10PQ	0.24	●	○
GSTR/L2020JK3	20	20	120	20	20	6	GST*3R/L**	SSAM045095Q	TT10PQ	0.40	●	○
GSTR/L2020JK4	20	20	120	20	20	8	GST*4R/L**	SSAM045095Q	TT10PQ	0.40	●	○

● Stock ○ Available upon order

# GST-RS

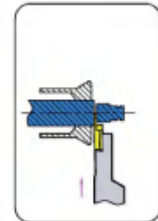
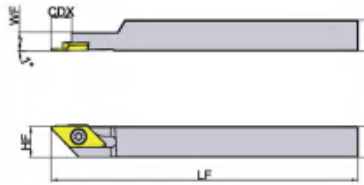

Ordering Code	Dimension (mm)						Insert	Screw	Wrench	Weight (KG)	Stock	
	H	B	LF	HF	WF	CDX					R	L
GSTR/L1010JK3-RS	10	10	120	10	7.2	6	GST*3R/L**	SSAM045070Q	TT10PQ	0.09	●	○
GSTR/L1212JK3-RS	12	12	120	12	7.2	6	GST*3R/L**	SSAM045070Q	TT10PQ	0.14	●	○
GSTR/L1010JK4-RS	10	10	120	10	7.2	8	GST*4R/L**	SSAM045070Q	TT10PQ	0.09	●	○
GSTR/L1212JK4-RS	12	12	120	12	7.2	8	GST*4R/L**	SSAM045070Q	TT10PQ	0.14	●	○

● Stock ○ Available upon order

# Recommended Cutting Data

## Recommend Feed

### MT

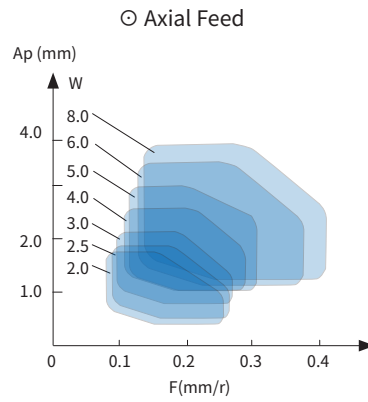
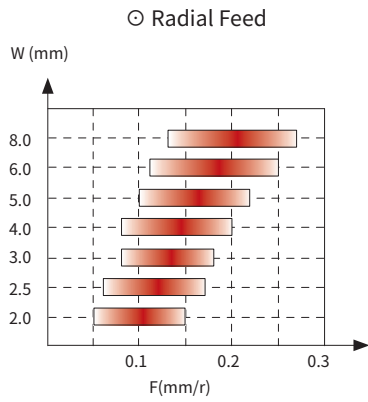

### MR

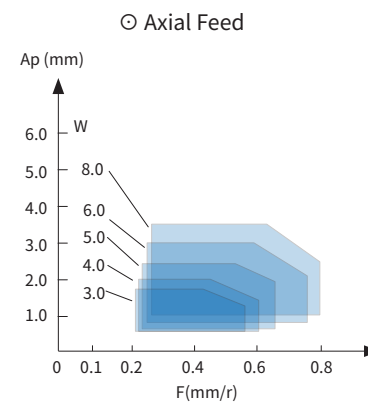
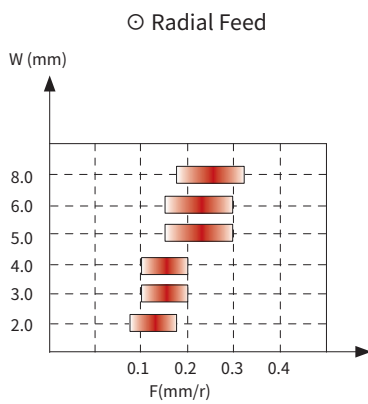

### FG

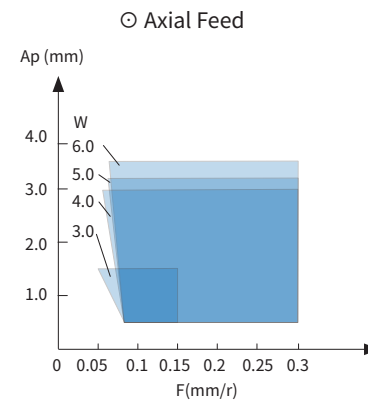
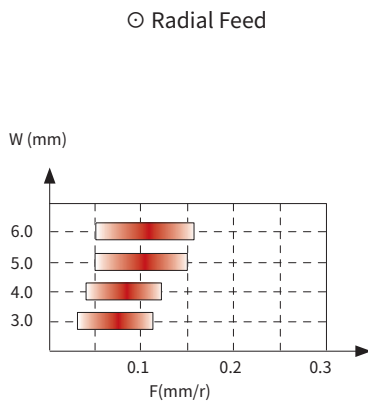

## OR

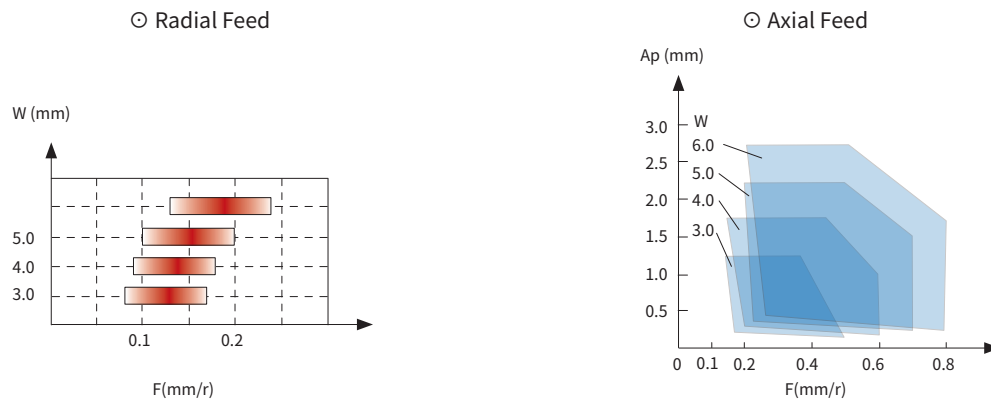

## GB

ISO	Workpiece Material	Feed (mm/r)				
		Width (mm)				
		0.5-1.0	1.0-2.0	2.5-3.0	3.3-4.0	4.0-4.3
<b>P</b>	Carbon Steel	①.0.03~0.08	①.0.04~0.09 ②.0.04~0.09	①.0.05~0.10 ②.0.05~0.10	①.0.05~0.12 ②.0.05~0.10	①.0.05~0.12 ②.0.05~0.10
	Alloy Steel	①.0.03~0.07	①.0.04~0.08 ②.0.04~0.08	①.0.05~0.09 ②.0.05~0.09	①.0.05~0.10 ②.0.05~0.10	①.0.05~0.10 ②.0.05~0.10
<b>M</b>	Stainless Steel	①.0.03~0.07	①.0.04~0.08 ②.0.04~0.08	①.0.05~0.09 ②.0.05~0.09	①.0.05~0.10 ②.0.05~0.10	①.0.05~0.10 ②.0.05~0.10
<b>K</b>	Cast Iron	①.0.03~0.08	①.0.04~0.09 ②.0.04~0.09	①.0.05~0.10 ②.0.05~0.10	①.0.05~0.12 ②.0.05~0.10	①.0.05~0.12 ②.0.05~0.10

①Radial Feed ②Axial Feed

## G-Notch

Width (mm)	Feed (mm/r)
0.79-1.50	0.08 (0.03-0.12)
1.50-2.50	0.10 (0.04-0.16)
2.50-3.50	0.12 (0.05-0.20)
3.50-4.50	0.14 (0.05-0.25)

## Recommended Cutting Data

### Recommended Cutting Speed

ISO	Workpiece Material	Hardness (HB)	Cutting Speed Vc (m/min)								
			GA4230	GA4330	GP1225	GP1105	GK1115	GS3115	GS3125	GS9125	GM3225
<b>P</b>	Low Carbon Steel	80 – 170	110 (70-180)	120 (80-220)	120 (80-220)	120 (80-220)		70 (50-100)	70 (50-100)		110 (70-180)
	High Carbon Steel	170 – 250	110 (70-150)	120 (80-220)	120 (80-220)	120 (80-220)					110 (70-160)
	Low-alloy Steel	140– 260	110 (40-150)	110 (60-180)	110 (60-180)	110 (60-180)		70 (50-100)	70 (50-100)		110 (60-160)
	High-alloy Steel	180– 300	110 (40-150)	110 (60-180)	110 (60-180)	110 (60-180)					110 (60-160)
	Cast Steel	180– 300	110 (40-150)	110 (60-180)	110 (60-180)	110 (60-180)					
<b>M</b>	Ferritic/ Martensitic	150– 270	110 (40-180)	110 (40-180)				90 (50-150)	90 (30-180)		100 (40-180)
	Austenitic	150– 270	110 (40-180)	110 (40-180)				90 (50-150)	90 (30-180)		100 (40-180)
<b>K</b>	Malleable Cast Iron	150– 230	110 (50-180)	110 (50-180)			130 (50-200)				180 (70-300)
	Gray Cast Iron	150– 230	110 (50-180)	110 (50-180)			130 (50-200)				180 (70-300)
	Nodular Cast Iron	160– 260	100 (50-150)	100 (50-150)			100 (50-150)				160 (60-300)
<b>S</b>	Heat-resistant Alloy	130– 400						35 (15-60)	35 (15-70)		
	Titanium Alloys	130– 400						35 (15-60)	35 (15-70)	35 (15-60)	

### GST Series Recommended Cutting Datas

ISO	Workpiece Material	Hardness (HB)	Serie	Grade	Cutting Speed Vc(m/min)	Feed (mm/r)
<b>P</b>	Steel	≤300	GSTC	GAT7115	120(60-180)	0.02(0.01-0.03)
				GAT7125	90(40-150)	
			GSTS	GAT7115	120(60-180)	0.02(0.01-0.03)
				GAT7125	90(40-150)	
<b>M</b>	Stainless Steel	≤300	GSTC	GAT7115	100(60-150)	0.015(0.01-0.02)
				GAT7125	80(40-130)	
			GSTS	GAT7115	100(60-150)	0.015(0.01-0.02)
				GAT7125	80(40-130)	

G

THREADING TOOLS



## Threading Insert Identification System

# 16 E R 1.50 ISO - TC

①

②

③

④

⑤

⑥

① Insert Size	
Size	IC(mm)
08	5
11	6.35
16	9.525
22	12.7
27	15.875

③ Hand of Insert
R=Right hand
L=Left Hand
<input type="checkbox"/> =Left or right hand

⑤ Thread Standard
60=Partial Profile 60° Thread
55=Partial Profile 55° Thread
ISO=ISO Metric Thread
UN=American UN Thread
W=Whitworth Thread
NPT=NPT Thread
BSPT=British Standard Pipe Thread
RD=Round Thread
TR=Trapezoidal Thread
ACME=American ACME
STACME=American Stub ACME
ABUT=American buttless Thread
BBUT=British Buttress Thread
SAGE=Metric Buttress Thread
API=API Thread
BUT=API buttress thread casing
APIRD=API Round thread for piping and casing
MJ=Metric Aerospace Thread
UNJ=American Aerospace Thread

⑥ Additional Information
Geometry or Teeth

② Thread Style
E=External
I=Internal
<input type="checkbox"/> =E&I

④ Pitch		
Full Profile		
mm	TPI	
0.35-5.0	72-5	
Partial Profile		
Size	mm	TPI
A	0.5-1.5	48-16
AG	0.5-3.0	48-8
G	1.75-3.0	14-8
N	3.5-5.0	7-5

## G-NOTCH Series Insert Identification System

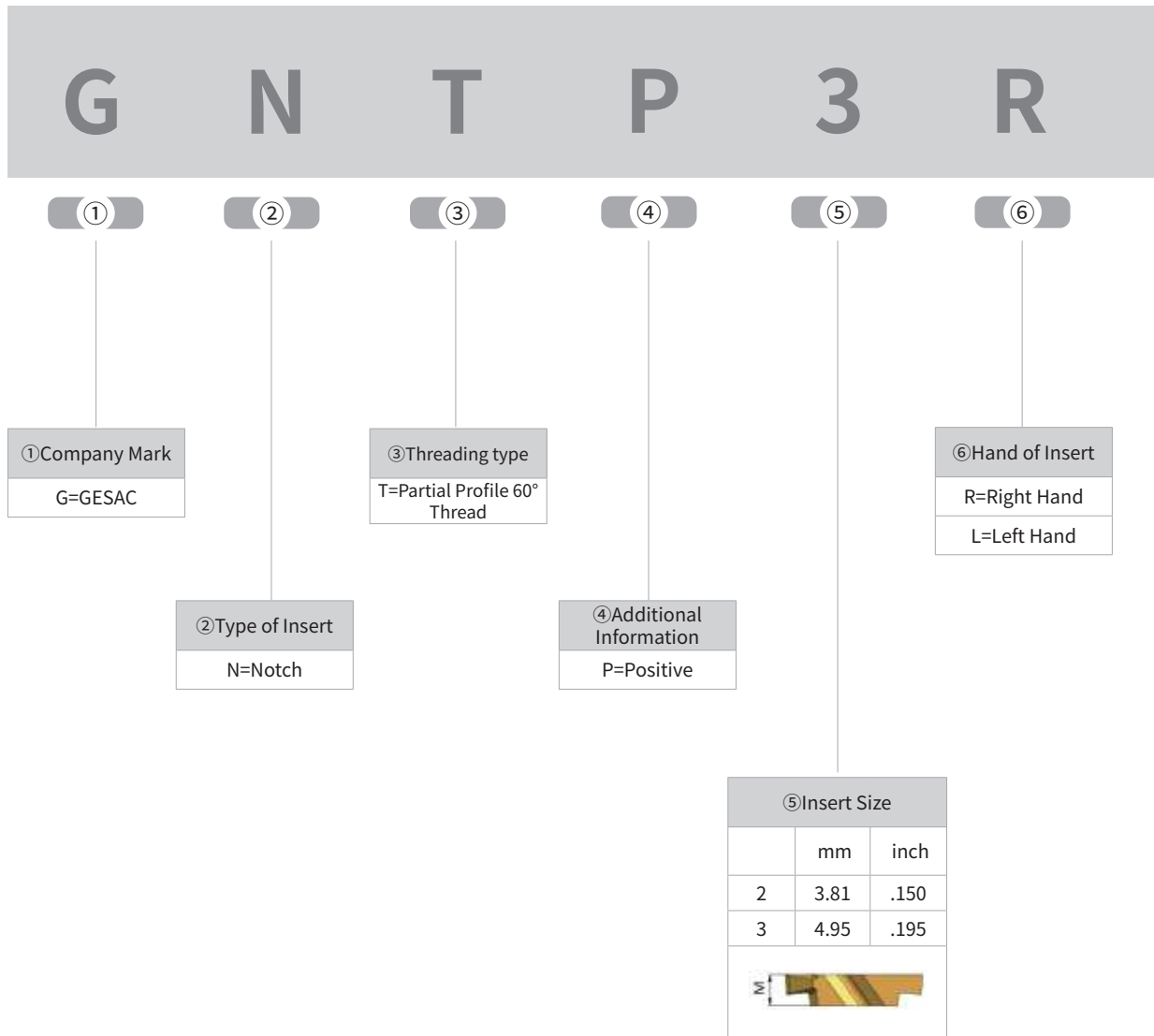

## GST Series Insert Identification System

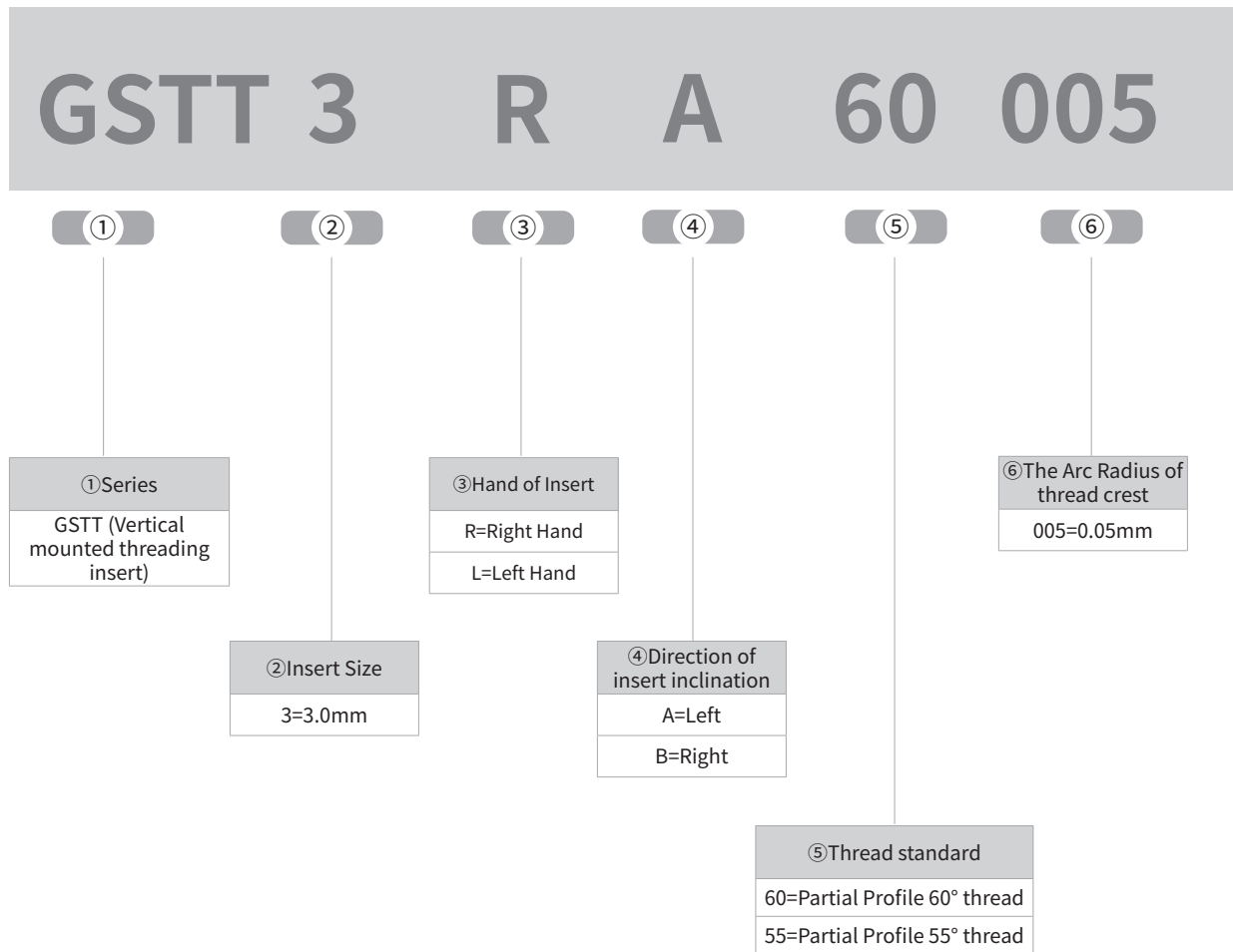



# Threading Holder Identification System

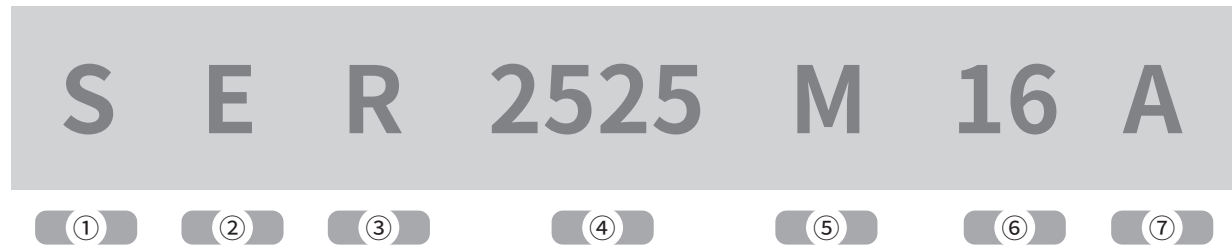

① Clamping System	
S	Screw
C	Clamp

② Process Type	
E	External
I	Internal

③ Cutting Direction	
R	Right hand
L	Left hand
N	R&L

④ Shank Size(mm)	
External Holder	
Shank Size	hxb
2525	25×25mm
Internal Bar	
Shank Size	Diameter
0025	25mm

⑤ Shank Length (mm)	
H	100
K	125
M	150
N	160
P	170
Q	180
R	200
S	250
T	300
U	350
V	400

⑥ Insert Size	
Type	IC(mm)
08	5
11	6.35
16	9.525
22	12.7
27	15.875

⑦ Additional Information	
A	Steel holder with inner coolant
C	Carbide holder
E	Carbide holder with inner coolant
<input type="checkbox"/>	Steel holder without inner coolant

## G-NOTCH External Holder Identification System

G
N
S
R
2525
M
3

①

②

③

④

⑤

⑥

⑦

**① Company Mark**

G=GESAC

**③ Insert Mounting Location**

S=Side



**⑤ Shank Size**

Width	Height
12mm	12mm
16mm	16mm
20mm	20mm
25mm	25mm
32mm	32mm

**⑥ Shank length**

D	60mm
E	70mm
F	80mm
H	100mm
K	125mm
M	150mm
P	170mm
Q	180mm
R	200mm

**② Clamping System**

N=Notch



**④ Hand of Tool**

L=Left Hand



R=Right Hand



**⑦ Insert Size**

	mm	inch
2	3.81	.150
3	4.95	.195



## G-NOTCH Internal Holder Identification System

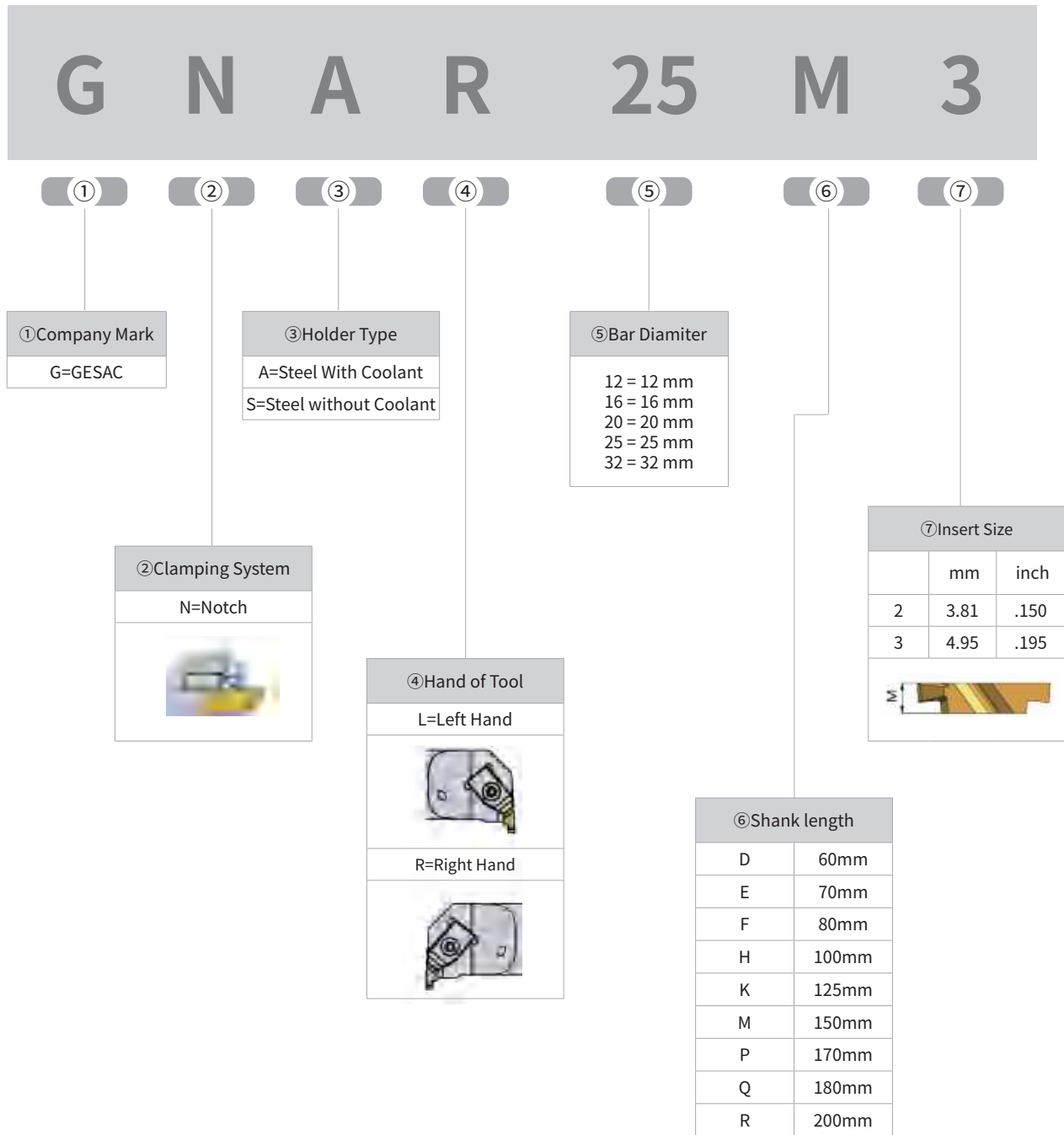





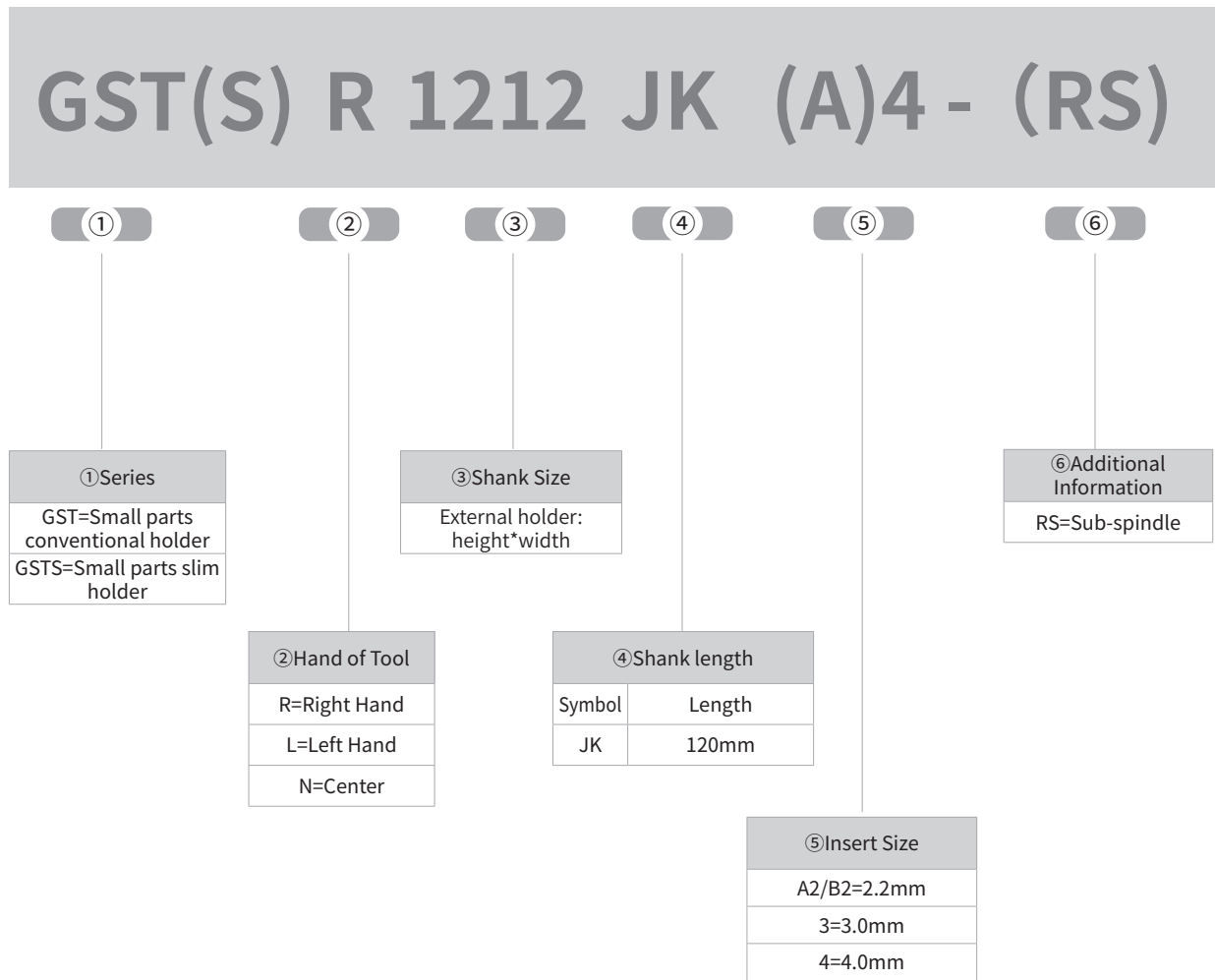



Note: Left hand bars use right hand inserts, Right hand bars use left hand inserts.









## GST series Holder Identification System



## Overview of Threading Inserts

Application	Thread Type	Thread Sketch	Thread Code	Pitch	Page
General Industry	Partial Profile 60° Thread		60°	0.5-5.0 (mm)	P213
	Partial Profile 55° Thread		55°	48-5 (TPI)	P214
	ISO Metric Thread		ISO	0.5-6.0 (mm)	P215 - P216
	American UN Thread		UN	24-8 (TPI)	P217
Thread fir pipe fittings and couplings for gas, water and sewage	Whitworth Thread		W	19-8 (TPI)	P218
	NPT Thread		NPT	27-8 (TPI)	P219
Thread for pipe fittings and couplings for gas, steam and water lines	British Standard Pipe Thread		BSPT	28-11 (TPI)	P220
Thread for pipe couplings in food and Fire Fighting	Round D405 Thread		RD	8-4 (TPI)	P221

## Overview of Threading Inserts

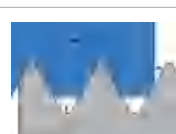
Application	Thread Type	Thread Sketch	Thread Code	Pitch	Page
Mechanical Transmission	Trapezoidal Thread		TR	1.5-6.0 (mm)	P222
	American ACME Thread		ACME	12-4 (TPI)	P223
	American Stub ACME Thread		STACME	8-4 (TPI)	P224
	Metric Buttress Thread		SAGE	4 (mm)	P225
	American Buttress Thread		ABUT	16 (TPI)	P225
Petroleum Standard thread	API Thread		API	4 (TPI)	P226
Petroleum, gas, casing pipe and oil pipe	API Round thread for piping and casing		APIRD	10-8 (TPI)	P227
Aviation	Metric Aerospace Thread		MJ	1.0-2.0 (mm)	P228
	American Aerospace Thread		UNJ	32-16 (TPI)	P229

# Partial Profile 60°

## ► External

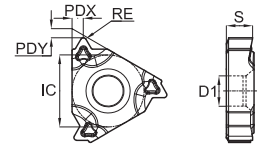



Ordering Code	Pitch (TPI)	Dimension (mm)							Coated Carbide
		PDY	PDX	RE	IC	S	D1	GM3225	
	16 ERA60-TC	0.5-1.5	0.8	0.9	0.08	9.525	3.47	4	●
	16 ERAG60-TC	0.5-3.0	1.1	1.5	0.08	9.525	3.47	4	●
	16 ERG60-TC	1.75-3.0	1.2	1.7	0.25	9.525	3.47	4	●
	22 ERN60-TC	3.5-5.0	1.7	2.5	0.51	12.7	4.71	5	●

● Stock ○ Available Upon Order

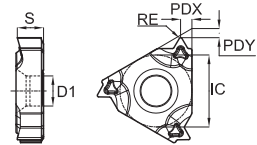
## ► Internal





Ordering Code	Pitch (TPI)	Dimension (mm)							Coated Carbide
		PDY	PDX	RE	IC	S	D1	GM3225	
	08 IRA60-TC	0.5-1.5	0.6	0.7	0.08	5.00	2.25	2.68	●
	11 IRA60-TC	0.5-1.5	0.8	0.9	0.08	6.35	3.00	3.2	●
	16 IRA60-TC	0.5-1.5	0.8	0.9	0.08	9.525	3.47	4	●
	16 IRAG60-TC	0.5-3.0	1.1	1.5	0.08	9.525	3.47	4	●
	16 IRG60-TC	1.75-3.0	1.2	1.7	0.13	9.525	3.47	4	●
	22 IRN60-TC	3.5-5.0	1.7	2.5	0.25	12.7	4.71	5	●
	22IRN60	3.5-5.0	1.8	2.5	0.36	12.7	4.71	5	●

● Stock ○ Available Upon Order

## Partial Profile 55°

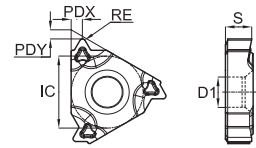
► External



Ordering Code	Pitch (TPI)	Dimension (mm)							Coated Carbide
		PDY	PDX	RE	IC	S	D1	GM3225	
	16 ERA55-TC	48-16	0.8	0.9	0.08	9.525	3.47	4	●
	16 ERAG55-TC	48-8	1.1	1.5	0.08	9.525	3.47	4	●
	16 ERG55-TC	14-8	1.2	1.7	0.21	9.525	3.47	4	●
	22 ERN55-TC	7-5	1.7	2.5	0.44	12.7	4.71	5	●

● Stock ○ Available Upon Order

► Internal

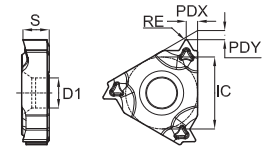

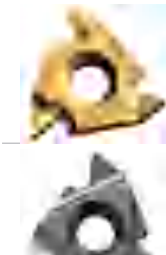
Ordering Code	Pitch (TPI)	Dimension (mm)							Coated Carbide
		PDY	PDX	RE	IC	S	D1	GM3225	
	11 IRA55-TC	48-16	0.8	0.9	0.08	6.35	3.00	3.2	●
	16 IRA55-TC	48-16	0.8	0.9	0.08	9.525	3.47	4	●
	16 IRAG55-TC	48-8	1.1	1.5	0.08	9.525	3.47	4	●
	16 IRG55-TC	14-8	1.2	1.7	0.21	9.525	3.47	4	●
	22 IRN55-TC	7-5	1.7	2.5	0.44	12.7	4.71	5	●
	08IRA55	48-16	0.6	0.7	0.08	5	2.25	2.68	●

● Stock ○ Available Upon Order



# Metric 60°

► External

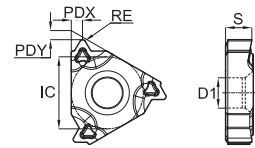

Ordering Code	Pitch (mm)	Dimension (mm)						Coated Carbide
		PDY	PDX	RE	IC	S	D1	GM3225
16 ER1.00ISO-TC	1.00	0.8	0.7	0.14	9.525	3.47	4	●
16 ER1.25ISO-TC	1.25	0.8	0.9	0.18	9.525	3.47	4	●
16 ER1.50ISO-TC	1.50	0.8	1.0	0.22	9.525	3.47	4	●
16 ER1.75ISO-TC	1.75	1.2	1.2	0.25	9.525	3.47	4	●
16 ER2.00ISO-TC	2.00	1.2	1.3	0.29	9.525	3.47	4	●
16 ER2.50ISO-TC	2.50	1.2	1.5	0.36	9.525	3.47	4	●
16 ER3.00ISO-TC	3.00	1.2	1.5	0.43	9.525	3.47	4	●
22 ER3.50ISO-TC	3.50	1.6	2.3	0.45	12.7	4.71	5	●
22 ER4.00ISO-TC	4.00	1.6	2.3	0.52	12.7	4.71	5	●
22 ER4.50ISO-TC	4.50	1.7	2.4	0.58	12.7	4.71	5	●
22 ER5.00ISO-TC	5.00	1.7	2.5	0.63	12.7	4.71	5	●
22 ER5.50ISO-TC	5.50	1.9	2.7	0.72	12.7	4.71	5	●
22 ER6.00ISO-TC	6.00	1.9	2.7	0.78	12.7	4.71	5	○
16EL1.50ISO	1.50	0.8	1.0	0.22	9.525	3.47	4	●
16EL2.00ISO	2.00	1.2	1.3	0.29	9.525	3.47	4	●
16ER0.50ISO	0.50	0.6	0.5	0.1	9.525	3.47	4	●
16ER1.00ISO	1.00	0.7	0.6	0.11	9.525	3.47	4	●



● Stock ○ Available Upon Order

# Metric 60°

► Internal

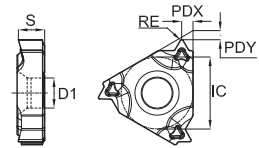



Ordering Code	Pitch (mm)	Dimension (mm)						Coated Carbide	
		PDY	PDX	RE	IC	S	D1	GM3225	
11 IR1.00ISO-TC	1.00	0.8	0.7	0.07	6.35	3.00	3.2	●	
11 IR1.25ISO-TC	1.25	0.8	0.9	0.09	6.35	3.00	3.2	●	
11 IR1.50ISO-TC	1.50	0.8	1.0	0.11	6.35	3.00	3.2	●	
11 IR1.75ISO-TC	1.75	0.9	1.1	0.13	6.35	3.00	3.2	●	
11 IR2.00ISO-TC	2.00	0.9	1.1	0.15	6.35	3.00	3.2	●	
16 IR1.00ISO-TC	1.00	0.8	0.7	0.07	9.525	3.47	4	●	
16 IR1.25ISO-TC	1.25	0.8	0.9	0.09	9.525	3.47	4	●	
16 IR1.50ISO-TC	1.50	0.8	1.0	0.11	9.525	3.47	4	●	
16 IR1.75ISO-TC	1.75	1.2	1.2	0.13	9.525	3.47	4	●	
16 IR2.00ISO-TC	2.00	1.2	1.3	0.15	9.525	3.47	4	●	
16 IR2.50ISO-TC	2.50	1.2	1.5	0.18	9.525	3.47	4	●	
16 IR3.00ISO-TC	3.00	1.2	1.5	0.22	9.525	3.47	4	●	
22 IR3.50ISO-TC	3.50	1.6	2.3	0.22	12.7	4.71	5	●	
22 IR4.00ISO-TC	4.00	1.6	2.3	0.25	12.7	4.71	5	●	
22 IR4.50ISO-TC	4.50	1.6	2.4	0.28	12.7	4.71	5	●	
22 IR5.00ISO-TC	5.00	1.6	2.3	0.32	12.7	4.71	5	●	
22 IR5.50ISO-TC	5.50	1.6	2.3	0.36	12.7	4.71	5	●	
22 IR6.00ISO-TC	6.00	1.6	2.4	0.39	12.7	4.71	5	●	
11IR1.50ISO	1.50	0.8	1.0	0.109	6.35	3.00	3.2	●	
16IL1.50ISO	1.50	0.8	1.0	0.11	9.525	3.47	4	●	

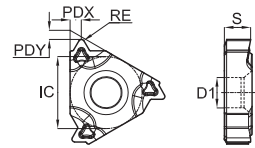

● Stock ○ Available Upon Order

UN 60°  
► External





Ordering Code	Pitch (TPI)	Dimension (mm)							Coated Carbide
		PDY	PDX	RE	IC	S	D1	GM3225	
 16 ER24UN-TC	24	0.8	0.8	0.15	9.525	3.47	4	●	
16 ER20UN-TC	20	0.8	0.9	0.18	9.525	3.47	4	●	
16 ER18UN-TC	18	0.8	1.0	0.20	9.525	3.47	4	●	
16 ER16UN-TC	16	0.9	1.1	0.23	9.525	3.47	4	●	
16 ER14UN-TC	14	1.2	1.5	0.26	9.525	3.47	4	●	
16 ER12UN-TC	12	1.2	1.5	0.31	9.525	3.47	4	●	
16 ER9UN-TC	9	1.2	1.7	0.42	9.525	3.47	4	●	
16 ER8UN-TC	8	1.3	1.7	0.46	9.525	3.47	4	●	
 16ER10UN	10	1.2	1.6	0.41	9.525	3.47	4	●	

● Stock ○ Available Upon Order

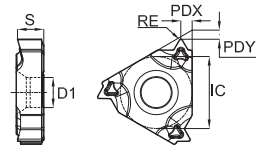
► Internal



Ordering Code	Pitch (TPI)	Dimension (mm)							Coated Carbide
		PDY	PDX	RE	IC	S	D1	GM3225	
 11 IR20UN-TC	20	0.8	0.9	0.09	6.35	3.00	3.2	●	
11 IR18UN-TC	18	0.8	1.0	0.10	6.35	3.00	3.2	●	
16 IR24UN-TC	24	0.8	0.8	0.08	9.525	3.47	4	●	
16 IR20UN-TC	20	0.8	0.9	0.09	9.525	3.47	4	●	
16 IR18UN-TC	18	0.8	1.0	0.10	9.525	3.47	4	●	
16 IR16UN-TC	16	0.9	1.1	0.12	9.525	3.47	4	●	
16 IR14UN-TC	14	1.2	1.5	0.13	9.525	3.47	4	●	
16 IR12UN-TC	12	1.2	1.5	0.16	9.525	3.47	4	●	
16 IR8UN-TC	8	1.3	1.7	0.23	9.525	3.47	4	●	
 16IR10UN	10	1.1	1.5	0.183	9.525	3.47	4	●	

● Stock ○ Available Upon Order

# Whitworth 55°

► External

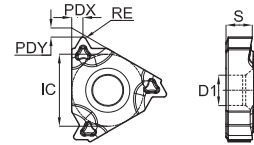

Ordering Code	Pitch (TPI)	Dimension (mm)						Coated Carbide
		PDY	PDX	RE	IC	S	D1	GM3225
16 ER19W-TC	19	0.8	1.0	0.17	9.525	3.47	4	●
16 ER18W-TC	18	0.8	1.0	0.18	9.525	3.47	4	○
16 ER16W-TC	16	0.9	1.1	0.20	9.525	3.47	4	●
16 ER14W-TC	14	1.2	1.5	0.24	9.525	3.47	4	●
16 ER12W-TC	12	1.2	1.5	0.28	9.525	3.47	4	●
16 ER11W-TC	11	1.2	1.5	0.30	9.525	3.47	4	●
16 ER10W-TC	10	1.1	1.5	0.34	9.525	3.47	4	●



● Stock ○ Available Upon Order

► Internal

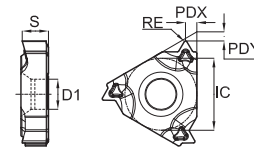

Ordering Code	Pitch (TPI)	Dimension (mm)						Coated Carbide
		PDY	PDX	RE	IC	S	D1	GM3225
11 IR19W-TC	19	0.9	1.1	0.19	6.35	3.00	3.2	●
11 IR14W-TC	14	0.9	1.1	0.27	6.35	3.00	3.2	●
16 IR19W-TC	19	0.8	1.0	0.17	9.525	3.47	4	●
16 IR18W-TC	18	0.8	1.0	0.18	9.525	3.47	4	●
16 IR16W-TC	16	0.9	1.1	0.2	9.525	3.47	4	●
16 IR14W-TC	14	1.2	1.5	0.24	9.525	3.47	4	●
16 IR12W-TC	12	1.2	1.5	0.28	9.525	3.47	4	●
16 IR11W-TC	11	1.2	1.5	0.30	9.525	3.47	4	●
16 IR8W-TC	8	1.2	1.5	0.41	9.525	3.47	4	●





● Stock ○ Available Upon Order

## NPT 60°

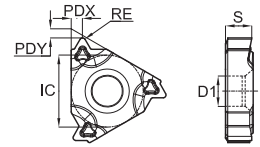
### ► External





Ordering Code	Pitch (TPI)	Dimension (mm)						Coated Carbide	
		PDY	PDX	RE	IC	S	D1	GM3225	
	16 ER27NPT-TC	27	0.7	0.8	0.13	9.525	3.47	4	●
	16 ER18NPT-TC	18	0.8	1.0	0.20	9.525	3.47	4	●
	16 ER14NPT-TC	14	1.2	1.5	0.22	9.525	3.47	4	●
	16 ER11.5NPT-TC	11.5	1.2	1.5	0.25	9.525	3.47	4	●
	16 ER8NPT-TC	8	1.3	1.8	0.30	9.525	3.47	4	●
	16ER11.5NPT	11.5	1.2	1.5	0.091	9.525	3.47	4	●
	16ER14NPT	14	1.2	1.5	0.08	9.525	3.47	4	●
	16ER18NPT	18	0.8	1.0	0.08	9.525	3.47	4	●
	16ER27NPT	27	0.7	0.7	0.08	9.525	3.47	4	●

● Stock ○ Available Upon Order

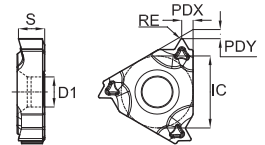
### ► Internal





Ordering Code	Pitch (TPI)	Dimension (mm)						Coated Carbide	
		PDY	PDX	RE	IC	S	D1	GM3225	
	11 IR18NPT-TC	18	0.8	1.0	0.20	6.35	3.00	3.2	●
	16 IR27NPT-TC	27	0.7	0.8	0.13	9.525	3.47	4	○
	16 IR18NPT-TC	18	0.8	1.0	0.20	9.525	3.47	4	●
	16 IR14NPT-TC	14	1.2	1.5	0.22	9.525	3.47	4	●
	16 IR11.5NPT-TC	11.5	1.2	1.5	0.25	9.525	3.47	4	●
	16 IR8NPT-TC	8	1.3	1.8	0.30	9.525	3.47	4	●
	11IR18NPT	18	0.8	1.1	0.081	6.35	3.00	3.2	●
	16IR11.5NPT	11.5	1.2	1.5	0.107	9.525	3.47	4	●
	16IR14NPT	14	1.2	1.5	0.08	9.525	3.47	4	●

● Stock ○ Available Upon Order

# BSPT 55°

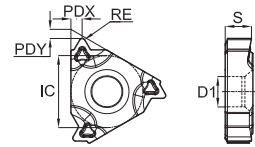
► External





Ordering Code	Pitch (TPI)	Dimension (mm)							Coated Carbide
		PDY	PDX	RE	IC	S	D1	GM3225	
	16 ER28BSPT-TC	28	0.7	0.8	0.11	9.525	3.47	4	●
	16 ER19BSPT-TC	19	0.8	1.0	0.17	9.525	3.47	4	●
	16 ER14BSPT-TC	14	1.2	1.5	0.24	9.525	3.47	4	●
	16 ER11BSPT-TC	11	1.2	1.5	0.30	9.525	3.47	4	●

● Stock ○ Available Upon Order

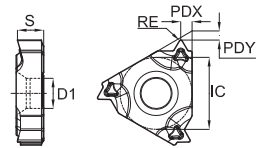
► Internal





Ordering Code	Pitch (TPI)	Dimension (mm)							Coated Carbide
		PDY	PDX	RE	IC	S	D1	GM3225	
	11 IR19BSPT-TC	19	0.8	1.0	0.18	6.35	3.00	3.2	●
	11 IR14BSPT-TC	14	0.9	1.1	0.24	6.35	3.00	3.2	●
	16 IR28BSPT-TC	28	0.7	0.8	0.11	9.525	3.47	4	○
	16 IR19BSPT-TC	19	0.8	1.0	0.17	9.525	3.47	4	●
	16 IR14BSPT-TC	14	1.2	1.5	0.24	9.525	3.47	4	●
	16 IR11BSPT-TC	11	1.2	1.5	0.30	9.525	3.47	4	●
	16 IR11BSPT	11	1.2	1.5	0.32	9.525	3.47	4	●

● Stock ○ Available Upon Order

## Round 30°

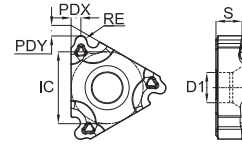
### ► External





Ordering Code	Pitch (TPI)	Dimension (mm)						Coated Carbide		
		PDY	PDX	RE	IC	S	D1	GM3225	GM3215	
	16 ER8RD-TC	8	1.4	1.3	0.75	9.525	3.47	4	●	
	16 ER6RD-TC	6	1.4	1.5	1.00	9.525	3.47	4	●	
	22ER4RD	4	2.2	2.3	1.52	12.7	4.71	5	●	●

● Stock ○ Available Upon Order

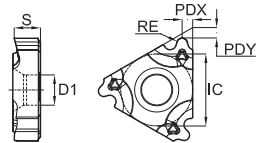
### ► Internal





Ordering Code	Pitch (TPI)	Dimension (mm)						Coated Carbide		
		PDY	PDX	RE	IC	S	D1	GM3225	GM3215	
	16 IR8RD-TC	8	1.4	1.3	0.70	9.525	3.47	4	●	
	16 IR6RD-TC	6	1.4	1.5	0.936	9.525	3.47	4	●	
	22IR4RD	4	2.2	2.3	1.44	12.7	4.71	5	●	●

● Stock ○ Available Upon Order

# TR

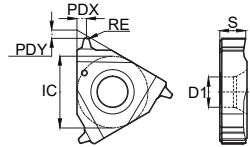
## ► External



Ordering Code	Pitch (mm)	Dimension (mm)							Coated Carbide
		PDY	PDX	RE	IC	S	D1	GM3225	
	16ER1.5TR	1.50	1.0	1.1	0.1	9.525	3.47	4	●
	16ER2.0TR	2.00	1.1	1.3	0.18	9.525	3.47	4	●
	16ER3.0TR	3.00	1.2	1.5	0.11	9.525	3.47	4	●
	22ER4.0TR	4.00	1.7	1.9	0.25	12.7	4.71	5	●
	22ER5.0TR	5.00	1.9	2.1	0.25	12.7	4.71	5	●
	22ER6.0TR	6.00	1.9	2.1	0.25	12.7	4.71	5	●

● Stock ○ Available Upon Order

## ► Internal

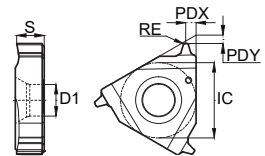

Ordering Code	Pitch (mm)	Dimension (mm)							Coated Carbide
		PDY	PDX	RE	IC	S	D1	GM3225	
	16IR1.5TR	1.50	1.0	1.1	0.1	9.525	3.47	4	●
	16IR2.0TR	2.00	1.0	1.3	0.18	9.525	3.47	4	●
	16IR3.0TR	3.00	1.1	1.3	0.15	9.525	3.47	4	●
	22IR4.0TR	4.00	1.6	1.9	0.25	12.7	4.71	5	●
	22IR5.0TR	5.00	1.84	2.2	0.25	12.7	4.71	5	●
	22IR6.0TR	6.00	1.9	2.2	0.25	12.7	4.71	5	●

● Stock ○ Available Upon Order



# ACME

## ► External

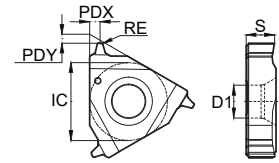

Ordering Code	Pitch (TPI)	Dimension (mm)							Coated Carbide	
		PDY	PDX	RE	IC	S	D1	GM3225	GM3215	
 16ER8ACME	8	1.3	1.5	0.15	9.525	3.47	4	●	○	
16ER10ACME	10	1.1	1	0.1	9.525	3.47	4	●	○	
16ER12ACME	12	1.1	1.3	0.12	9.525	3.47	4	●	●	
22ER5ACME	5	2	2.2	0.12	12.7	4.71	5	●	○	
22ER6ACME	6	1.65	1.75	0.08	12.7	4.71	5	●	○	
27ER4ACME	4	2.4	2.7	0.15	15.875	6.15	6.16	●	○	

● Stock ○ Available Upon Order

## ► Internal

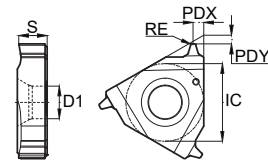



Ordering Code	Pitch (TPI)	Dimension (mm)							Coated Carbide
		PDY	PDX	RE	IC	S	D1	GM3225	
 16IR6ACME	6	1.6	1.8	0.11	9.525	3.47	4	●	
16IR12ACME	12	1.1	1.3	0.08	9.525	3.47	4	●	
22IR5ACME	5	2	2.2	0.12	12.7	4.71	5	●	
22IR6ACME	6	1.65	1.8	0.11	12.7	4.71	5	●	
27IR4ACME	4	2.4	2.7	0.15	15.875	6.15	6.16	●	

● Stock ○ Available Upon Order

## STACME

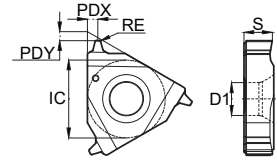
► External





Ordering Code	Pitch (TPI)	Dimension (mm)							Coated Carbide
		PDY	PDX	RE	IC	S	D1	GM3225	
	16ER6STACME	6	1.5	1.5	0.11	9.525	3.47	4	●
	16ER8STACME	8	1.4	1.4	0.1	9.525	3.47	4	●

● Stock ○ Available Upon Order

## STACME

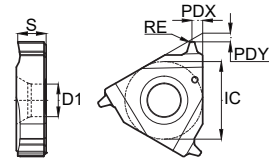
► Internal





Ordering Code	Pitch (TPI)	Dimension (mm)							Coated Carbide
		PDY	PDX	RE	IC	S	D1	GM3225	
	16IR6STACME	6	1.8	1.8	0.12	9.525	3.47	4	●
	16IR8STACME	8	1.2	1.1	0.1	9.525	3.47	4	●
	22IR4STACME	4	2.3	2.4	0.27	12.7	4.71	5	●
	22IR6STACME	6	1.7	1.8	0.12	12.7	4.71	5	●

● Stock ○ Available Upon Order

## SAGE

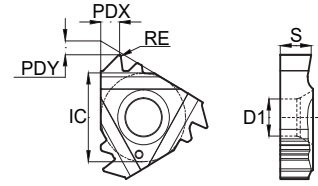
► External





Ordering Code	Pitch (mm)	Dimension (mm)							Coated Carbide
		PDY	PDX	RE	IC	S	D1		
 22ER4.0SAGE	4.00	1.8	2.7	0.46	12.7	4.71	5	GM3225	●

● Stock ○ Available Upon Order

## ABUT

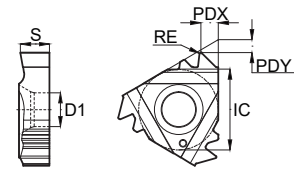
► Internal





Ordering Code	Pitch (TPI)	Dimension (mm)							Coated Carbide
		PDY	PDX	RE	IC	S	D1		
 16IR16ABUT	16	1.3	1.8	0.08	9.525	3.47	4	GM3225	●

● Stock ○ Available Upon Order

## API

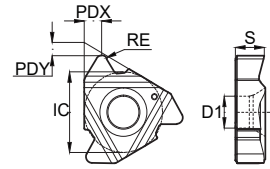
▶ External





Ordering Code	Pitch (TPI)	Dimension (mm)						Coated Carbide	
		PDY	PDX	RE	IC	S	D1	GM3225	GM3215
 22ER4API382 22ER4API502	4	2.1	2.8	0.971	12.7	4.71	5	●	●
	4	1.9	2.8	0.639	12.7	4.71	5	●	○

● Stock ○ Available Upon Order

## API

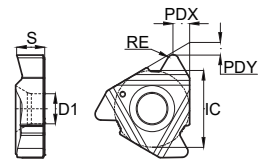
▶ Internal





Ordering Code	Pitch (TPI)	Dimension (mm)						Coated Carbide	
		PDY	PDX	RE	IC	S	D1	GM3225	GM3215
 22IR4API382 22IR4API502	4	2.1	2.8	0.979	12.7	4.71	5	●	●
	4	2.0	2.7	0.644	12.7	4.71	5	●	●

● Stock ○ Available Upon Order

## APIRD

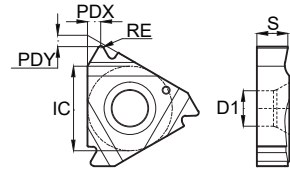
► External





Ordering Code	Pitch (TPI)	Dimension (mm)							Coated Carbide	
		PDY	PDX	RE	IC	S	D1	GM3225	GM3215	
	16ER8APIRD	8	1.3	1.5	0.359	9.525	3.47	4	●	●
	16ER10APIRD	10	1.48	1.5	0.435	9.525	3.47	4	●	○

● Stock ○ Available Upon Order

## APIRD

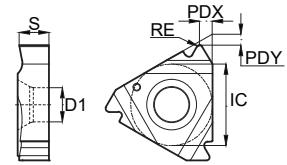
► Internal





Ordering Code	Pitch (TPI)	Dimension (mm)							Coated Carbide
		PDY	PDX	RE	IC	S	D1	GM3225	
	P16IR10APIRD	10	1.5	1.3	0.361	9.525	3.47	4	●
	P16IR8APIRD	8	1.5	1.3	0.438	9.525	3.47	4	●

● Stock ○ Available Upon Order

## MJ

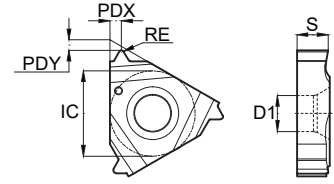
► External





Ordering Code	Pitch (mm)	Dimension (mm)						Coated Carbide	
		PDY	PDX	RE	IC	S	D1		
	16ER1.00MJ	1.00	0.6	0.7	0.165	9.525	3.47	4	●
	16ER1.25MJ	1.25	0.8	0.9	0.207	9.525	3.47	4	●
	16ER1.50MJ	1.50	0.8	1.1	0.24	9.525	3.47	4	●
	16ER2.00MJ	2.00	1	1.3	0.33	9.525	3.47	4	●

● Stock ○ Available Upon Order

## MJ

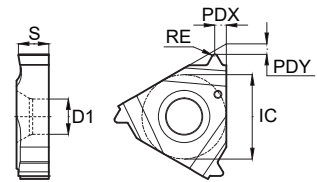
► Internal





Ordering Code	Pitch (mm)	Dimension (mm)						Coated Carbide	
		PDY	PDX	RE	IC	S	D1		
	16IR1.00MJ	1.00	0.6	0.7	0.07	9.525	3.47	4	●

● Stock ○ Available Upon Order

## UNJ

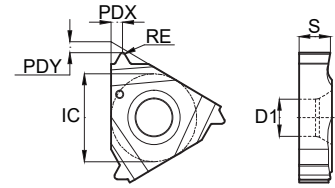
► External





Ordering Code	Pitch (TPI)	Dimension (mm)							Coated Carbide
		PDY	PDX	RE	IC	S	D1		
 16ER18UNJ	18	0.8	1.0	0.23	9.525	3.47	4	●	
16ER28UNJ	28	0.6	0.7	0.15	9.525	3.47	4	●	
16ER32UNJ	32	0.6	0.7	0.13	9.525	3.47	4	●	

● Stock ○ Available Upon Order

## UNJ

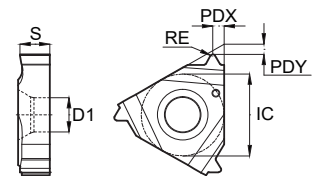
► Internal





Ordering Code	Pitch (TPI)	Dimension (mm)							Coated Carbide
		PDY	PDX	RE	IC	S	D1		
 16IR16UNJ	16	0.8	1.0	0.07	9.525	3.47	4	●	

● Stock ○ Available Upon Order

## Gntp

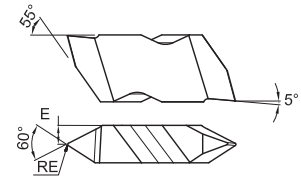
► 60° Partial Profile Threading Inserts With Positive Top Rake



Ordering Code	Pitch				Dimension (mm)		Insert Size	Coated Carbide	
	External (mm)	Internal (mm)	External (TPI)	Internal (TPI)	RE	E		GM3225	
	Gntp2L	0.70-3.00	1.25-3.50	8-36	7-20	0.10	1.91	2	○
	Gntp2R	0.70-3.00	1.25-3.50	8-36	7-20	0.10	1.91	2	○
	Gntp3L	1.25-4.00	2.00-5.00	4-20	5-12	0.17	2.49	3	○
	Gntp3R	1.25-4.00	2.00-5.00	4-20	5-12	0.17	2.49	3	●
	Gntp3004R	1.25-4.00	2.00-5.00	5-36	5-12	0.10	2.49	3	○

● Stock ○ Available Upon Order



# GST

► External

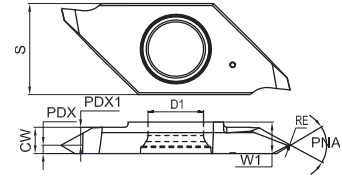

Ordering Code	Pitch		Dimension (mm)									Coated Carbide	
	mm	TPI	W1	CW	S	D1	RE	PDX	PDX1	PNA	GAT7115	GAT7125	
GSTT3LA6000	0.2~0.6	64~48	3	2.5	8.7	5.2	-	2.1	0.4	60°	○	○	
GSTT3LB6000	0.2~0.6	64~48	3	2.5	8.7	5.2	-	0.4	2.1	60°	○	○	
GSTT3LA60005	0.5~1.25	48~24	3	2.5	8.7	5.2	0.05	1.7	0.8	60°	○	○	
GSTT3LB60005	0.5~1.25	48~24	3	2.5	8.7	5.2	0.05	0.8	1.7	60°	○	○	
GSTT3LN6001	1~1.5	24~18	3	2.5	8.7	5.2	0.1	1.25	1.25	60°	○	●	
GSTT3LA55005	-	40~16	3	2.5	8.7	5.2	0.05	1.7	0.8	55°	○	○	
GSTT3LB55005	-	40~16	3	2.5	8.7	5.2	0.05	0.8	1.7	55°	○	○	
GSTT3RA6000	0.2~0.6	64~48	3	2.5	8.7	5.2	-	0.4	2.1	60°	○	●	
GSTT3RB6000	0.2~0.6	64~48	3	2.5	8.7	5.2	-	2.1	0.8	60°	○	○	
GSTT3RA60005	0.5~1.25	48~24	3	2.5	8.7	5.2	0.05	0.8	1.7	60°	○	●	
GSTT3RB60005	0.2~0.6	48~24	3	2.5	8.7	5.2	0.05	1.7	0.8	60°	○	○	
GSTT3RN6001	1~1.5	24~18	3	2.5	8.7	5.2	0.1	1.25	1.25	60°	○	●	
GSTT3RA55005	-	40~16	3	2.5	8.7	5.2	0.05	0.8	1.7	55°	○	○	
GSTT3RB55005	-	40~16	3	2.5	8.7	5.2	0.05	1.7	0.8	55°	○	○	







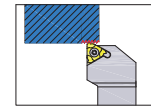
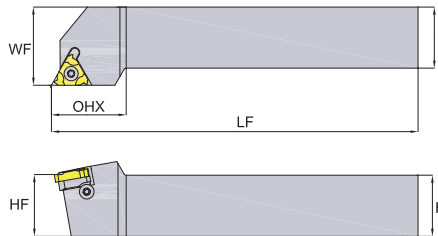

● Stock ○ Available Upon Order

Thread Turning Tool Holders

SER/L Series

External Tool Holders



Ordering Code	Dimension(mm)						Insert	Insert screw 	Shim 	Shim Screw 	Wrench 	Wrench for Shim Screw 	Weight (KG)	Stock	
	H	B	LF	WF	HF	OHX								R	L
SER/L1212F11	12	12	80	14	12	16	11ER/L...	SI60M025080-03510	\	\	TT08PH	\	0.09	<input type="radio"/>	<input type="radio"/>
SER/L1212F16	12	12	80	16	12	21	16ER/L...	SI60M035090-05312	\	\	TT15PH	\	0.09	<input type="radio"/>	<input type="radio"/>
SER/L1616H16	16	16	100	20	16	24	16ER/L...	SI60M035120-05316	DEN16P15SH	SSBM030060H	TT15PH	TH25LH	0.20	<input checked="" type="radio"/>	<input checked="" type="radio"/>
SER/L2020K16	20	20	125	25	20	27	16ER/L...	SI60M035120-05316	DEN16P15SH	SSBM030060H	TT15PH	TH25LH	0.39	<input checked="" type="radio"/>	<input type="radio"/>
SER/L2525M16	25	25	150	32	25	32	16ER/L...	SI60M035120-05316	DEN16P15SH	SSBM030060H	TT15PH	TH25LH	0.74	<input checked="" type="radio"/>	<input checked="" type="radio"/>
SER/L3232P16	32	32	170	40	32	31	16ER/L...	SI60M035120-05316	DEN16P15SH	SSBM030060H	TT15PH	TH25LH	1.37	<input checked="" type="radio"/>	<input type="radio"/>
SER/L2525M22	25	25	150	32	25	31	22ER/L...	SI60M040160-07013	DEN22P15SH	SSBM040060H	TT20PH	TH30LH	0.74	<input checked="" type="radio"/>	<input type="radio"/>
SER/L3232P22	32	32	170	40	32	32	22ER/L...	SI60M040160-07013	DEN22P15SH	SSBM040060H	TT20PH	TH30LH	1.37	<input checked="" type="radio"/>	<input type="radio"/>
SER/L4040R22	40	40	200	50	40	32	22ER/L...	SI60M040160-07013	DEN22P15SH	SSBM040060H	TT20PH	TH30LH	2.51	<input type="radio"/>	<input type="radio"/>
SER/L3232P27	32	32	170	40	32	33	27ER/L...	SI60M050160-07212	DEN27P15SH	SSBM040060H	TT20PH	TH30LH	1.37	<input checked="" type="radio"/>	<input checked="" type="radio"/>
SER/L4040R27	40	40	200	50	40	33	27ER/L...	SI60M050160-07212	DEN27P15SH	SSBM040060H	TT20PH	TH30LH	2.51	<input type="radio"/>	<input checked="" type="radio"/>

Remark: SI60M035120-05316 is meaning of M3.5X12

●Stock ○Available Upon Order

Thread Turning Tool Holders

SIR/L Series

Internal Tool Holders

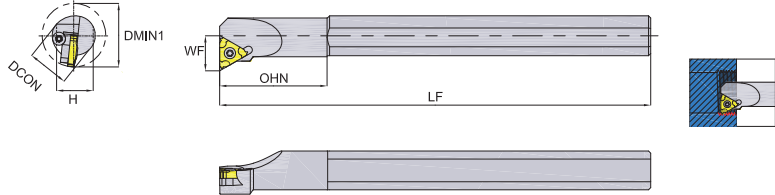

Ordering Code	Dimension(mm)						Insert	Insert screw	Shim	Shim Screw	Wrench	Wrench for Shim Screw	Weight (KG)	Stock	
	DMIN1	DCON	H	LF	WF	OHN								R	L
SIR/L0008K08	9.9	8	7.4	125	4.95	20	08IR/L...	SI60M022050-03008	\	\	TT06PH	\	0.05	●	●
SIR/L0010K11	13	10	9	125	6.5	25	11IR/L...	SI60M025060-03510	\	\	TT08PH	\	0.08	●	●
SIR/L0010K11-A16	13	16	15	125	6.5	30	11IR/L...	SI60M025060-03510	\	\	TT08PH	\	0.20	●	○
SIR/L0012K11	15	12	11	125	7.4	28	11IR/L...	SI60M025060-03510	\	\	TT08PH	\	0.11	●	○
SIR/L0012K11-A16	15	16	15	125	7.4	36	11IR/L...	SI60M025060-03510	\	\	TT08PH	\	0.20	○	○
SIR/L0013M16	19	16	15	150	9.4	32	16IR/L...	SI60M035090-05312	\	\	TT15PH	\	0.24	●	○
SIR/L0016Q16	21	16	15	180	10.8	40	16IR/L...	SI60M035090-05312	\	\	TT15PH	\	0.28	●	●
SIR/L0020Q16	24	20	18	180	13.1	40	16IR/L...	SI60M035120-05316	DIN16P15SH	SSBM030060H	TT15PH	TH25LH	0.44	●	○
SIR/L0025R16	29	25	23	200	15.6	45	16IR/L...	SI60M035120-05316	DIN16P15SH	SSBM030060H	TT15PH	TH25LH	0.77	●	○
SIR/L0032S16	38	32	30	250	19.1	50	16IR/L...	SI60M035120-05316	DIN16P15SH	SSBM030060H	TT15PH	TH25LH	1.58	●	○
SIR/L0040T16	44	40	38	300	23.1	55	16IR/L...	SI60M035120-05316	DIN16P15SH	SSBM030060H	TT15PH	TH25LH	2.96	○	○
SIR/L0050U16	60	50	48	350	28.1	50	16IR/L...	SI60M035120-05316	DIN16P15SH	SSBM030060H	TT15PH	TH25LH	5.39	○	○
SIR/L0020Q22	26	20	18	180	13.2	40	22IR/L...	SI60M040120-07010	\	\	TT20PH	\	0.44	●	●
SIR/L0025R22	32	25	23	200	16.4	46	22IR/L...	SI60M040160-07013	DIN22P15SH	SSBM040060H	TT20PH	TH30LH	0.77	●	●
SIR/L0032S22	39	32	30	250	19.9	50	22IR/L...	SI60M040160-07013	DIN22P15SH	SSBM040060H	TT20PH	TH30LH	1.58	●	○
SIR/L0040T22	47	40	38	300	23.9	55	22IR/L...	SI60M040160-07013	DIN22P15SH	SSBM040060H	TT20PH	TH30LH	2.96	○	○
SIR/L0050U22	57	50	48	350	28.9	70	22IR/L...	SI60M040160-07013	DIN22P15SH	SSBM040060H	TT20PH	TH30LH	5.39	○	○
SIR/L0032S27	42	32	30	250	20.9	50	27IR/L...	SI60M050160-07212	DIN27P15SH	SSBM040060H	TT20PH	TH30LH	1.58	○	○
SIR/L0040T27	50	40	38	300	25	55	27IR/L...	SI60M050160-07212	DIN27P15SH	SSBM040060H	TT20PH	TH30LH	2.96	○	○
SIR/L0050U27	60	50	48	350	30.1	70	27IR/L...	SI60M050160-07212	DIN27P15SH	SSBM040060H	TT20PH	TH30LH	5.39	○	○

Remark: SI60M035120-05316 is meaning of M3.5X12

● Stock ○ Available Upon Order

External Tool Holders

G-Notch Series

# GNS

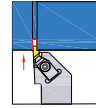
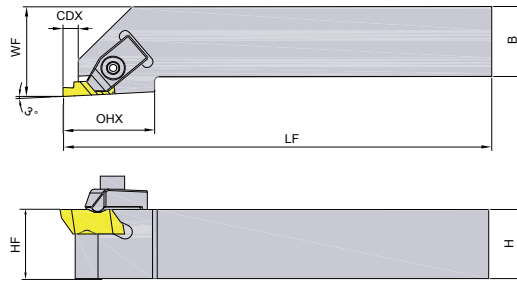

The picture is Right Hand Holder

Ordering Code	Dimension (mm)						Insert	Screws	Press Plate	Wrench	Weight (KG)	Stock	
	H	B	WF	LF	OHX	CDX						R	L
GNSR/L1616H2	16	16	20	100	19	3.5	GN.2	SCAM040120H	CAN02RH	TH30LH	0.20	●	○
GNSR/L2020K2	20	20	25	125	19	3.5	GN.2	SCAM040120H	CAN02RH	TH30LH	0.38	○	○
GNSR/L2525M2	25	25	32	150	19	3.5	GN.2	SCAM040120H	CAN02RH	TH30LH	0.74	○	○
GNSR/L2020K3	20	20	25	125	32	5.3	GN.3	SCAM050200H	CAN03RH	TH40LH	0.39	●	○
GNSR/L2525M3	25	25	32	150	32	5.3	GN.3	SCAM050200H	CAN03RH	TH40LH	0.74	●	●

Note: Tool holder for threading inserts and grooving inserts

● Stock ○ Available Upon Order

Internal Tool holders

G-Notch Series

# GNA

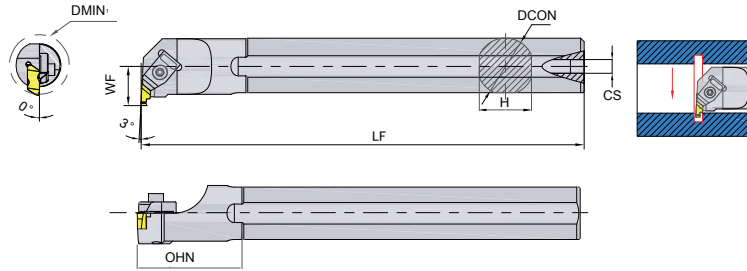

The picture is Right Hand Holder

Ordering Code	Dimension (mm)					Insert	Screws	Press Plate	Wrench	Weight (KG)	Stock	
	DCON	DMIN1	LF	WF	CS						R	L
GNAR/L20Q2	20	26	180	13	1/8-27 NPT	GN.2	SCAM040120H	CAN02LH	TH30LH	0.44	<input type="radio"/>	<input checked="" type="radio"/>
GNAR/L25R2	25	34	200	17	1/4-18 NPT	GN.2	SCAM040120H	CAN02LH	TH30LH	0.77	<input type="radio"/>	<input type="radio"/>
GNAR/L25R3	25	34	200	17	1/4-18 NPT	GN.3	SCAM050200H	CAN03LH	TH40LH	0.77	<input type="radio"/>	<input type="radio"/>



Note: Left hand bars use right hand inserts, Right hand bars use left hand inserts

● Stock ○ Available Upon Order

## Small Parts Tool Holder

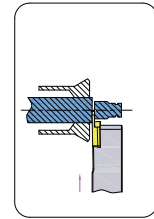
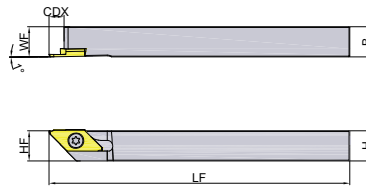
## GST Series

**GST**

Ordering Code	Dimension (mm)						Inserts	Screws 	Wrench 	Weight (KG)	Stock	
	H	B	LF	HF	WF	CDX					R	L
GSTR/L1010JK3	10	10	120	10	10	6	GST*3R/L**	SSAM045095Q	TT10PQ	0.09	●	○
GSTR/L1010JK4	10	10	120	10	10	8	GST*4R/L**	SSAM045095Q	TT10PQ	0.09	●	○
GSTR/L1212JK3	12	12	120	12	12	6	GST*3R/L**	SSAM045095Q	TT10PQ	0.14	●	○
GSTR/L1212JK4	12	12	120	12	12	8	GST*4R/L**	SSAM045095Q	TT10PQ	0.14	●	○
GSTR/L1616JK3	16	16	120	16	16	6	GST*3R/L**	SSAM045095Q	TT10PQ	0.24	●	○
GSTR/L1616JK4	16	16	120	16	16	8	GST*4R/L**	SSAM045095Q	TT10PQ	0.24	●	○
GSTR/L2020JK3	20	20	120	20	20	6	GST*3R/L**	SSAM045095Q	TT10PQ	0.40	●	○
GSTR/L2020JK4	20	20	120	20	20	8	GST*4R/L**	SSAM045095Q	TT10PQ	0.40	●	○



● Stock ○ Available Upon Order

Small Parts Tool Holder

GST Series

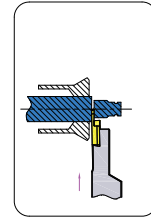
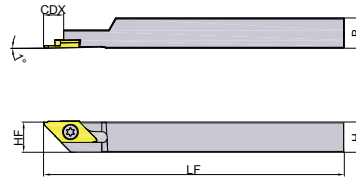
# GST-RS



Ordering Code	Dimension (mm)						Inserts	Screws 	Wrench 	Weight (KG)	Stock	
	H	B	LF	HF	WF	CDX					R	L
GSTR/L1010JK3-RS	10	10	120	10	7.2	6	GST*3R/L**	SSAM045070Q	TT10PQ	0.09	●	○
GSTR/L1212JK3-RS	12	12	120	12	7.2	6	GST*3R/L**	SSAM045070Q	TT10PQ	0.14	●	○
GSTR/L1010JK4-RS	10	10	120	10	7.2	8	GST*4R/L**	SSAM045070Q	TT10PQ	0.09	●	○
GSTR/L1212JK4-RS	12	12	120	12	7.2	8	GST*4R/L**	SSAM045070Q	TT10PQ	0.14	●	○

● Stock ○ Available Upon Order

## Cutting Passes and Radial Infeed Recommendation Table

### ► ISO Metric / External

Pitch (mm)	1.00	1.25	1.50	1.75	2.00	2.50	3.00	3.50	4.00	4.50	5.00	5.50	6.00
Total infeed (mm)	0.65	0.79	0.95	1.11	1.26	1.56	1.88	2.18	2.49	2.79	3.10	3.39	3.70
Total passes	5	6	6	8	8	10	12	12	14	14	14	16	16
No. of infeed	Radial infeed per pass (mm)												
1	0.16	0.17	0.20	0.17	0.20	0.20	0.20	0.24	0.24	0.27	0.29	0.27	0.30
2	0.15	0.15	0.19	0.17	0.19	0.19	0.19	0.23	0.22	0.25	0.28	0.26	0.29
3	0.14	0.14	0.18	0.16	0.18	0.18	0.19	0.22	0.22	0.24	0.27	0.26	0.29
4	0.12	0.13	0.16	0.15	0.17	0.17	0.18	0.21	0.21	0.23	0.26	0.25	0.28
5	0.08	0.12	0.14	0.14	0.16	0.17	0.17	0.21	0.21	0.23	0.25	0.25	0.27
6		0.08	0.08	0.13	0.15	0.16	0.17	0.20	0.20	0.22	0.25	0.24	0.26
7				0.11	0.13	0.15	0.16	0.18	0.19	0.21	0.24	0.23	0.26
8				0.08	0.08	0.14	0.15	0.17	0.18	0.20	0.23	0.23	0.25
9						0.12	0.14	0.16	0.17	0.19	0.22	0.22	0.24
10						0.08	0.13	0.15	0.16	0.18	0.20	0.21	0.23
11							0.12	0.13	0.15	0.17	0.19	0.20	0.22
12							0.08	0.08	0.14	0.16	0.17	0.19	0.20
13									0.12	0.14	0.15	0.18	0.19
14									0.18	0.10	0.10	0.16	0.17
15												0.14	0.15
16												0.10	0.10

### ► ISO Metric / Internal

Pitch (mm)	1.00	1.25	1.50	1.75	2.00	2.50	3.00	3.50	4.00	4.50	5.00	5.50	6.00
Total infeed (mm)	0.63	0.77	0.92	1.05	1.20	1.48	1.78	2.03	2.31	2.61	2.88	3.19	3.44
Total passes	5	6	6	8	8	10	12	12	13	14	14	16	16
No. of infeed	Radial infeed per pass (mm)												
1	0.15	0.16	0.20	0.16	0.19	0.19	0.19	0.22	0.21	0.23	0.26	0.25	0.28
2	0.14	0.15	0.18	0.15	0.18	0.18	0.18	0.21	0.21	0.23	0.26	0.25	0.27
3	0.13	0.14	0.17	0.15	0.17	0.17	0.18	0.20	0.20	0.22	0.25	0.24	0.26
4	0.12	0.13	0.15	0.14	0.16	0.17	0.17	0.20	0.19	0.22	0.24	0.24	0.26
5	0.08	0.11	0.13	0.13	0.15	0.16	0.16	0.19	0.19	0.21	0.24	0.23	0.26
6		0.08	0.08	0.12	0.14	0.15	0.16	0.18	0.18	0.20	0.23	0.22	0.24
7				0.11	0.12	0.14	0.15	0.17	0.18	0.20	0.22	0.22	0.24
8				0.08	0.08	0.13	0.14	0.16	0.17	0.19	0.21	0.22	0.23
9						0.12	0.14	0.15	0.16	0.18	0.20	0.20	0.22
10						0.08	0.12	0.14	0.15	0.17	0.19	0.20	0.21
11							0.11	0.12	0.14	0.16	0.18	0.19	0.20
12							0.08	0.08	0.13	0.15	0.16	0.18	0.19
13									0.12	0.14	0.15	0.17	0.18
14									0.08	0.10	0.10	0.16	0.16
15												0.14	0.15
16												0.10	0.10



## ► UN / External

Pitch (TPI)	24	20	18	16	14	12	10	8
Total infeed (mm)	0.70	0.84	0.92	1.04	1.17	1.35	1.62	2.02
Total passes	5	6	6	7	8	8	10	12
No. of infeed	Radial infeed per pass (mm)							
1	0.18	0.18	0.20	0.19	0.18	0.22	0.21	0.22
2	0.16	0.17	0.18	0.18	0.18	0.21	0.20	0.21
3	0.15	0.15	0.17	0.17	0.17	0.20	0.19	0.20
4	0.13	0.14	0.15	0.16	0.16	0.19	0.18	0.20
5	0.08	0.12	0.13	0.14	0.15	0.17	0.17	0.19
6		0.08	0.08	0.12	0.14	0.15	0.16	0.18
7				0.08	0.12	0.13	0.15	0.17
8					0.08	0.08	0.14	0.16
9							0.12	0.15
10							0.08	0.14
11								0.12
12								0.08

## ► UN / Internal

Pitch (TPI)	24	20	18	16	14	12	10	8
Total infeed (mm)	0.66	0.78	0.86	0.96	1.07	1.25	1.48	2.03
Total passes	5	6	6	7	8	8	10	12
No. of infeed	Radial infeed per pass (mm)							
1	0.16	0.16	0.18	0.17	0.16	0.20	0.19	0.22
2	0.15	0.16	0.17	0.16	0.16	0.19	0.18	0.21
3	0.14	0.14	0.16	0.15	0.15	0.18	0.17	0.20
4	0.12	0.13	0.14	0.14	0.14	0.17	0.17	0.20
5	0.08	0.12	0.13	0.13	0.14	0.16	0.16	0.19
6		0.08	0.08	0.12	0.13	0.14	0.15	0.18
7				0.08	0.11	0.13	0.14	0.17
8					0.08	0.08	0.13	0.16
9							0.12	0.15
10							0.08	0.14
11								0.12
12								0.08

## ► Whitworth / External&amp; Internal

Pitch (TPI)	19	18	16	14	12	11	10	8
Total infeed (mm)	0.90	0.97	1.08	1.20	1.42	1.51	1.70	2.10
Total passes	6	7	8	8	8	9	10	12
No. of infeed	Radial infeed per pass (mm)							
1	0.19	0.17	0.17	0.19	0.23	0.22	0.22	0.23
2	0.18	0.16	0.16	0.18	0.22	0.21	0.21	0.22
3	0.17	0.16	0.15	0.17	0.21	0.20	0.20	0.21
4	0.15	0.15	0.15	0.16	0.19	0.19	0.19	0.21
5	0.13	0.13	0.14	0.15	0.18	0.18	0.18	0.20
6	0.08	0.12	0.13	0.14	0.16	0.16	0.17	0.19
7		0.08	0.11	0.12	0.14	0.15	0.16	0.18
8			0.08	0.08	0.08	0.13	0.15	0.17
9						0.08	0.13	0.16
10							0.08	0.14
11								0.12
12								0.08

## ► NPT / External&amp; Internal

Pitch (TPI)	27	18	14	11.5	8
Total infeed (mm)	0.76	1.11	1.42	1.73	2.48
Total passes	6	8	10	12	15
No. of infeed	Radial infeed per pass (mm)				
1	0.15	0.17	0.18	0.18	0.21
2	0.15	0.17	0.17	0.17	0.21
3	0.14	0.16	0.16	0.17	0.20
4	0.13	0.15	0.16	0.16	0.20
5	0.11	0.14	0.15	0.16	0.19
6	0.08	0.13	0.14	0.15	0.18
7		0.11	0.14	0.15	0.18
8		0.08	0.13	0.14	0.17
9			0.11	0.13	0.17
10			0.08	0.12	0.16
11				0.11	0.15
12				0.08	0.14
13					0.13
14					0.11
15					0.08

## ► BSPT / External&amp; Internal

Pitch (TPI)	28	19	14	11
Total infeed (mm)	0.62	0.90	1.20	1.51
Total passes	5	6	8	9
No. of infeed	Radial infeed per pass (mm)			
1	0.15	0.19	0.19	0.22
2	0.14	0.18	0.18	0.21
3	0.13	0.17	0.17	0.20
4	0.12	0.15	0.16	0.19
5	0.08	0.13	0.15	0.18
6		0.08	0.14	0.16
7			0.12	0.15
8			0.08	0.13
9				0.08

## ► Round / External

Pitch (TPI)	10	8	6	4
Total infeed (mm)	1.30	1.63	2.17	2.95
Total passes	8	10	12	14
No. of infeed	Radial infeed per pass (mm)			
1	0.21	0.21	0.24	0.30
2	0.20	0.20	0.23	0.29
3	0.19	0.19	0.22	0.28
4	0.18	0.19	0.21	0.27
5	0.16	0.18	0.20	0.26
6	0.15	0.17	0.19	0.25
7	0.13	0.15	0.18	0.24
8	0.08	0.14	0.17	0.23
9		0.12	0.16	0.22
10		0.08	0.15	0.21
11			0.13	0.19
12			0.08	0.18
13				0.15
14				0.10

## ► Round/ Internal

Pitch (TPI)	10	8	6	4
Total infeed (mm)	1.34	1.64	2.18	2.98
Total passes	8	10	12	14
No. of infeed	Radial infeed per pass (mm)			
1	0.22	0.21	0.24	0.30
2	0.21	0.20	0.23	0.29
3	0.20	0.20	0.22	0.29
4	0.18	0.19	0.21	0.28
5	0.17	0.18	0.21	0.27
6	0.15	0.17	0.20	0.26
7	0.13	0.16	0.19	0.25
8	0.08	0.14	0.17	0.24
9		0.12	0.16	0.23
10		0.08	0.15	0.21
11			0.13	0.20
12			0.08	0.18
13				0.16
14				0.10

Attention: Infeeds of less than 0.05mm should be avoided, for austenitic stainless steels not less than 0.08mm.

► TR/ External& Internal

Pitch (mm)	1.5	2	3	1.75	2.00	2.50	3.00	3.50
Total infeed (mm)	1.02	1.36	1.27	1.11	1.26	1.56	1.88	2.18
Total passes	6	8	12	13	14	16	16	19
No. of infeed	Radial infeed per pass (mm)							
1	0.22	0.22	0.20	0.24	0.27	0.29	0.34	0.32
2	0.21	0.21	0.19	0.23	0.27	0.29	0.33	0.31
3	0.19	0.20	0.18	0.22	0.26	0.28	0.32	0.31
4	0.17	0.19	0.18	0.22	0.25	0.27	0.32	0.30
5	0.14	0.17	0.17	0.21	0.24	0.27	0.31	0.29
6	0.08	0.16	0.17	0.20	0.23	0.26	0.30	0.29
7		0.13	0.16	0.19	0.22	0.25	0.29	0.28
8		0.08	0.15	0.18	0.21	0.24	0.28	0.27
9			0.14	0.17	0.20	0.23	0.26	0.26
10			0.13	0.16	0.19	0.22	0.25	0.25
11			0.11	0.14	0.17	0.21	0.24	0.25
12			0.08	0.13	0.16	0.20	0.22	0.24
13				0.08	0.13	0.19	0.21	0.23
14					0.08	0.17	0.19	0.22
15						0.15	0.16	0.20
16						0.10	0.10	0.19
17								0.17
18								0.15
19								0.10

## ► ACME / External

Pitch (TPI)	16	14	12	10	8	6	5	4	3
Total infeed (mm)	0.99	1.10	1.26	1.60	1.91	2.46	2.87	3.51	4.57
Total passes	6	7	8	10	12	13	14	16	19
No. of infeed	Radial infeed per pass (mm)								
1	0.22	0.20	0.20	0.20	0.20	0.24	0.26	0.28	0.31
2	0.20	0.19	0.19	0.20	0.20	0.23	0.25	0.28	0.31
3	0.19	0.18	0.18	0.19	0.19	0.23	0.25	0.27	0.30
4	0.17	0.17	0.17	0.18	0.18	0.22	0.24	0.26	0.30
5	0.14	0.15	0.16	0.17	0.18	0.21	0.23	0.26	0.29
6	0.08	0.13	0.15	0.16	0.17	0.20	0.23	0.25	0.28
7		0.08	0.13	0.15	0.16	0.20	0.22	0.24	0.28
8			0.08	0.14	0.15	0.19	0.21	0.23	0.27
9				0.12	0.14	0.18	0.20	0.22	0.26
10				0.08	0.13	0.17	0.19	0.22	0.25
11					0.12	0.16	0.18	0.21	0.24
12					0.08	0.14	0.16	0.19	0.23
13						0.10	0.14	0.18	0.22
14							0.10	0.17	0.21
15								0.15	0.20
16								0.10	0.19
17									0.17
18									0.15
19									0.1

► ACME / Internal

Pitch (TPI)	16	14	12	10	8	6	5	4	3
Total infeed (mm)	1.02	1.14	1.30	1.64	1.95	2.48	2.90	3.54	4.56
Total passes	6	7	8	10	12	13	14	16	19
No. of infeed	Radial infeed per pass (mm)								
1	0.22	0.21	0.21	0.21	0.21	0.24	0.26	0.29	0.31
2	0.21	0.20	0.20	0.20	0.20	0.23	0.26	0.28	0.31
3	0.19	0.19	0.19	0.20	0.20	0.23	0.25	0.27	0.30
4	0.17	0.17	0.18	0.19	0.19	0.22	0.24	0.27	0.29
5	0.14	0.16	0.16	0.18	0.18	0.21	0.24	0.26	0.29
6	0.08	0.13	0.15	0.17	0.17	0.21	0.23	0.25	0.28
7		0.08	0.13	0.16	0.17	0.20	0.22	0.24	0.27
8			0.08	0.14	0.16	0.19	0.21	0.23	0.27
9				0.12	0.15	0.18	0.20	0.23	0.26
10				0.08	0.13	0.17	0.19	0.22	0.25
11					0.12	0.16	0.18	0.21	0.24
12					0.08	0.14	0.16	0.20	0.23
13						0.10	0.15	0.18	0.22
14							0.10	0.17	0.21
15								0.15	0.20
16								0.10	0.19
17									0.17
18									0.15
19									0.1

## ► STACME / External&amp; Internal

Pitch (TPI)	16	14	12	19	8	6	5	4	3
Total infeed (mm)	0.70	0.77	0.87	1.13	1.33	1.64	1.90	2.27	2.90
Total passes	5	5	6	7	8	9	10	11	15
No. of infeed	Radial infeed per pass (mm)								
1	0.18	0.20	0.18	0.21	0.22	0.24	0.25	0.24	0.25
2	0.16	0.18	0.17	0.20	0.21	0.23	0.24	0.24	0.24
3	0.15	0.17	0.16	0.19	0.19	0.22	0.23	0.23	0.24
4	0.13	0.14	0.15	0.17	0.18	0.21	0.22	0.22	0.23
5	0.08	0.08	0.13	0.15	0.17	0.19	0.21	0.21	0.22
6			0.08	0.13	0.15	0.18	0.19	0.20	0.22
7				0.08	0.13	0.16	0.18	0.19	0.21
8					0.08	0.14	0.16	0.18	0.20
9						0.08	0.14	0.17	0.19
10							0.09	0.16	0.18
11								0.14	0.17
12								0.09	0.16
13									0.15
14									0.13
15									0.09

## ► API / External&amp; Internal

Pitch (TPI)	4	5
Total infeed (mm)	3.08	3.74
Total passes	12	15
No. of infeed	Radial infeed per pass (mm)	
1	0.36	0.34
2	0.35	0.34
3	0.33	0.33
4	0.32	0.31
5	0.30	0.30
6	0.29	0.29
7	0.27	0.28
8	0.25	0.27
9	0.23	0.25
10	0.20	0.24
11	0.16	0.22
12	0.08	0.20
13		0.18
14		0.15
15		0.08



## ► APIRD / External&amp; Internal

Pitch (TPI)	8	10
Total infeed (mm)	1.80	1.40
Total passes	10	12
No. of infeed	Radial infeed per pass (mm)	
1	0.18	0.19
2	0.18	0.19
3	0.17	0.18
4	0.16	0.18
5	0.16	0.17
6	0.15	0.16
7	0.14	0.16
8	0.13	0.15
9	0.11	0.14
10	0.08	0.13
11		0.11
12		0.08

## ► MJ / External

Pitch (mm)	1.5	2
Total infeed (mm)	0.92	1.21
Total passes	6	8
No. of infeed	Radial infeed per pass (mm)	
1	0.2	0.19
2	0.18	0.18
3	0.17	0.17
4	0.15	0.16
5	0.13	0.15
6	0.08	0.14
7		0.12
8		0.08

## ► UNJ / Internal

Pitch (TPI)	32	28	24	20	18	16	14	12	10	8
Total infeed (mm)	0.51	0.57	0.66	0.78	0.87	0.97	1.10	1.27	1.52	1.90
Total passes	4	5	5	6	6	7	8	8	10	12
No. of infeed	Radial infeed per pass (mm)									
1	0.16	0.14	0.16	0.16	0.18	0.17	0.17	0.20	0.19	0.20
2	0.14	0.13	0.15	0.15	0.17	0.16	0.16	0.19	0.19	0.20
3	0.13	0.12	0.14	0.14	0.16	0.16	0.16	0.18	0.18	0.19
4	0.08	0.11	0.12	0.13	0.15	0.15	0.15	0.17	0.17	0.18
5		0.08	0.08	0.12	0.13	0.13	0.14	0.16	0.16	0.18
6				0.08	0.08	0.12	0.13	0.15	0.15	0.17
7						0.08	0.11	0.13	0.14	0.16
8							0.08	0.08	0.13	0.15
9									0.12	0.14
10									0.08	0.13
11										0.12
12										0.08

## Cutting Speed Recommendation Table

ISO	Workpiece Material		Material Hardness	Grade	Cutting Speed Vc (m/min)	
<b>P</b>	Carbon Steel	Low-carbon (C=0.1-0.25%)	HB125	GM3225	120-160-230	
		Medium-carbon (C=0.25-0.55%)	HB150		100-150-195	
		High-carbon (C=0.55-0.80%)	HB170		90-140-180	
	Low-alloy Steel	Non-hardened	HB180		100-130-180	
		Hardened and tempered	HB275		75-100-140	
		Hardened and tempered	HB350		60-80-130	
	High-alloy Steel	Annealed	HB200		80-110-140	
		Hardened and tempered	HB325		70-90-115	
	Steel Castings	Unalloyed	HB180		180-200-220	
		Low-alloy	HB200		70-110-150	
		High-alloy	HB225		60-100-120	
		Manganese steel (12-14% Mn)	HB250		30-40-50	
<b>M</b>	Stainless Steel	Austenitic	HB180	GM3225	90-120-140	
		Ferritic/Martensitic	HB200		70-140-170	
		Duplex stainless steel	HB230		60-90-120	
<b>K</b>	Malleable Cast Iron	Ferritic	HB130	GM3225	110-130-170	
		Pearlitic	HB230		85-100-145	
	Gray Cast Iron	Low tensile strength	HB180		100-120-160	
		High tensile strength	HB260		80-100-140	
	Nodular Cast Iron	Ferritic	HB160		110-125-160	
		Ferritic	HB250		80-100-120	
<b>N</b>	Wrought Aluminum Alloys	Non aging	HB60	GM3225	350-500-700	
		Aged	HB100		300-400-500	
	Cast Aluminum Alloys	Non aging	HB75		300-450-500	
		Aged	HB90		200-290-400	
		Containing silicon (13-22% Si)	HB130		100-200-300	
	Copper and Copper Alloys	Brass	HB90		100-220-300	
		Bronze and non-lead copper	HB100		80-180-255	
<b>S</b>	Heat-resistant Alloys	Iron base	Annealed	GM3225	35-45-60	
			Aged		HB280	25-35-50
		Nickel base and cobalt base	Annealed		HB250	15-25-30
			Aged		HB350	10-15-25
			Cast		HB320	10-13-20
	Titanium Alloys	Commercial pure (99.5% Ti)	400Rm	140-150-170		
α+β alloys		1050Rm	50-60-70			
<b>H</b>	High Hardness Materials	Hardened steel	HRC55	GM3225	40-45-50	
		Chilled cast iron	HB400		30-40-50	

## GST Series Threading Insert Recommended Cutting Datas

### Cutting Passes and Radial Infeed Recommendation Table

Thread type	Pitch	Ordering Code	Corner radius (RE)	Cutting depth (mm)	Total passes	1	2	3	4	5	6	7	8	9	10			
	mm																	
ISO Metric	External	GSTT 3R/L A/B6000	Max 0.05 Flat	0.15	4	0.06	0.04	0.03	0.02									
				0.19	4	0.07	0.06	0.04	0.02									
				0.23	4	0.08	0.07	0.06	0.02									
				0.27	5	0.08	0.07	0.06	0.04	0.02								
				0.30	5	0.10	0.08	0.06	0.04	0.02								
				0.34	6	0.10	0.08	0.06	0.04	0.04	0.02							
	0.50	GSTT 3R/L A/B6000	Max 0.05 Flat	0.38	6	0.10	0.10	0.07	0.05	0.04	0.02							
		GSTT 3R/L A/B60005	0.05	0.33	5	0.10	0.10	0.07	0.04	0.02								
	0.60	GSTT 3R/L A/B6000	Max 0.05 Flat	0.45	7	0.10	0.10	0.08	0.06	0.05	0.04	0.02						
		GSTT 3R/L A/B60005	0.05	0.40	6	0.10	0.10	0.08	0.06	0.04	0.02							
	0.70		0.05	0.48	6	0.10	0.10	0.10	0.10	0.06	0.02							
	0.75	GSTT 3R/L A/B60005	0.05	0.52	7	0.10	0.10	0.10	0.08	0.07	0.05	0.02						
			0.05	0.56	7	0.10	0.10	0.10	0.10	0.08	0.06	0.02						
	1.00	GSTT 3R/L A/B60005 GSTT 3R/L N6001	0.05	0.71	8	0.15	0.15	0.12	0.10	0.08	0.06	0.03	0.02					
			0.05	0.66	7	0.18	0.15	0.12	0.10	0.06	0.03	0.02						
	1.25	GSTT 3R/L A/B60005 GSTT 3R/L N6001	0.10	0.90	9	0.20	0.18	0.13	0.10	0.10	0.07	0.05	0.05	0.02				
			0.05	0.85	8	0.20	0.18	0.13	0.10	0.10	0.07	0.05	0.02					
	1.50	GSTT 3R/L N6001	0.10	1.04	10	0.20	0.18	0.14	0.12	0.10	0.10	0.08	0.05	0.05	0.02			

### Recommended Cutting Speed

ISO	Workpiece Material	Hardness (HB)	Grade	Cutting Speed Vc(m/min)
<b>P</b>	Steel	≤300	GAT7115	120(60-180)
			GAT7125	90(40-150)
<b>M</b>	Stainless steel	≤300	GAT7115	100(60-150)
			GAT7125	80(40-130)

H



# APPENDIX



## Chip Breaker Comparison Table

ISO	Tool Type	Application	GESAC	Sandvik	Seco	Iscar	KennaMetal	Walter	Mitsubishi	Sumitomo	Tungaloy	Kyocera	Taegutec	Korloy	
<b>P</b>	Negative	Finishing	GF QF TF SPL	PF QF LC	FF1 FF2 MF2	NF F3P	FP FN	FP5	LP SA SY SH	LU SU SE	TS TSF ZF	PP HQ CQ XQ	FA FG	VL VF VB	
		Semi-finishing (L&R)	TS SV	K						UM HM	P S	25R	VF		
		Semi-finishing	GM QM TP	PM QM	M3 MF5	TF GN M3P	MP MN	MP3 MP5	MA MP	GU GE UX	TM DM AM	PQ PG PS GS PT	MC MP PC MT	VM LP MP GM	
		Semi-finishing with Wiper	WMV	WMX WM	W-M3	WG	MW	NM	MW	GUW	SW ASW	WE WQ	WT	LW	
		Rough-finish	QR	PR	M5 M6 MR6 MR7	NR T3P	RP RN	RP5 RP7	RP GH	MU ME MX	TH THS	GT PH	RT	GR	
		Heavy Turning	QH	HR	RR9	R3P	RH	NRR	HX HV	HU HW HF	TU TUS		HT HY HD HZ	VT VH	
	Positive	Finishing	MM SPL	PF UF	MF2 F1	PF F3P	FP LF	FP4	FP FV LP	LU LB SU	PSF PS PSS	PP XQ	FA FG	VF VL	
		Semi-finishing	TP GP	PM UM	M3 F2	PP SM 14	MP	MP4	MP MV	SF MU	PM	HQ	PC MT	HMP MP C25	
		Rough-finish	KM	PR UR	M5		MF	RP4							
	<b>M</b>	Negative	Finishing	SF YF	MF	MF1	VL SF F3M	FP FS LF	NF4 NMS	FH SH LM	SU EF	SF	MQ GU	EA	HA VP2
			Semi-finishing	SM LM	23 MM QM	M1 MF3 MF4	TF PP M3M	MS MP	NM4	MM MS MA	EX GU	SM	MS MU HU	FG SF EM MP	GS HS MM
			Rough-finish	LR	MR	M5 MF5	NM R3M	RP	NR4 NR5	RM RK GH	EM MU	SH	TK ST	ET	VM RM
Positive		Finishing	MM	UF MF	F1	PF	LF	PM	FM LM	SU	PSF	GQ	FG	HFP VP1	
		Semi-finishing-Roughing	MM GP	UM MM	MF2	SM	MF	PM5	MM MV 无代号	MU	PS PM	MQ	SA	HMP C25	

## Chip Breaker Comparison Table

ISO	Tool Type	Application	GESAC	Sandvik	Seco	Iscar	KennaMetal	Walter	Mitsubishi	Sumitomo	Tungaloy	Kyocera	Taegutec	Korloy
<b>K</b>	Negative	Semi-finishing	MK UK	KF KM	M4	GN	FN UN	MK5	LK MK GK	UZ UX	CF CM 全周	KQ KG C 全周	KT	MK GR VR
		Semi-finishing with Wiper	WMV	WMX WM	W-M3	WG	MW	NM	MW	G UW	SW ASW	WE WQ	WT	LW
		Rough-finish	HK	KR	M5 M6	NR	UN RP	RK5 RK7	GH RK	GZ	CH	KH GC ZS	RT	RK
	Positive	Finishing-Semi-Finishing	MM GP	KF KM		14 19	MF	FK6 MK4	MK 全周	MU	CM	GK		HMP
		Rough-finish	KM	KM KR	M5		MP	RK4 RK6	平板	US	平板		MT	C25
<b>N</b>	Positive	General Machining	AL	AL	AL	AS	HP	PM2	AZ	AG	AL	AH	FL	AK
<b>S</b>	Negative	Finishing-Semi-Finishing	EL SML	SGF	MF1	PP	MS	MS3	MJ	EX	HRF	TK	ML	VP2
	Negative	Semi-finishing	EM SMM	SM	M1	TF	UP	NMS	MS	EG	HRM	MS	MGS	VP3

## Grade Comparison Table

ISO	Coating	Code	GESAC	Sandvik	Seco	Iscar	KennaMetal	Walter	Mitsubishi	Sumitomo	Tungaloy	Kyocera	Taegutec	Korloy
P	CVD	P01	GPT6110 GP1105	GC4205 GC4305	TP0500 TP0501 TP1000	IC9150 IC8150	KCP05B KC9105	WPP05S WPP05	UE6105 UE6005	AC810P	T9205 T9115 T9015	CA510 CA5505	TT8105 TT8115	NC3010
		P10	GPT6110 GP1115 GP1120	GC4215 GC4315 GC4415	TP0500 TP0501 TP1500 TP1501	IC9150 IC8150	KCP10B KC9110 KC9315	WPP10S WPP10	UE6010 UE6110 MC6015	AC810P AC8025P AC820P	T9215 T9115 T9015	CA515 CA5515	TT8105 TT8115	NC3010 NC3215
		P20	GPT6120 GPT6130 GP1120 GP1225	GC4225 GC4325 GC4425	TP1500 TP1501 TP2500 TP2501 TP2000	IC9250 IC8250	KCP25B KC9125 KC9225 KC9325	WPP20S WPP20	UE6120 UE6020 MC6025	AC820P	T9225 T9125 T9025	CA525 CA5525	TT8125 TT8115 TT5100	NC3225 NC3120
		P30	GPT6120 GPT6130 GP1225 GP1130 GP1135	GC4235 GC4335	TP2500 TP2501 TP3501 TP3500	IC635 IC9350 IC8350	KCP30B KC9140 KC9240	WPP30S WPP30	MC6035 UE6035	AC830P AC630M	T9235 T9135	CA530 CA5535	TT8125 TT5100 TT8135 TT7100	NC3030 NC5330
		P40	GP1135	GC4240 GC4335	TP3500 TP40	IC635	KCP40B KC9240	WPP30S WPP30	MC6035 UH6400	AC830P AC630M	T9235 T9135	CA530 CA5535	TT5100 TT8135 TT7100	NC3030 NC5330
	P01											PR1005		
	P10		GC1525 GC1025	CP200 TH1000 TS2000	IC250 IC507 IC570	KCU10 KC5010 KC5510		MS6015 VP10MF		AH710	PR1005 PR1115 PR1215			PC8110
	P20	GM3225	GC1525 GC1020 GC1125 GC1025	CP250 TS2500	IC908 IC928 IC1008 IC1028 IC3028	KCU25 KC5025 KC5525		VP15TF VP20MF	AC520U	AH710 AH330	PR930 PR1025 PR1115 PR1215 PR1425 PR1225	TT9020 TT7010 TT7220	PC5300 PC8115	
	P30	GM3225	GC1125 GC1025	CP500	IC928 IC1008 IC1028 IC3028	KC5525		VP15TF VP20MF	AC530U	GH330 GH730 AH120 AH330 AH740	PR1025 RR1225 PR1535	TT8020 TT9020 TT7220		
	P40	GM3225	GC1145 GC2145	CP500	IC928 IC1008 IC1028	KC5525		VP15TF VP20MF		AH140		TT8020		



## Grade Comparison Table

ISO	Coating Code	GESAC	Sandvik	Seco	Iscar	KennaMetal	Walter	Mitsubishi	Sumitomo	Tungaloy	Kyocera	Taegutec	Korloy		
<b>M</b>	PVD	M10	GM3215	GC1105 GC1115 GC1525		IC520	KCS10	WXM10	VP10RT	AC510U	AH110 AH8005	PR1025 PR1215	TT5080	PC8105	
		M20	GM3220	GC1025 GC1115 GC1125 GC1525	TS2000 TS2500 CP200	IC520 IC507 IC807 IC907	KC5010 KC5510 KCU10	WSM10 WSM10S	VP10RT VP15TF VP20MF VP20RT UP20M	AC520U	AH120 AH630 AH8015 SH725 GH330	PR930 PR1025 PR1125 PR1215 PR1425 PR1225	TT9030 TT8010	PC8110 PC8115	
		M30	GM3220 GM3225	GC1125 GC2035	TS2500 CP200 CP500	IC520 IC507 IC807 IC907 IC308 IC3028	KC5025 KC5525 KCU25	WSM20 WSM21 WSM20S	VP15TF VP20MF VP20RT UP20M MP7035	AC530U AC6040M	AH630 AH725 SH725 SH730 GH730	PR1125 PR1225 PR1535	TT9080 TT8020	PC5300 PC9030	
		M40	GM3225	GC1125 GC2035	CP500 CP600	IC3028 IC308 IC908 IC928	KC5025 KC5525 KCU25	WSM30 WSM30S	MP7035	AC6040M	AH645				PC5400
	CVD	M10	GM1115	GC2015 GC2220		IC9250 IC520M	KCM15B	WAM10	MC7015	AC610M		CA6515	TT9215	NC9115	
		M20	GM1115	GC1515 GC2015 GC2025 GC2220	TM2000 TP200	IC9025 IC9350 IC4050	KCM15B KCM25B	WAM20	MC7015 US7020 MC7025	AC6020M AC630M	T6120	CA6525	TT9215 TT9225	NC9125 NC9025 NC5330	
		M30	GM1125 GM1230	GC2040 GC235	TM2000 TM4000 TP40	IC9350 IC4050 IC635	KCM25B KCM35B	WAM20	MC7025 US735	AC6030M AC630M AC830P	T6130		TT9225 TT9235	NC9135	
		M40	GM1125 GM1230	GC235	TM4000	IC635	KCM35B KCP40B		US735				TT9235		
	<b>K</b>	CVD	K01	GK1115	GC3205	TK1001 TH1500 TK1000	IC5005 IC8150	KCP05B KCP10B KCL05B	WKK10S WAK10	UC5105 MC5005	AC4010K AC405K	T5105	CA310 CA4010 CA4505 CA5505	TT7005	NC6205 NC6210
			K10	GK1115 GK1120	GC3205 GC3210 GC3215	TK1001 TK2001 TK2000 TP0500 TP1500	IC5005 IC5010	KCK15B TN5015B	WKK10S WAK10	UC5105 UC5115 MC5005 MC5015	AC4015K AC405K AC415K	T515 T5105 T5115	CA315 CA4515 CA4010 CA4115 CA4120	TT7005 TT7015	NC6205 NC6210 NC315K
			K20	GK1115 GK1120 GK1125	GC4325 GC3215 GC3220 GC3225	TK2001 TP2500	IC5010	KCK20B KCP25B	WKK10S WKK20S WAK10 WAK20	UC5115 MC5015	AC4015K AC415K AC420K	T5115 T5125	CA315 CA4515 CA4115 CA4120 CA4515	TT7015 TT7310	NC6215 NC315K NC5330 PC5300
			K30	GK1125	GC3040 GC4335	TK2001 TP2500 TP200			WAK30 WKP30S	UC5115 MC5015	AC420K AC820P	T5125	CA320 CA4120		NC5330 PC5300
<b>N</b>	PVD	N01	GN9110 GNT7120	H10 H13A			K605			H1 H2	KS05F	KW10	H01		
		N10	GN9110 GNT7120		890 H15	IC20	K313 K110M THM	WK10	HTi10	EH10 EH510	TH10 H10T	KW10 GW15	K10		
		N20	GN9120 GNT7120		HX KX 883 H15 H25	IC20	K715 KMF K600			G10E EH20 EH520	KS15F		K20		
		N30	GN9130 GNT7120		H25 883		G13 THR								
<b>S</b>		S10	GST7115 GST7120 GS3115	GC1105	TS2000 TS2500	IC807 IC907	KCU10 KC5010	WSM10S	VP10RT MP9015	AC510U AC5015S	AH8015 AH905 SH730 AH110	PR005S PR015S	TT8010	AH8005 AH8015	
		S20	GST7130	GC1115 GC1125	CP500	IC808 IC908	KCU25 KC5025	WSM20S	MP9015	AC510U AC520U AC5025S	AH8015 AH120 AH725	PR015S PR1535	TT8020	AH8015 AH7025	

## Cermets Grade Comparison Table

ISO	Coating	Code	GESAC	Sandvik	Seco	Iscar	KennaMeta	Mitsubishi	Sumitomo	Tungaloy	Kyocera	Taegutec	Korloy
<b>P</b>	None	P01				IC20N	KT1120	NX1010	T110A T1000A	NS520	TN610		CN20
		P10	GP91TM GP92TM	CT5015	TP1020	IC20N IC75T	KT1120 KT175	NX2525	T1200A T1500A	NS520 NS9530	TN610 TN60	CT3000	CN20 CN1000 CN1500
		P20	GP91TM GP92TM	CT5015	TP1020	IC20N IC75T IC30N	KT125	NX2525 NX3035	T1200A T1500A	NS9530 NS530 NS730	TN620 TN90	CT3000	CN1000 CN1500 CN2000
		P30				IC75T IC30N		NX3035 NX4545	T250A	NS740			CN2500
	PVD	P01-P20	GP31TM	GC1525	TP1030	IC520N IC530N	KT315 KTP10	AP25N VP25N MP3025 VP45N	T1500Z T2000Z T3000Z	J530 GT9530 GT530 GT730	PV710 PV720	PV3010	CC1500 CC2500

## PCBN&amp;PCD Grade Comparison Table

ISO	Code	GESAC	Sandvik	Seco	Iscar	KennaMeta	Walter	Mitsubishi	Sumitomo	Tungaloy	Kyocera	Taegutec	Korloy
<b>K</b>	K01	BKN115P BKN120P	CB7525	CBN050C CBN300P	IB50 IB85	KB1630 KB1345	WCB80	MB710	BN500 BNC500 BN7000	BX910 BX930 BX950	KBN475	TB730	KB370
	K10	BKN115P BKN225Z BKN225S	CB50 CB7050	CBN20 CBN200 CBN300	IB55	KB9610	WCB50	MB5015 MB4020	BN7000 BN500	BX470 BX480 BX950	KBN60M KBN900	KB90A	KB350
	K20	BKN115P BKN225Z BKN225S		CBN350 CBN500 CBN600	IB90	KB9640	WCB80	BC5030 MB730 MBS140	BN7000 BNS800	BXC90 BX90S	KBN900		DBS800
<b>H</b>	H01	BHC210P BKN225Z	CB20	CBN050C CBN010 CBN10 CBN100	IB25HC IB20H	KB1610	WCB30	BC8105 MB810	BNC2010 BNC100 BN1000 BN2000 BNX10	BXM10 BX310 BXC30	KBN05M KBM10M KBN510	TB610 KB50	KB410 KB1000
	H10	BHC210P BHC115P BHC215Z BHC125P	CB7105 CB7015 CB50 CB7050	CBN160C CBN150 CBN060K CBN200	IB50	KB9610 KB5610 KB1615 KB1625	WCB50	BC8110 MBC010 MB825	BNC2010 BNC2020 BNC160 BNC200 BN2000	BXM10 BX330	KBN05M KBM10M KBN25M KBN510 KBN525	TB650 KB50	DNC250 KB320 KB2000
	H20	BHC225P BHC125P BHC225Z BHN225S	CB7115 CB7025 CB7525	CBN400C CBN300P CH2540 CBN350 CBN500	IB25HA IB55	KB5625 KB1340	WCB80	BC8120 MBC020 MB8025	BNC2020 BNC200 BNX20	BXM20 BXC50 BX380	KBN25M KBN30M KBN35M KBN900	TB670	KB420
	H30	BHC135P	CB7525	CH3515	IB55	KB9640 KB5630		BC8130 MB835	BNC300 BN350 BNX25	BXM20 BXC50 BXA20	KBN30M KBN35M KBN900	TB730 KB90A	DNC350 KB335 KB425
<b>S</b>	S01	BSN115P		CBN200		KB5630	WCB80	MB4020	BN7000	BX470 BX480	KBN65M KBN70M KBN570 KBN65B	KB90 KB90A	KB370
<b>N</b>	N01		CD05	PCD05		KD1405 PD100		MD205	DA1000 DA90	DX180 DX160	KPD001	TD810	DP200
	N10	DNN125P	CD10	PCD10	ID5	KD1415 KD1400	WD10	MD220	DA1000 DA150	DX140 DX110	KPD001 KPD010 KPD230 KPD250		DP200
	N20	DNN125P		PCD20		KD1425		MD230	DA1000 DA2200	DX120	KPD001 KPD010 KPD230 KPD250	KP300	DP150
	N30			PCD30 PCD30M		KD1400		MD2030	DA1000 DA2200	DX110			DP90

## Small Part Inserts Selection Guide

GAT7115 has good result in machining stainless steel 303 and 304. GAT7145 has a good result in machining medium to high hardness stainless steel such as 316L. GAT7120A is better for machining ordinary steel and free-cutting steel

### Carbide coating series

Working Condition	GESAC	Kyocera	NTK	Sumitomo	TaeguTec	Mitsubishi	Tungaloy
High Speed machine	GAT7115	PR1225	DM4/DT4/ST4	AC5015S AC520U			AH725
Low speed wear resistant	GAT7120	PR930	TM4/ZM3/QM3	AC1030U		VP15TF	
Light continuous machining	GAT7125	PR1535	TM4/QM3	AC5025S	TT9020		SH730
General steel machining	GAT7120A	PR1725	TM4/ZM3/QM3				
Easy cutting steel		PR1705	VM1				

## Small Part Inserts Selection Guide

### Turning Geometry

Product Series	Product geometry						
	GESAC	Kyocera	NTK	Tungaloy	Sumitomo	Mitsubishi	TaeguTec
General grooving series	negative-P	S	KHG/K	W	FY	F	
	positive-P	F	KHG/K	W	FY	F	
	G	U	UHG/U·U1	JPP	FX	SS	
	S	Y	UHG/U·U1				
3D chip-breaker series	AF	CF	AMX				
	AK	SK/SKS	UL	JS			SA
	BF	GF	AZ7/YL/AM3		FC/SI		
	BK	CK	CL	JS			
	MM	GQ	YL		SC/SI		
Back turning series	GSAB	ABS	TBP		SBT		
	GSTB	TKFB		JXB JTB		BTAT	

Series	Feature	Geometry	Recommended operating conditions
General grooving series	1.Divided into left and right hand, choose according to working conditions 2.Sharp cutting edge, effectively reducing cutting force 3.Universal for external turning, small cut depth end face turning	P	Chute design suitable for small cut depth with good chip breakage
		G	Large rake angle and long straight flute design meet the requirement for small feed and large cut depth machining condition
		S	edge inclination, long straight flute design, good chip guide effect, suitable for small parts machining for finishing and semi-finishing conditions
3D chip-breaker series	1.Compatible with left and right hand 2.Handle chip breakage with varying feed and cut depth 3.suitable for external and end face turning	AF	Small flute width, large rake angle design, suitable for very small cut depth of 0.02-0.2mm, good chip breakage performance and machined surface
		AK	Sharpe edge, edge inclination design to achieve variable cut depth with good chip guidance and removal performance, good machined surface
		BF	Special chip breaker, small rake angle design, suitable for small cut depth, good chip removal performance, high strength cutting edge for general processing
		BK	Large flute width, edge inclination design, good chip removal performance and machined surface
		MM	Dual rake angle, hyperboloid chip breaker design, suitable for a wide range of machining conditions, good chip removal performance suitable for rough machining for small parts

## Small Part Inserts Selection Guide

### Grooving

Product Series	Product category	GESAC	Kyocera	NTK	TaeguTec	Mitsubishi	Tungaloy	Korloy	Iscar
Shallow groove	Three-edged shallow groove	Custom GB	TGF GBA	GTMH		GTAH	JSTG	TBGF	
Deep groove	—	GKD	KGM	KGWP		GY2M	JCTE		
Grinding cut	Vertical mounted (General)	GSTC	TKF	CTP		CTAH	JXGR	SBC	SCH
	Vertical mounted (slim)	GSTS	TKFS						
Compression cut	Slotted	GTD	GDM	CDTP	TDJ	GY	JCGWS	MGMN	DGN

Series	Lead angle selection	Feature	Geometry	Recommend operating condition
GSTC	The insert without lead angle can effectively prevent the edge breaking and chip winding, better tool life; the insert with lead angle can reduce the core of the solid rod, prevent residual and deformation of the hollow tube	For conventional cutting tools, the right hand tool holder is generally used, the left hand tool is mainly used when there is a sub-axis to assist in clamping the work piece for cutting	U	Large rake angle, small nose radius, good sharpness, effectively optimize the surface quality of the work piece.
			T	Reinforced insert, large nose radius and relatively small rake angle ensure the strength of the cutting edge and improve tool life
			N	Large flat flute, no nose design, effectively improves tool life while ensuring the edge sharpness
GSTS		Mainly used when the sub-spindle assists in clamping and cutting, and small diameter of the workpiece, and the overhang depth of the main shaft is restricted, thin blade is suitable for machining in confined spaces	U	Large rake angle, small nose design, good sharpness, effectively optimize the surface quality of the work piece
GSTT		Conventional thread cutter are generally suitable for general 55° and general 60° thread	-	Sharp rake angle design, suitable for small parts thread machining.

### Thread

Product Series	Product category	GESAC	Kyocera	NTK	Tungaloy	Iscar
Vertically mounted	Two-edged	GSTT	TKFT	TTP	JSXB	SCI

## List of Holder Parts Specifications (Shim)

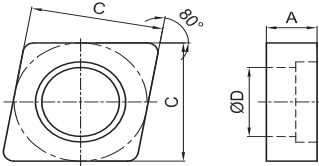
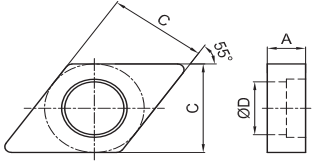
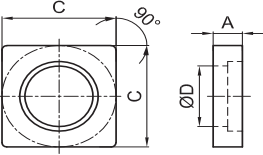
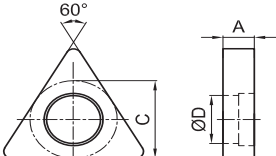
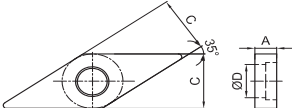
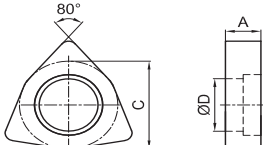
Geometry	Ordering code	Dimension							Suitable tool
		A	B	C	D	E	F	$\alpha^\circ$	
	DCN1204MH	4.76		12.4	7.4				External-M Type
	DCN1604MH	4.76		15.6	9.8				
	DCN1904MH	4.76		18.6	11.6				
	DDN1103MH	3.3		9.2	5.9				External-M Type
	DDN1504MH	4.76		12.4	7.4				
	DSN1204MH	4.76		12.4	7.4				External-M Type
	DSN1504MH	4.76		15.6	9.8				
	DSN1904MH	4.76		18.6	11.6				
	DTN1603MH	3.3		9.2	5.9				External-M Type
	DTN2204MH	4.76		12.4	7.4				
	DVN1603MH	3.3		9.2	5.9				External-M Type
	DWN0603MH	3.3		9.2	5.9				External-M Type
	DWN0804MH	4.76		12.4	7.4				

## List of Holder Parts Specifications (Shim)

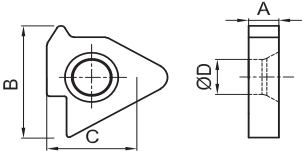
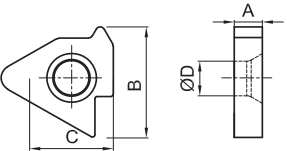
Geometry	Ordering code	Dimension							Suitable tool
		A	B	C	D	E	F	$\alpha^\circ$	
	DEN16P15SH	3.21	14.21	9.525	3.5				PSER/L*16*
	DEN22P15SH	4.019	18.474	12.7	4.0				PSER/L*22*
	DEN27P15SH	4.748	24.428	15.875	5.0				PSER/L*27*
	DIN16P15HC	3.21	14.21	9.525	3.5				PSIR/L*16*
	DIN22P15HC	4.019	18.474	12.7	4.0				PSIR/L*22*
	DIN27P15HC	4.748	24.428	15.875	5.0				PSIR/L*27*

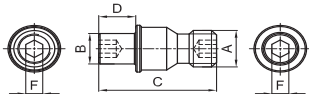
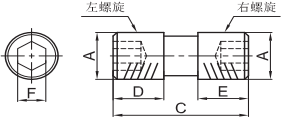
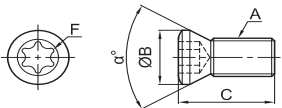

## List of Holder Parts Specifications (Screws)

Geometry	Ordering code	Dimension							Suitable tool
		A	B	C	D	E	F	$\alpha^\circ$	
	SPM050130H	M5X0.8	3.7	13.2	5		2		External-M Type
	SPM060170H	M6X1.0	5	17.2	5.5		2.5		
	SPM060190H	M6X1.0	5	18.8	7.1		2.5		
	SPM080220FH	M8X1.0	6.2	21.8	6.7		3		
	SPM100240FH	M10X1.0	7.7	23.5	7		4		
	SDM060200H	M6X1.0		20	7	7	3		External-M Type
	SDM060250H	M6X1.0		25	9	9	3		
	SDM060280H	M6X1.0		28	9	9	3		
	SDM080350FH	M8X1.0		35	11	11	4		
	SI60M022060-03008H	M2.2X0.4	3.0	6			TT06	60	External-S Type Internal-S Type
	SI60M025060-03510H	M2.5X0.45	3.5	6			TT08	60	
	SI60M040100-05812H	M4X0.7	5.5	10			TT15	60	
	SI60M050120-07012H	M5X0.8	7.2	12			TT20	60	Small parts External-S Type
	PSI60M020050-02806S	M2.0X0.4	2.8	5			TT06	60	
	SI60M025065-03509S	M2.5X0.45	3.5	6.5			TT07	60	
	SI60M030072-04210S	M3X0.5	4.2	7.2			TT09	60	
	SI60M040089-05313S	M4X0.7	5.3	8.4			TT15	60	
	SSAM045070Q	M4.5X0.5	6	6.8			TT10	57	

## List of Holder Parts Specifications (Screws)

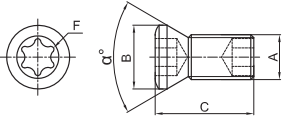
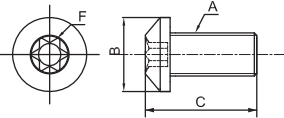
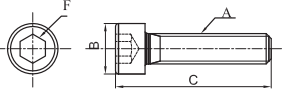
Geometry	Ordering code	Dimension							Suitable tool
		A	B	C	D	E	F	$\alpha^\circ$	
	SSAM045095Q	M4.5X0.75	6	9.45			TT10	57	GSTR/L*
	SSBM030060H	M3X0.5	5.5	8.5			TT15		PSER/L*16*
									PSIR/L*16*
	SSBM040060H	M4X0.7	7.8	8			TT20		PSER/L*22*
									PSIR/L*22*
									PSER/L*27*
	SCAM040120H	M4X0.7	5.5	14.4			TH30		PGNSR/L1616*
									PGNSR/L2020*
									PGNSR/L2525*
									PGKIR/L2016*
									PGKIR/L2520*
	SCAM050120H	M5X0.8	8.5	15.5			TH20		PGKER/L1616*
	SCAM050200H	M5X0.8	8.5	23.5			TH40		PGNSR/L2020*
									PGNSR/L2525*
									PGKIR/L2925*
									PGKIR/L3125*
								PGKIR/L3723*	
								PGKIR3723*	
								PGKIR/L4540*	
SCAM060200H	M6X1	9.8	26			TH50		PGKFR/L*	
SCAM060300H	M6X1	9.8	36			TH50		PGZER/L2525*	
								PGZER/L3225*	

## List of Holder Parts Specifications (Press Plate)

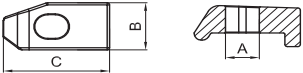
Geometry	Ordering code	Dimension							Suitable tool	
		A	B	C	D	E	F	$\alpha^\circ$		
	CAM01H	M5X0.8	11.2	14.7					External-M Type	
	CAM02H	M6X1.0	14	18.5						
	CAM03H	M6X1.0	14	21.5						
	CAM04H	M6X1.0	14	24						
	CAM05H	M8X1.0	19	25						
	CAN02RH	5.44	11.2	21.9					PGNSR1616*	
									PGNSR2020*	
									PGNSR2525*	
	CAN03RH	5.76	8.7	13.6						PGNSR2020*
										PGNSR2525*
	CAN02LH	5.44	11.2	21.9						PGNSL1616*
PGNSL2020*										
PGNSL2525*										
CAN03LH	5.76	8.7	13.6						PGNSL2020*	
									PGNSL2525*	

## List of Holder Parts Specifications (Wrench)

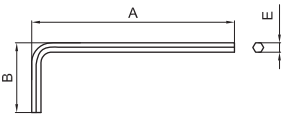
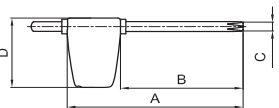
Geometry	Ordering code	Dimension							Suitable tool
		A	B	C	D	E	F	$\alpha^\circ$	
	TH20LH	54	19			2			External-M Type
	TH25LH	59	19			2.5			
	TH30LH	64	22			3			
	TH40LH	73	28			4			
	TH50LH	85	28.5			5			PGKER/L2525*
	TT06PH	81	50	T6	22				External-S Type Internal-S Type
	TT08PH	84	50	T8	22				
	TT15PH	85	50	T15	27				
	TT20PH	88	53	T20	29				
	TT06PQ	51	35	T6	15				Small parts External-S Type
	TT07PQ	54	35	T7	19				
	TT09PQ	60	40	T9	24				
	TT15PQ	66	45	T15	28				





---

## **XIAMEN GOLDEN EGRET SPECIAL ALLOY CO.,LTD.**

Add: No.69 Xinglong Road Huli District Xiamen CHINA  
Factory Add: No.1601-1629 Jicheng Road Industrial  
Concentration Area Tongan Xiamen CHINA  
Tel: +86-592-7107392  
Fax: +86-0592-7107322  
P C : 361006  
Email: GJ.GLB@CXTC.COM

[www.gesac.net](http://www.gesac.net)

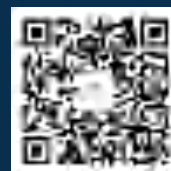

GE202306ae

---